

“J”

Traffic Study

FINAL TRAFFIC IMPACT REPORT

VIDA VALIENTE WINERY

USE PERMIT 2020

407 Crystal Springs Road

St. Helena, CA 94574

APN: 021-410-013-000

Project No. P-20-00079

September 7, 2021

Prepared for: VIDA VALIENTE WINERY

Prepared by: CRANE TRANSPORTATION GROUP

Mark D. Crane, President

California Registered Traffic Engineer (#1381)

2621 East Windrim Court

Elk Grove, CA 95758

(916) 647-3406

cranetransgroup@gmail.com

TABLE OF CONTENTS

I. INTRODUCTION1

II. EXECUTIVE SUMMARY OF PROJECT IMPACTS AND RECOMMENDED IMPROVEMENTS1

 A. Impacts..... 1

 B. Recommended Improvements 3

III. SUMMARY OF “WITHOUT AND WITH PROJECT” OPERATING CONDITIONS3

 A. “Without Project” Operating Conditions 3

 B. Project Impacts 4

 C. Recommended Improvements 6

 D. Conclusions & Recommendations..... 7

IV. PROJECT LOCATION & DESCRIPTION8

V. EXISTING CIRCULATION SYSTEM EVALUATION PROCEDURES.....9

 A. Analysis Locations 9

 B. Volumes..... 9

 C. Roadways 10

 D. Intersection Level Of Service..... 11

 E. Arterial Level Of Service 12

 F. Intersection Signal Warrants..... 12

 G. Planned Improvements 13

 H. Accident History 13

 I. Existing Pedestrian And Bicycle Facilities Near The Project..... 13

 J. Transit Service 13

VI. FUTURE HORIZON TRAFFIC VOLUME PROJECTIONS.....14

VII. OFF-SITE HARVEST CIRCULATION SYSTEM OPERATION – WITHOUT PROJECT15

 A. Year 2019 Harvest (Without Project) Operating Conditions..... 15

 B. Year 2025 Harvest (Without Project) Operating Conditions..... 16

 C. Cumulative (Year 2030) Harvest (Without Project) Operating Conditions..... 17

VIII. SIGNIFICANCE CRITERIA18

 A. County Of Napa 18

IX. PROJECT IMPACT EVALUATION21

 A. Trip Generation 21

 B. Trip Distribution 22

 C. Off-Site Impacts..... 22

TABLE OF CONTENTS

X. OTHER POTENTIAL PROJECT IMPACTS28

- A. Winery Driveway Sight Lines At Crystal Springs Road..... 28
- B. Left-Turn Lane At Crystal Springs Road/Winery Main Driveway Intersection 29
- C. Marketing Events 29
- D. Pedestrian, Bicycle And Transit Impacts 29
- E. Transportation Demand Management (TDM) Plan & Vehicle Miles Traveled (VMT) Reductions..... 30
- F. On-Site Parking & Internal Circulation 30
- G. Yearly Trip Generation 31
- H. Width Of Crystal Springs Road 31

XI. RECOMMENDED IMPROVEMENTS.....31

XII. CONCLUSIONS & RECOMMENDATIONS31

ATTACHMENTS

- TABLES 1-6
- FIGURES 1-21
- APPENDICES A-G

I. INTRODUCTION

This report has been prepared at the request of the proposed Vida Valiente Winery applicant to determine whether the proposed Winery, as detailed in their 2020 use permit application, will result in any significant circulation impacts to the local roadway network. The project site is located on the west side of Crystal Springs Road about a mile north of Sanitarium Road. (See **Figure 1 Regional Map**, **Figure 2 Site Specific Air Photo** and **Figure 3 Site Plan**.) The scope of analysis includes evaluation of Silverado Trail and Crystal Springs Road as well as the Silverado Trail intersections with Crystal Springs Road and Deer Park Road, the Sanitarium Road intersections with Deer Park Road and Crystal Springs Road, and the Crystal Springs Road intersections with North Fork Crystal Springs Road and the proposed Winery Main Driveway for harvest 2019, 2025 and Cumulative (Year 2030) horizons. The Scope of Service for this traffic study was developed for and approved by the Napa County Public Works Department.

II. EXECUTIVE SUMMARY OF PROJECT IMPACTS AND RECOMMENDED IMPROVEMENTS

A. IMPACTS

1. PROPOSED PROJECT HARVEST FRIDAY & SATURDAY PM PEAK HOUR TRIP GENERATION

PM PEAK HOUR TWO-WAY TRIPS	
HARVEST FRIDAY	HARVEST SATURDAY
14	10

2. SIGNIFICANCE OF PROJECT IMPACTS

a. INTERSECTION LEVEL OF SERVICE

Less than significant.

(Silverado Trail at Crystal Springs Road & Deer Park Road + Sanitarium Road at Deer Park Road & Crystal Springs Road + Crystal Springs Road at North Fork Crystal Springs Road & Winery Main Driveway)

b. ARTERIAL LEVEL OF SERVICE

Less than significant.

(Silverado Trail North and South of Crystal Springs Road)

c. NEED FOR LEFT-TURN LANE ON THE NORTHBOUND CRYSTAL SPRINGS ROAD APPROACH TO THE WINERY MAIN DRIVEWAY

Less than significant - A left turn lane is not warranted with Cumulative + project traffic.

d. SIGHT LINE ADEQUACY AT CRYSTAL SPRINGS ROAD/WINERY DRIVEWAY INTERSECTIONS

Less than significant - Sight lines at the north and south driveway intersections with Crystal Springs Road meet Caltrans stopping sight distance criteria in both directions.

e. MARKETING EVENTS

Less than significant - The marketing program is proposing 28 events. During days with midsize events occurring 2 or more times per month, the number of visitors by appointment will be reduced by the number of guests at the marketing event.

f. PEDESTRIAN, BICYCLE AND TRANSIT IMPACTS

Less than significant - No pedestrians are anticipated as there are no pedestrian paths along Crystal Springs Road or any other local roadway. No transit ridership by employees is anticipated as there is no service along Silverado Trail, Crystal Springs Road or Sanitarium Road. Class II bicycle lanes are provided along Silverado Trail and Deer Park Road (Silverado Trail to SR 29) and bicycle racks will be provided for all employees or guests biking to the site.

g. PARKING & INTERNAL CIRCULATION

Less than significant - Parking space layout and internal roadway design will meet County and CAL FIRE Standards. A total of 11 parking spaces will be provided for employees and guests.

h. TRANSPORTATION DEMAND MANAGEMENT (TDM) PLAN AND VEHICLE MILES TRAVELED (VMT) REDUCTION

Less than significant - A TDM coordinator will be appointed to develop programs to provide incentives for employees to carpool or bicycle to work. In addition, shuttle bus service will be provided at all large marketing events (with 60 or more guests). A TDM plan is attached.

i. CRYSTAL SPRINGS ROAD

Informational purposes only - Crystal Springs Road now meets County rural road criteria to have a 20-foot pavement width in many locations between Silverado Trail and the Winery (to the north of the site). Widths range from 16 to 24 feet. Project promotional material, signing at the Silverado Trail/Crystal Springs Road intersection and signing for exiting vehicles would encourage project traffic to use this segment of Crystal Springs Road for access. South of the project site (to Sanitarium Road) the width of Crystal Springs Road ranges from 12 to 18 feet the majority of the distance. A minor amount of project traffic would potentially travel on this section of Crystal Springs Road (2 vehicles per hour during business hours).

B. RECOMMENDED IMPROVEMENTS

No off-site circulation system improvements are required at analyzed intersections or along Silverado Trail.

In order to minimize project traffic along the narrower sections of Crystal Springs Road (which are mostly south of the Winery) all promotional information and driving directions provided to guests should show only the Crystal Springs Road connection to Silverado Trail north of the site as the project access route. Also, a sign with the Winery's name will be provided on Silverado Trail at the Crystal Springs Road intersection. Finally, signs will be provided along Winery Driveways for outbound drivers with an arrow pointing north and a message indicating to make a left turn for access to Silverado Trail.

III. SUMMARY OF "WITHOUT AND WITH PROJECT" OPERATING CONDITIONS

A. "WITHOUT PROJECT" OPERATING CONDITIONS

1. INTERSECTION LEVEL OF SERVICE

- a. **SILVERADO TRAIL/DEER PARK ROAD – All Way Stop**
 - **Friday & Saturday PM Peak Hours**
Existing, Year 2025 & Cumulative (2030) – **Unacceptable**
- b. **SILVERADO TRAIL/CRYSTAL SPRINGS ROAD - Stop sign controlled Crystal Springs Road approach**
 - **Friday & Saturday PM Peak Hours**
Existing, Year 2025 & Cumulative (2030) - Acceptable
- c. **SANITARIUM ROAD/DEER PARK ROAD - Stop sign controlled Sanitarium Road approach**
 - **Friday & Saturday PM Peak Hours**
Existing, Year 2025 & Cumulative (2030) - Acceptable
- d. **SANITARIUM ROAD/CRYSTAL SPRINGS ROAD - Stop sign controlled Crystal Springs Road approach**
 - **Friday & Saturday PM Peak Hours**
Existing, Year 2025 & Cumulative (2030) - Acceptable
- e. **CRYSTAL SPRINGS ROAD/NORTH FORK CRYSTAL SPRINGS ROAD - North Fork yield sign controlled approach**
 - **Friday & Saturday PM Peak Hours**
Existing, Year 2025 & Cumulative (2030) – Acceptable

- f. **CRYSTAL SPRINGS ROAD/WINERY MAIN DRIVEWAY - Driveway Approach**
 - **Friday & Saturday PM Peak Hours**
Existing, Year 2025 & Cumulative (2030) - Acceptable

2. ARTERIAL LEVEL OF SERVICE

- a. **SILVERADO TRAIL NORTH & SOUTH OF CRYSTAL SPRINGS ROAD**
 - **Friday & Saturday PM Peak Hours**
Existing, Year 2025 & Cumulative (2030) – Acceptable

3. INTERSECTIONS WITH VOLUMES MEETING PEAK HOUR SIGNAL WARRANT #3 RURAL CRITERIA

- a. **SILVERADO TRAIL/DEER PARK ROAD**
 - **Friday & Saturday PM Peak Hours**
Existing, Year 2025 & Cumulative (2030)

4. LEFT TURN LANE VOLUME WARRANT ON NORTHBOUND CRYSTAL SPRINGS ROAD APPROACH TO PROJECT DRIVEWAY

Daily volumes at this intersection do not meet County Warrant Criteria for provision of a left turn lane.

B. PROJECT IMPACTS

1. OFF-SITE

- a. **INTERSECTION LEVEL OF SERVICE IMPACTS**
Less than significant
Friday & Saturday PM Peak Hours

1) Silverado Trail/Deer Park Road

- **Existing, Year 2025 & Cumulative (2030)** – All way stop operation would remain an **unacceptable** LOS E or F with the addition of project traffic. However, project traffic would not increase all-way stop delay by 5 seconds or greater (the County significance criteria).

2) Silverado Trail/Crystal Springs Road

- **Existing, Year 2025 & Cumulative (2030)** – Stop sign controlled operation would remain an acceptable LOS B or C with the addition of project traffic during both the Friday and Saturday PM peak hours.

3) Sanitarium Road/Deer Park Road

- **Existing, Year 2025 & Cumulative (2030)** - Stop sign and yield controlled operation would remain an acceptable LOS A or B with the addition of project traffic during both the Friday and Saturday PM peak hours.

4) Sanitarium Road/Crystal Springs Road

- **Existing, Year 2025 & Cumulative (2030)** - Stop sign controlled operation would remain an acceptable LOS A or B with the addition of project traffic during both the Friday and Saturday PM peak hours.

5) Crystal Springs Road/North Fork Crystal Springs Road

- **Existing, Year 2025 & Cumulative (2030)** - Yield controlled operation would remain an acceptable LOS A with the addition of project traffic during both the Friday and Saturday PM peak hours.

6) Crystal Springs Road/Winery Main Driveway

- **Existing, Year 2025 & Cumulative (2030)** - Stop sign controlled operation would be an acceptable LOS A with the addition of project traffic during both the Friday and Saturday PM peak hours.

b. ARTERIAL LEVEL OF SERVICE IMPACTS

Less than significant

Friday & Saturday PM Peak Hours

1) Silverado Trail North & South of Crystal Springs Road

- **Existing, Year 2025 & Cumulative (2030)** - The addition of project traffic would not increase volumes to unacceptable levels. Operation would remain and acceptable LOS B or C.

c. NEED FOR LEFT-TURN LANE ON THE NORTHBOUND CRYSTAL SPRINGS ROAD APPROACH TO THE WINERY MAIN DRIVEWAY

Less than significant - Cumulative + project daily volumes at this intersection would not meet current County Warrant Criteria for provision of a left turn lane on the northbound Crystal Springs Road intersection approach.

d. SIGHT LINE ADEQUACY AT CRYSTAL SPRINGS ROAD/WINERY DRIVEWAY INTERSECTIONS

Less than significant - Sight lines at the north and south Winery Driveway intersections with Crystal Springs Road meet Caltrans stopping sight distance criteria in both directions.

e. MARKETING EVENTS

Less than significant - There will be a total of 28 marketing events. There will be 2 per month with up to 24 guests, 3 per year with up to 60 guests, and 1 per year with up to 125 guests. On days with events occurring 2 or more times per month, daily visitation by appointment will be lowered an amount equal to attendance at the marketing event.

f. PEDESTRIAN, BICYCLE AND TRANSIT IMPACTS

Less than significant - No pedestrians are anticipated as there are no pedestrian paths along Crystal Springs Road or any other local roadway. No transit ridership by employees is anticipated as there is no service along Silverado Trail, Crystal Springs Road or Sanitarium Road. Class II bicycle lanes are provided along Silverado Trail and Deer Park Road (Silverado Trail to SR 29) and bicycle racks will be provided for all employees or guests biking to the site.

g. ON-SITE PARKING & INTERNAL CIRCULATION

Less than significant - A total of 11 parking spaces will be provided for employees and guests. One of the 11 spaces will be ADA designated. Visitation is scheduled throughout the day such that the spaces will be adequate. Internal circulation and parking layouts will be designed to meet all County and CAL FIRE criteria.

h. TDM PROGRAM AND VMT REDUCTION

Less than significant - A TDM coordinator will be appointed to develop programs to provide financial incentives for employees to carpool or bicycle to work. In addition, shuttle bus service will be provided at all large marketing events (with 100 or more guests). A TDM plan is attached.

i. CRYSTAL SPRINGS ROAD

Informational purposes only - Crystal Springs Road now meets County rural road criteria to have a 20-foot pavement width in many locations between Silverado Trail and the Winery (to the north of the site). Widths range from 16 to 24 feet. Project promotional material, signing at the Silverado Trail/Crystal Springs Road intersection and signing for exiting vehicles would encourage project traffic to use this segment of Crystal Springs Road for access. South of the project site (to Sanitarium Road) the width of Crystal Springs Road ranges from 12 to 18 feet the majority of the distance. A minor amount of project traffic would potentially travel on this section of Crystal Springs Road (2 vehicles per hour during business hours).

C. RECOMMENDED IMPROVEMENTS

No off-site circulation system improvements are required at analyzed intersections or along Silverado Trail.

In order to minimize project traffic along the narrower sections of Crystal Springs Road (which are mostly south of the Winery) all promotional information and driving directions provided to guests should show only the Crystal Springs Road connection to Silverado Trail north of the site as the project access route. Also, a sign with the Winery's name will be provided on Silverado Trail at the Crystal Springs Road intersection. Finally, signs will be provided along Winery Driveways for outbound drivers with an arrow pointing north and a message indicating to make a left turn for access to Silverado Trail.

D. CONCLUSIONS & RECOMMENDATIONS

- The project will result in no significant off-site circulation system operational impacts to Silverado Trail or to the Silverado Trail intersections with Deer Park Road and Crystal Springs Road, the Sanitarium Road intersections with Deer Park Road and Crystal Springs Road, and the Crystal Springs Road intersections with North Fork Crystal Springs Road and the Winery Driveways.
- A left-turn lane is not warranted on the northbound Crystal Springs Road approach to the Project Driveway.
- Sight lines at the Winery North and South Driveway connections to Crystal Springs Road are acceptable in both directions and meet Caltrans stopping sight distance criteria.
- No pedestrians nor transit users are expected at the Winery. However, bicycle racks will be provided for any bike riders accessing the Winery area via the Class II bike lanes along Silverado Trail or Deer Park Road west of Silverado Trail.
- Internal circulation will be designed to meet County and CAL FIRE criteria. In addition, 11 parking spaces will be provided for guests and employees.
- A total of 28 marketing events are being proposed, and on days with medium size (24 guest) marketing events which will occur 2 times per month), daily visitation by appointment will be reduced by the same amount as the number of guests at the marketing event.
- A TDM coordinator will be appointed to institute measures to reduce daily and peak hour employee traffic as well as increase limousine and shuttle bus service for large marketing events. The attached TDM Plan will be adopted.
- Crystal Springs Road ranges in width from about 16 to 24 feet north of the Winery, and from about 12 to 18 feet south of the Winery. However, in order to minimize project traffic along the narrower sections of Crystal Springs Road (which are mostly south of the Winery) all promotional information and driving directions provided to guests will only show the Crystal Springs Road connection to Silverado Trail north of the site as the project access route. Also, a sign with the Winery's name will be provided on Silverado

Trail at the Crystal Springs Road intersection. Finally, signs will be provided along both Winery Driveways for outbound drivers with an arrow pointing north and a message indicating to make a left turn to for access to Silverado Trail.

IV. PROJECT LOCATION & DESCRIPTION

The Vida Valiente Winery site is located on the west side of Crystal Springs Road about 5800 feet north of Sanitarium Road and about 5600 feet south of Silverado Trail. The proposed use permit will have the following characteristics:

- Yearly production will be 30,000 gallons.
- 169 tons of grapes will be on haul.
- Bottling will be on site.
- Non-harvest employee totals will be 5 full time and 2 part time on Friday, with 2 full time and 2 part time on Saturday.
- Harvest maximum employee totals will be 5 full time and 4 part time on Friday, with 2 full time and 4 part time on Saturday.
- Maximum daily visitation will be 28 guests, with a weekly maximum of 120 guests.
- Tours and tasting will be 7 days/week, 10:00 AM - 6:00 PM.
- Three sizes of marketing events are proposed:
 - 2 per month with 24 guests
 - 3 per year with 60 guests
 - 1 per year with 125 guests
- A total of 11 parking spaces will be provided for guests and employees.
- Internal circulation and parking layout will meet County and CAL FIRE design criteria.
- Two driveway connections will be provided to Crystal Springs Road. The North (Main) Driveway will provide two-way traffic flow and be located at the existing site main access. A South Driveway will also be provided for one-way outbound delivery truck egress and connect to Crystal Springs Road just north of the project's southern boundary.
- Signs will be posted on both driveways directing exiting drivers to turn left for access back to Silverado Trail.

V. EXISTING CIRCULATION SYSTEM EVALUATION PROCEDURES

A. ANALYSIS LOCATIONS

1. INTERSECTIONS

The following locations have been evaluated.

- a. **SILVERADO TRAIL/DEER PARK ROAD**
(All Way Stop)
- b. **SILVERADO TRAIL/CRYSTAL SPRINGS ROAD** (The Crystal Springs Road westbound approach is stop sign controlled)
- c. **SANITARIUM ROAD/DEER PARK ROAD** (The Sanitarium Road southbound approach is stop sign controlled for left turns and yield controlled for right turns)
- d. **SANITARIUM ROAD/CRYSTAL SPRINGS ROAD** (The Crystal Springs Road southbound approach is stop sign controlled)
- e. **CRYSTAL SPRINGS ROAD/NORTH FORK CRYSTAL SPRINGS ROAD** (The North Fork Crystal Springs Road westbound approach is yield sign controlled)
- f. **CRYSTAL SPRINGS ROAD/PROJECT DRIVEWAY INTERSECTION** (The driveway approach will be stop sign controlled)

Figure 4 presents a schematic of approach lane geometrics and control at each analysis intersection.

2. ARTERIAL ROADWAY SEGMENTS

The following locations have been evaluated.

- a. **SILVERADO TRAIL NORTH AND SOUTH OF CRYSTAL SPRINGS ROAD**

B. VOLUMES

1. ANALYSIS SEASONS AND DAYS OF THE WEEK

Project traffic impacts have been evaluated during harvest conditions based upon direction from Napa County Public Works. More than four years of historical information from Caltrans PeMS (Performance Measurement System) count surveys along SR 29 in the Napa Valley show that, September has the highest daily volumes of the year (during harvest). Therefore, only September harvest conditions were selected for evaluation.

In regard to the peak traffic days of the week, Napa County Public Works also specifies that Friday and Saturday are the days of the week to evaluate. *The Napa County Travel Behavioral Study 1 (Fehr & Peers, December 8, 2014)* shows that the highest weekday volumes in Napa Valley occur on a Friday, with the

highest weekend volumes occurring on a Saturday. In addition, historical count data from the City of Napa show that Friday has the highest volumes of any weekday, while Caltrans historical counts for SR 29 between St. Helena and Napa also show that weekday AM and PM peak hour volumes are higher on a Friday than on either a Wednesday or Thursday. Therefore, Friday and Saturday peak traffic conditions were evaluated in this study.

2. COUNT RESULTS

Friday 2:00 to 6:00 PM as well as Saturday Noon to 6:00 PM turn movement counts were conducted by Crane Transportation Group (CTG) for a Friday and Saturday in September 2018 at 4 of the 6 study intersections [(Silverado Trail at Deer Park Road & Crystal Springs Road + Crystal Springs Road at North Fork Crystal Springs Road & the driveway serving a residence on the project site (which would become the Winery Driveway)]. Based upon these counts, the peak traffic hours for the system were determined to be 3:15 to 4:15 PM on Friday and 2:45 to 3:45 PM on Saturday. It should be noted, however, that there were many hours on both days that had similar volumes. After review of the proposed project in 2020 County public works also requested counts and analysis at 2 additional intersections: Sanitarium Road at Deer Park Road and Crystal Springs Road. Counts were conducted at both intersections on two Fridays and two Saturdays in late January and early February 2021. In addition, counts were also conducted on both Fridays and Saturdays at the Silverado Trail/Deer Park Road intersection in order to develop seasonal and COVID lockdown adjustments for the Sanitarium Road counts to increase them to reflect harvest conditions. Raw data counts are presented in **Appendix A**.

Evaluation of the harvest 2018 and January-February counts at the Silverado Trail/Deer Park Road intersection showed 2021 volumes were significantly lower on Silverado Trail north and south of Deer Park Road as well as on Deer Park Road West of Silverado Trail. However, both Friday and Saturday PM peak hour volumes were almost the same on Deer Park Road East of Silverado Trail as harvest 2018 volumes. Based upon this finding and due to the close proximity along Deer Park Road of the Silverado Trail and Sanitarium Road intersections it was determined that seasonable adjustments could be made to the new 2021 counts along Sanitarium Road to reflect harvest conditions. Resultant **Figures 5 and 6** present 2019 harvest Friday and Saturday PM peak hour volumes.

Daily (24-hour) directional volume classification counts and speed surveys were also conducted on a Friday and Saturday in 2021 along Crystal Springs Road at the project site. No daily counts were conducted on the Project Site Driveway as the residence and vineyards on the site had been destroyed by fire in the fall of 2020. See **Appendix A**.

C. ROADWAYS

Roadway descriptions are based upon the designation that Silverado Trail and most of Crystal Springs Road run in general north-south directions through the project area, while Deer Park Road, Sanitarium Road, North Fork Crystal Springs Road and the Project Driveway run in an east-west direction. The project site is located along the west side of Crystal Springs Road about a mile north of Sanitarium Road. **Figure 4** presents Existing intersection geometrics and control.

Silverado Trail in the project vicinity has two well-paved 12-foot travel lanes and wide paved shoulders that are utilized as Class II bicycle lanes. A left turn lane is not provided on the southbound Silverado Trail approach to Crystal Springs Road. The posted speed limit is 55 miles per hour at Crystal Springs Road. Silverado Trail has an all-way stop intersection with Deer Park Road with all approaches providing a combined through-left turn lane and an exclusive right turn lane. A flashing red light is provided for all approaches.

Crystal Springs Road is a rural road extending easterly from Silverado Trail for about 800 feet and then southerly for about 2 miles to Sanitarium Road. It is stop sign controlled on its approach to both roads. Crystal Springs Road is about 20 feet wide just east of Silverado Trail, ranges from 16 to 24 feet wide north of the project site and 12 to 18 feet wide between the project site and Sanitarium Road - See **Figure 7**. Signs are posted on Crystal Springs Road just north of Sanitarium Road and east of Silverado Trail stating "Narrow Winding Road Next 2 Miles" with 25 mile-per-hour speed limit signs. The road has no centerline and intermittent gravel or dirt shoulder areas.

Sanitarium road is a well-paved two-lane facility with a posted 35-mile per hour speed limit.

D. INTERSECTION LEVEL OF SERVICE

1. ANALYSIS METHODOLOGY

Transportation engineers and planners commonly use a grading system called level of service (LOS) to measure and describe the operational status of the local roadway network. LOS is a description of the quality of a roadway facility's operation, ranging from LOS A (indicating free-flow traffic conditions with little or no delay) to LOS F (representing oversaturated conditions where traffic flows exceed design capacity, resulting in long queues and delays). Intersections, rather than roadway segments between intersections, are almost always the capacity controlling locations for any circulation system.

Signalized Intersections. For signalized intersections, the *Year 2017 6th Edition Highway Capacity Manual* (Transportation Research Board, National Research Council) methodology was utilized. With this methodology, operations are defined by the level of service and average control delay per vehicle (measured in seconds) for the entire intersection. For a signalized intersection, control delay is the portion of the total delay attributed to traffic signal operation. This includes delay associated with deceleration, acceleration, stopping, and moving up in the queue. **Table 1** summarizes the relationship between delay and LOS for signalized intersections.

Unsignalized Intersections. For unsignalized (all-way stop-controlled and side-street stop-controlled) intersections, the *Year 2017 6th Edition Highway Capacity Manual* (Transportation Research Board, National Research Council) methodology for unsignalized intersections was utilized. For side-street stop-controlled intersections, operations are defined by the level of service and average control delay per vehicle (measured in seconds), with delay reported for the stop sign controlled approaches or turn movements. For all-way stop-controlled intersections, operations are defined by the average control delay for the entire intersection (measured in seconds per vehicle). The delay at an unsignalized

intersection incorporates delay associated with deceleration, acceleration, stopping, and moving up in the queue. **Table 2** summarizes the relationship between delay and LOS for unsignalized intersections while **Appendix B** presents level of service worksheets.

2. MINIMUM ACCEPTABLE OPERATION

Napa County's current minimum acceptable operating standard is level of service D (LOS D) for signalized or all-way stop overall intersection operation, as well as for side street stop sign controlled approaches at two-way stop unsignalized intersections.

E. ARTERIAL LEVEL OF SERVICE

1. ANALYSIS METHODOLOGY

The *2017 Highway Capacity Manual 6th Edition* arterial analysis methodology has been utilized for analysis of Silverado Trail north and south of Crystal Springs Road. Analysis results are presented as a level of service and demand capacity ratio. Input includes directional volumes, road and shoulder widths, percent trucks and RV's, terrain characteristics, percent available passing distance, etc.

2. MINIMUM ACCEPTABLE OPERATION

Napa County's current minimum acceptable operating standard for arterials is level of service D (LOS D).

F. INTERSECTION SIGNAL WARRANTS

1. ANALYSIS METHODOLOGY

Traffic signals are used to provide an orderly flow of traffic through an intersection. Many times, they are needed to offer side street traffic an opportunity to access a major road where high volumes and/or high vehicle speeds block crossing or turn movements. They do not, however, increase the capacity of an intersection (i.e., increase the overall intersection's ability to accommodate additional vehicles) and, in fact, often slightly reduce the number of total vehicles that can pass through an intersection in a given period of time. Signals can also cause an increase in traffic accidents if installed at inappropriate locations.

There are 10 possible tests for determining whether a traffic signal should be considered for installation. These tests, called "warrants", consider criteria such as actual traffic volume, pedestrian volume, presence of school children, and accident history. The intersection volume data together with the available collision histories were compared to warrants contained in the *California Manual on Uniform Traffic Control Devices, 2014, Rev 5 (2014 CaMUTCD Rev 5 - March 2020)*. It provides guidelines, or warrants, which may indicate need for a traffic signal at an unsignalized intersection. As indicated in the *2014 CaMUTCD Rev 5 - March 2020*, satisfaction of one or more warrants does not necessarily require immediate installation of a traffic signal. It is merely an indication that the local jurisdiction should begin monitoring conditions at that location and that a signal may ultimately be required.

2. MINIMUM ACCEPTABLE OPERATION

Warrant 3, the peak hour volume warrant, is often used as an initial check of signalization needs since peak hour volume data is typically available and this warrant is usually the first one to be met. Warrant 3 is based on a logarithmic curve and takes only the hour with the highest volume of the day into account. For intersections in rural locations (with local area population less than 10,000 people or where the posted speed limit or 85th percentile speed on the uncontrolled intersection approaches is greater than 40 miles per hour) a 70 % warrant is applied. The regular and 70 % warrants are typically referred to as the urban and rural peak hour warrants. Rural warrant criteria have been used for evaluation of the Silverado Trail/Deer Park Road intersection. Please see **Appendix C** for the signal warrant charts.

G. PLANNED IMPROVEMENTS

There are no planned and funded improvements at any location evaluated in this study (*Napa County Public Works Department, March 2021*).

H. ACCIDENT HISTORY

Accident records from January 2014 through 2019 were obtained from the California Highway Patrol for the entire length of Crystal Springs Road, Silverado Trail from Crystal Springs Road to Deer Park Road, Deer Park Road from Silverado Trail to Sanitarium Road and Sanitarium Road from Deer Park Road to Crystal Springs Road. Locations of all accidents over this time span are presented in **Figure 8**, while year by year accident details are presented in **Appendix D**. As shown, there were only two reported accidents along the entire length of Crystal Springs Road for the last 6 years: one just north of Sanitarium Road that was caused by unsafe speed, and one at the Silverado Trail/Crystal Springs Road intersection due to an improper turn. The Silverado Trail/Deer Park Road and Sanitarium Road/Deer Park Road intersections both experienced four accidents during the 6-year survey period.

I. EXISTING PEDESTRIAN AND BICYCLE FACILITIES NEAR THE PROJECT

There are no pedestrian walkways along the entire length of Crystal Springs Road, nor along Silverado Trail or Sanitarium Road in the project vicinity. Likewise, there are no Class 1 to 4 bicycle facilities along Crystal Springs Road, but Class II signed and striped bicycle lanes are provided along Silverado Trail. See **Figure 9**.

J. TRANSIT SERVICE

There is no transit service along Crystal Springs Road, Deer Park Road, Sanitarium Road or Silverado Trail. See **Figure 9**.

VI. FUTURE HORIZON TRAFFIC VOLUME PROJECTIONS

Traffic analysis has been conducted for harvest Existing (2019), Year 2025 and Cumulative (Year 2030) horizons at County request. The 2030 Cumulative horizon reflects the County General Plan Buildout year. Traffic modeling for the General Plan shows the following growths in two-way traffic between 2019 and 2030 for the following roadways:

<u>Route</u>	<u>2019 to 2030 Projected Growth in 2-Way PM Peak Hour Traffic (Rounded)</u>
Silverado Trail (just north of Deer Park Rd)	PM Peak Hour = 28.5%
Deer Park Road (east of Silverado Trail)	PM Peak Hour = 14.0%

Projecting straight line traffic growth for analysis purposes, this translates into the following growths in two-way traffic between 2019 and 2025 for the same roadways.

<u>Route</u>	<u>2019 to 2025 Projected Growth in 2-Way PM Peak Hour Traffic (Rounded)</u>
Silverado Trail (just north of Deer Park Rd)	PM Peak Hour = 15.5%
Deer Park Road (east of Silverado Trail)	PM Peak Hour = 7.7%

Traffic modeling projections were only available for weekday PM peak hour conditions and not for the Saturday PM peak hour. Therefore, Saturday two-way PM peak hour volumes were increased by the percentages found for the weekday PM peak hour. Also, since no traffic model projections were available for Crystal Springs Road, a 1% per year growth rate from 2019 has been utilized for evaluation purposes. Please note that the 2019 base includes traffic from many residences and other facilities just destroyed by fire in late 2020.

Based upon input from County Planning, Building & Environmental Services (PBES), there are no other approved but not constructed developments in the project vicinity that would add any significant traffic to Crystal Springs Road, North Fork Crystal Springs Road or Sanitarium Road.

Resultant Year 2025 harvest “Without Project” Friday and Saturday PM peak hour volumes are presented in **Figures 10** and **11**, while Cumulative (Year 2030) harvest “Without Project” Friday and Saturday PM peak hour volumes are presented in **Figures 12** and **13**.

VII. OFF-SITE HARVEST CIRCULATION SYSTEM OPERATION – WITHOUT PROJECT

A. YEAR 2019 HARVEST (WITHOUT PROJECT) OPERATING CONDITIONS

1. EXISTING INTERSECTION LEVEL OF SERVICE – SEE TABLE 3 & APPENDIX B FOR CAPACITY WORKSHEETS

a. SILVERADO TRAIL/DEER PARK ROAD

- **Friday & Saturday PM Peak Hours**
Unacceptable all-way stop operation (LOS F Friday & LOS E Saturday).

b. SILVERADO TRAIL/CRYSTAL SPRINGS ROAD

- **Friday & Saturday PM Peak Hours**
Acceptable Crystal Springs Road stop sign controlled westbound approach operation: LOS B or C.

c. SANITARIUM ROAD/DEER PARK ROAD

- **Friday & Saturday PM Peak Hours**
Acceptable Sanitarium Road stop and yield sign controlled southbound approach operation: LOS A or B.

d. SANITARIUM ROAD/CRYSTAL SPRINGS ROAD

- **Friday & Saturday PM Peak Hours**
Acceptable Crystal Springs Road stop sign controlled southbound approach operation: LOS A or B.

e. CRYSTAL SPRINGS ROAD/NORTH FORK CRYSTAL SPRINGS ROAD

- **Friday & Saturday PM Peak Hours**
Acceptable North Fork Crystal Springs Road yield controlled westbound approach operation: LOS A.

f. CRYSTAL SPRINGS ROAD/WINERY MAIN DRIVEWAY

- **Friday & Saturday PM Peak Hours**
Acceptable driveway eastbound approach operation: LOS A.

2. EXISTING ARTERIAL SEGMENT LEVEL OF SERVICE – SEE TABLE 4

a. SILVERADO TRAIL NORTH & SOUTH OF CRYSTAL SPRINGS ROAD

- **Friday PM Peak Hour**
Northbound - Acceptable LOS B
Southbound - Acceptable LOS B
- **Saturday PM Peak Hour**
Northbound - Acceptable LOS B
Southbound - Acceptable LOS B

3. EXISTING SIGNAL WARRANT EVALUATION – SEE TABLE 5 & APPENDIX C

a. SILVERADO TRAIL/DEER PARK ROAD INTERSECTION

- **Friday & Saturday PM Peak Hours**

Volumes exceed peak hour signal Warrant #3 rural criteria.

B. YEAR 2025 HARVEST (WITHOUT PROJECT) OPERATING CONDITIONS

1. 2025 INTERSECTION LEVEL OF SERVICE – SEE TABLE 3 & APPENDIX B FOR CAPACITY WORKSHEETS

a. SILVERADO TRAIL/DEER PARK ROAD

- **Friday & Saturday PM Peak Hours**

Unacceptable all-way stop operation (LOS F Friday & Saturday).

b. SILVERADO TRAIL/CRYSTAL SPRINGS ROAD

- **Friday & Saturday PM Peak Hours**

Acceptable Crystal Springs Road stop sign controlled westbound approach operation: LOS B or C.

c. SANITARIUM ROAD/DEER PARK ROAD

- **Friday & Saturday PM Peak Hours**

Acceptable Sanitarium Road stop sign controlled southbound approach operation: LOS A or B.

d. SANITARIUM ROAD/CRYSTAL SPRINGS ROAD

- **Friday & Saturday PM Peak Hours**

Acceptable Crystal Springs Road stop sign controlled southbound approach operation: LOS A or B.

e. CRYSTAL SPRINGS ROAD/NORTH FORK CRYSTAL SPRINGS ROAD

- **Friday & Saturday PM Peak Hours**

Acceptable North Fork Crystal Springs Road yield controlled westbound approach operation: LOS A.

f. CRYSTAL SPRINGS ROAD/WINERY MAIN DRIVEWAY

- **Friday & Saturday PM Peak Hours**

Acceptable driveway eastbound approach operation: LOS A.

2. 2025 ARTERIAL SEGMENT LEVEL OF SERVICE – SEE TABLE 4

a. SILVERADO TRAIL NORTH & SOUTH OF CRYSTAL SPRINGS ROAD

- **Friday PM Peak Hour**
Northbound - Acceptable LOS B or C
Southbound - Acceptable LOS B
- **Saturday PM Peak Hour**
Northbound - Acceptable LOS B
Southbound - Acceptable LOS B

3. 2025 SIGNAL WARRANT EVALUATION – SEE TABLE 5

a. SILVERADO TRAIL/DEER PARK ROAD INTERSECTION

- **Friday & Saturday PM Peak Hours**
Volumes will **exceed** peak hour signal Warrant #3 rural criteria.

C. CUMULATIVE (YEAR 2030) HARVEST (WITHOUT PROJECT) OPERATING CONDITIONS

1. 2030 INTERSECTION LEVEL OF SERVICE – SEE TABLE 3

a. SILVERADO TRAIL/DEER PARK ROAD

- **Friday & Saturday PM Peak Hours**
Unacceptable all-way stop operation (LOS F Friday & Saturday).

b. SILVERADO TRAIL/CRYSTAL SPRINGS ROAD

- **Friday & Saturday PM Peak Hours**
Acceptable Crystal Springs Road stop sign controlled westbound approach operation: LOS B or C.

c. SANITARIUM ROAD/DEER PARK ROAD

- **Friday & Saturday PM Peak Hours**
Acceptable Sanitarium Road stop sign controlled southbound approach operation: left turn LOS A or B.

d. SANITARIUM ROAD/CRYSTAL SPRINGS ROAD

- **Friday & Saturday PM Peak Hours**
Acceptable Crystal Springs Road stop sign controlled southbound approach operation: LOS A or B.

e. CRYSTAL SPRINGS ROAD/NORTH FORK CRYSTAL SPRINGS ROAD

- **Friday & Saturday PM Peak Hours**
Acceptable North Fork Crystal Springs Road yield controlled westbound approach operation: LOS A.

- f. **CRYSTAL SPRINGS ROAD/WINERY MAIN DRIVEWAY**
 - **Friday & Saturday PM Peak Hours**
Acceptable driveway eastbound approach operation: LOS A.

2. 2030 ARTERIAL SEGMENT LEVEL OF SERVICE – SEE TABLE 4

- a. **SILVERADO TRAIL NORTH & SOUTH OF CRYSTAL SPRINGS ROAD**
 - **Friday PM Peak Hour**
Northbound - Acceptable LOS C
Southbound - Acceptable LOS B or C
 - **Saturday PM Peak Hour**
Northbound - Acceptable LOS B or C
Southbound - Acceptable LOS B

3. 2030 SIGNAL WARRANT EVALUATION – SEE TABLE 5

- a. **SILVERADO TRAIL/DEER PARK ROAD INTERSECTION**
 - **Friday & Saturday PM Peak Hours**
Volumes will **exceed** peak hour signal Warrant #3 rural criteria.

VIII. SIGNIFICANCE CRITERIA

A. COUNTY OF NAPA

The following criteria have recently been developed for traffic impact analyses in Napa County.

EXISTING + PROJECT CONDITIONS

1. ARTERIAL SEGMENTS

A project would cause a significant impact requiring mitigation if:

- a. An arterial segment operates at LOS A, B, C or D during the selected peak hours without project trips, and deteriorates to LOS E or F with the addition of project trips, or
- b. An arterial segment operates at LOS E or F during the selected peak hours without project trips, and the addition of project trips increases the total segment volume by one percent or more.

For the second criteria, the following equation should be used if the arterial operates at LOS E or F without the project:

$$\text{Project Contribution \%} = \text{Project Trips} \div \text{Existing Volumes}$$

2. SIGNALIZED INTERSECTIONS

A project would cause a significant impact requiring mitigation if:

- a. A signalized intersection operates at LOS A, B, C or D during the selected peak hours without project trips, and deteriorates to LOS E or F with the addition of project trips, or
- b. A signalized intersection operates at LOS E or F during the selected peak hours without project trips, and the addition of project trips increases the total entering volume by one percent or more.

For the second criteria, the following equation should be used if the signalized intersection operates at LOS E or F without the project:

$$\text{Project Contribution \%} = \text{Project Trips} \div \text{Existing Volumes}$$

Maintaining LOS D or better at all signalized intersections would sometimes require expanding the physical footprint of an intersection. In some locations around the County, expanding physical transportation infrastructure could be in direct conflict with the County's goals of preserving the area's rural character, improving safety, and sustaining the agricultural industry, making these potential improvements infeasible. The County's Circulation Element lists intersections that are slated for improvement or expansion in unincorporated Napa County. *(According to the Circulation Element dated June 8, 2008, the following intersections can be altered or expanded as a mitigation measure: SR-12/Airport Boulevard/SR-29, SR-221/SR-12/Highway 29, and several intersections along SR-29 and SR-128 north of Napa. The significance criteria shown above should apply to facilities where appropriate based upon the most recent Circulation Element chapter of the General Plan.)*

Transportation studies should individually consider the feasibility of potential mitigation measures with respect to right-of-way acquisition, regardless of the intersection's place in the Circulation Element's identified improvement lists, and present potential alternative mitigation measures that do not require right-of-way acquisition. County staff would then review that information and make the decision about the feasibility of the identified potential mitigations. For the intersections that cannot be improved without substantial additional right-of-way according to both the Circulation Element and the individual transportation impact study, and where other mitigations such as updating signal timing, signal phasing and operations, and/or signing and striping improvements do not improve the LOS, LOS E or LOS F will be considered acceptable and the one percent threshold would not apply. Analysis of signalized intersection LOS should still be presented for informational purposes, and there should still be an evaluation of effects on safety and local access, per *Policy CIR-18*.

3. UNSIGNALIZED INTERSECTIONS (ALL WAY STOP AND SIDE STREET STOP SIGN CONTROLLED)

LOS for all way stop controlled intersections is defined as an average of the delay at all approaches. LOS for side street stop-controlled intersections is defined by the delay and LOS for the worst-case approach. The recommended interpretation of *Policy CIR-16* regarding unsignalized intersection significance criteria is as follows:

- a. An unsignalized intersection operates at LOS A, B, C or D during the selected peak hours without project trips, the LOS deteriorates to LOS E or F with the addition of project traffic, and the peak hour traffic signal warrant criteria should also be evaluated and presented for informational purposes, or
- b. An unsignalized intersection operates at LOS E or F during the selected peak hours without project trips, and the project increases stop sign controlled delay by 5 seconds or greater. The peak hour traffic signal warrant criteria should also be evaluated and presented for informational purposes.

$$\text{Project Contribution \%} = \text{Project Trips} \div \text{Existing Volumes}$$

CUMULATIVE + PROJECT CONDITIONS

1. ARTERIAL SEGMENTS, SIGNALIZED INTERSECTIONS AND UNSIGNALIZED INTERSECTIONS

A project would cause a significant Cumulative impact requiring mitigation if:

- a. The overall amount of expected traffic growth causes conditions to deteriorate such that any of the significance criteria described above for Existing conditions are met, and
- b. The project's contribution to a significant Cumulative impact for arterials or signalized intersections would be equal to or greater than five percent of the growth in traffic from Existing to Cumulative conditions.
- c. The project's contribution to a Cumulative significant impact at an unsignalized intersection would result with an increase in stop sign controlled delay of 5 seconds or greater.

A project's contribution to a Cumulative condition would be calculated as the project's percentage contribution to the total growth in traffic from Existing conditions.

$$\text{Project Contribution \%} = \text{Project Trips} \div (\text{Cumulative Volumes} - \text{Existing Volumes})$$

IX. PROJECT IMPACT EVALUATION

A. TRIP GENERATION

1. METHODOLOGY

Project trip generation was determined using Methodology (C) from the three possible analysis procedures approved by Napa County Public Works for transportation impact study analysis (for Winery use permits). Methodology C allows analysis using actual trip counts at driveways of wineries with comparable operating characteristics to that of the proposed winery - in this case Vida Valiente Winery. Three recent studies of comparable facilities provided Friday and Saturday two-way hourly volumes and percent of daily volumes. The list of wineries and harvest weekday characteristics is as follows.

- Dakota Shy Winery:** 2 full time and 2 part time employees + 20 visitors/day
- Wheeler Farms Winery:** 14 full time and 8 part time employees + 32 visitors/day
- Materra Winery:** 3 full time and 7 part time employees + 18 visitors/day

In comparison to

- Vida Valiente Winery:** 5 full time and 4 part time employees + 28 visitors/day

Appendix E contains the 2018 or 2019 harvest Friday and Saturday hourly percent traffic now occurring at the Dakota Shy, Wheeler Farms and Materra Wineries. Twenty-four-hour counts were conducted on two Fridays and two Saturdays at each facility. The highest hourly traffic percentage from the three surveyed facilities was used for projecting Vida Valiente Friday and Saturday PM peak hour volumes. Using this methodology 21% of Vida Valiente daily traffic was expected to occur during the Friday PM peak hour, while 19% of Vida Valiente daily traffic was projected to occur during the Saturday PM peak hour.

The increment of net new daily traffic due to the Vida Valiente proposed Winery was first determined using trip rates from the Use Permit Winery Traffic Information/Trip Generation sheets. The highest hourly percentages from the three Winery surveys were then applied to the Winery’s Friday and Saturday daily traffic to determine the amount of project traffic that would be expected to occur during the Winery’s PM peak traffic hours. Finally, it was assumed that the Winery’s PM peak hourly traffic on a Friday and Saturday would occur at the same time as the ambient peak traffic time on the adjacent roadway system.

2. PROJECT PM PEAK HOUR VOLUMES

Table 6 shows that the proposed use permit would be expected to generate 7 new inbound and 7 new outbound trips during a harvest Friday PM peak hour on the local roadway system (3:15 - 4:15), with 5 new inbound and 5 new outbound trips during a harvest Saturday PM peak hour on the local roadway system (2:45 - 3:45). Winery Traffic Information/Trip Generation sheets are presented in **Appendix E**.

B. TRIP DISTRIBUTION

Project traffic was distributed to Crystal Springs Road, Silverado Trail, Sanitarium Road and Deer Park Road in a pattern reflective of Existing PM peak hour distribution patterns at local intersections and the Winery’s commitment to direct as much project traffic to Crystal Springs Road north of the site as possible. During the September 2018 counts there were two wineries open along the North Fork Crystal Springs Road.

	PERCENT PROJECT TRIP DISTRIBUTION IMMEDIATE SITE VICINITY	
	<u>Friday PM Peak Hour</u>	<u>Saturday PM Peak Hour</u>
Crystal Springs Road north of Winery	85%	85%
Crystal Springs Road south of Winery	15%	15%

While it is the desire that all project traffic use Crystal Springs Road north of the project for all in- and outbound access, the reality is that those drivers depending upon navigation systems may be directed to use Crystal Springs Road south of the site if they are traveling to or from the south.

	PERCENT PROJECT TRIP DISTRIBUTION SUBREGION	
	<u>Friday PM Peak Hour</u>	<u>Saturday PM Peak Hour</u>
Silverado Trail north	33%	33%
Silverado Trail south	34%	34%
Deer Park Road west	33%	33%

The harvest Friday and Saturday project traffic increments expected during the times of ambient PM peak traffic flows are presented in **Figures 14** and **15**. Friday and Saturday “With Project” PM peak hour harvest volumes for Year 2019 are presented in **Figures 16** and **17**; “With Project” PM peak hour harvest volumes for Year 2025 conditions are presented in **Figures 18** and **19**, and “With Project” PM peak hour harvest volumes for Cumulative (Year 2030) conditions are presented in **Figures 20** and **21**.

C. OFF-SITE IMPACTS

1. EXISTING (2019) HARVEST + PROJECT CONDITIONS

a. SUMMARY

Project traffic would not result in any significant level of service impacts along Silverado Trail, at the Silverado Trail intersections with Crystal Springs Road or Deer Park Road, the Sanitarium Road intersections with Deer Park Road or Crystal Springs Road, nor at the Crystal Springs Road intersections with the North Fork Crystal Springs Road or the Winery Driveway during either the Friday or Saturday PM peak traffic hours. ***Less than significant.***

b. 2019 INTERSECTION LEVEL OF SERVICE IMPACTS – SEE TABLE 3

1) Silverado Trail/Deer Park Road

• **Friday & Saturday PM Peak Hours**

All-way stop operation would remain an **unacceptable** LOS F during the Friday PM peak hour and an **unacceptable** LOS E during the Saturday PM peak hour with the addition of project traffic. However, delay would be increased by less than the 5-second or greater, the County significance criteria limit on both days (1.6 seconds during the Friday PM peak hour and 0.7 seconds during the Saturday PM peak hour). ***Less than significant.***

2) Silverado Trail/Crystal Springs Road

• **Friday & Saturday PM Peak Hours**

Operation of the stop sign controlled Crystal Springs Road intersection approach would remain an acceptable LOS C on Friday and an acceptable LOS B on Saturday with the addition of project traffic. ***Less than significant.***

3) Sanitarium Road/Deer Park Road

• **Friday & Saturday PM Peak Hours**

Operation of the stop sign and yield controlled Sanitarium Road intersection approach would remain an acceptable LOS B on Friday and an acceptable LOS A on Saturday with the addition of project traffic. ***Less than significant.***

4) Sanitarium Road/Crystal Springs Road

• **Friday & Saturday PM Peak Hours**

Operation of the stop sign controlled Crystal Springs Road intersection approach would remain an acceptable LOS B on Friday and an acceptable LOS A on Saturday with the addition of project traffic. ***Less than significant.***

5) Crystal Springs Road/North Fork Crystal Springs Road

• **Friday & Saturday PM Peak Hours**

Operation of the yield controlled North Fork Crystal Springs Road intersection approach would be an acceptable LOS A during both the Friday and Saturday PM peak hours with the addition of project traffic. ***Less than significant.***

6) Crystal Springs Road/Winery Main Driveway

• **Friday & Saturday PM Peak Hours**

Operation of the Winery Main Driveway approach to Crystal Springs Road would be an acceptable LOS A during both the Friday and Saturday PM peak hours with the addition of project traffic. ***Less than significant.***

c. **2019 ARTERIAL SEGMENT LEVEL OF SERVICE IMPACTS – SEE TABLE 4**

1) **Silverado Trail North & South of Crystal Springs Road**

• **Friday PM Peak Hour**

Operation would remain an acceptable LOS B northbound and an acceptable LOS B southbound with the addition of project traffic. *Less than significant.*

• **Saturday PM Peak Hour**

Operation would remain an acceptable LOS B northbound and an acceptable LOS B southbound with the addition of project traffic. *Less than significant.*

d. **2019 SIGNAL WARRANT EVALUATION – SEE TABLE 5**

Signal warrant information is provided for informational purposes only per County significance criteria.

1) **Silverado Trail/Deer Park Road**

• **Friday & Saturday PM Peak Hours**

Volumes would be **exceeding** peak hour signal Warrant #3 rural criteria with or without project traffic.

2. **YEAR 2025 HARVEST + PROJECT CONDITIONS**

a. **SUMMARY**

Project traffic would not result in any significant level of service impacts along Silverado Trail, at the Silverado Trail intersections with Crystal Springs Road or Deer Park Road, the Sanitarium Road intersections with Deer Park Road or Crystal Springs Road, nor at the Crystal Springs Road intersections with the North Fork Crystal Springs Road or the Winery Driveway during either the Friday or Saturday PM peak traffic hours. *Less than significant.*

b. **2025 INTERSECTION LEVEL OF SERVICE IMPACTS – SEE TABLE 3**

1) **Silverado Trail/Deer Park Road**

• **Friday & Saturday PM Peak Hours**

All-way stop operation would remain an **unacceptable** LOS F during the Friday PM peak hour and an **unacceptable** LOS F during the Saturday PM peak hour with the addition of project traffic. However, delay would be increased by less than the 5-second or greater, the County significance criteria limit on both days (1.0 second during both the Friday and Saturday PM peak hours). *Less than significant.*

2) Silverado Trail/Crystal Springs Road

• **Friday & Saturday PM Peak Hours**

Operation of the stop sign controlled Crystal Springs Road intersection approach would remain an acceptable LOS C on Friday and an acceptable LOS B on Saturday with the addition of project traffic. *Less than significant.*

3) Sanitarium Road/Deer Park Road

• **Friday & Saturday PM Peak Hours**

Operation of the stop sign and yield controlled Sanitarium Road approach would remain an acceptable LOS B on Friday and an acceptable LOS A on Saturday with the addition of project traffic. *Less than significant.*

4) Sanitarium Road/Crystal Springs Road

• **Friday & Saturday PM Peak Hours**

Operation of the stop sign controlled Crystal Springs Road intersection approach would remain an acceptable LOS B on Friday and an acceptable LOS A on Saturday with the addition of project traffic. *Less than significant.*

5) Crystal Springs Road/North Fork Crystal Springs Road

• **Friday & Saturday PM Peak Hours**

Operation of the yield controlled North Fork Crystal Springs Road intersection approach would be an acceptable LOS A during both the Friday and Saturday PM peak hours with the addition of project traffic. *Less than significant.*

6) Crystal Springs Road/Winery Main Driveway

• **Friday & Saturday PM Peak Hours**

Operation of the Winery Main Driveway approach to Crystal Springs Road would be an acceptable LOS A during both the Friday and Saturday PM peak hours with the addition of project traffic. *Less than significant.*

c. 2025 ARTERIAL SEGMENT LEVEL OF SERVICE IMPACTS – SEE TABLE 4

1) Silverado Trail North & South of Crystal Springs Road

• **Friday PM Peak Hour**

Operation would remain an acceptable LOS B or C northbound and an acceptable LOS B southbound with the addition of project traffic. *Less than significant.*

• **Saturday PM Peak Hour**

Operation would remain an acceptable LOS B northbound and an acceptable LOS B southbound with the addition of project traffic. *Less than significant.*

d. 2025 SIGNAL WARRANT EVALUATION – SEE TABLE 5

Signal warrant information is provided for informational purposes only per County significance criteria.

1) Silverado Trail/Deer Park Road

• **Friday & Saturday PM Peak Hours**

Volumes would be **exceeding** peak hour signal Warrant #3 rural criteria with or without project traffic.

3. CUMULATIVE (YEAR 2030) HARVEST + PROJECT CONDITIONS

a. SUMMARY

Project traffic would not result in any significant level of service impacts along Silverado Trail, at the Silverado Trail intersections with Crystal Springs Road or Deer Park Road, the Sanitarium Road intersections with Deer Park Road or Crystal Springs Road, nor at the Crystal Springs Road intersections with the North Fork Crystal Springs Road or the Winery Driveway during either the Friday or Saturday PM peak traffic hours. ***Less than significant.***

b. 2030 INTERSECTION LEVEL OF SERVICE IMPACTS – SEE TABLE 3

1) Silverado Trail/Deer Park Road

• **Friday & Saturday PM Peak Hours**

All-way stop operation would remain an **unacceptable** LOS F during the Friday PM peak hour and an **unacceptable** LOS F during the Saturday PM peak hour with the addition of project traffic. However, delay would be increased by less than the 5-second or greater, the County significance criteria limit on both days (1.4 seconds during the Friday PM peak hour and 1.1 seconds during the Saturday PM peak hour). ***Less than significant.***

2) Silverado Trail/Crystal Springs Road

• **Friday & Saturday PM Peak Hours**

Operation of the stop sign controlled Crystal Springs Road intersection approach would remain an acceptable LOS C on Friday and an acceptable LOS B on Saturday with the addition of project traffic. ***Less than significant.***

3) Sanitarium Road/Deer Park Road

• **Friday & Saturday PM Peak Hours**

Operation of the stop sign and yield controlled Sanitarium Road left turn intersection approach would remain an acceptable LOS B on Friday and an acceptable LOS A on Saturday with the addition of project traffic. ***Less than significant.***

4) Sanitarium Road/Crystal Springs Road

• **Friday & Saturday PM Peak Hours**

Operation of the stop sign controlled Crystal Springs Road intersection approach would remain an acceptable LOS B on Friday and an acceptable LOS A on Saturday with the addition of project traffic. ***Less than significant.***

5) Crystal Springs Road/North Fork Crystal Springs Road

• **Friday & Saturday PM Peak Hours**

Operation of the yield controlled North Fork Crystal Springs Road intersection approach would be an acceptable LOS A during both the Friday and Saturday PM peak hours with the addition of project traffic. ***Less than significant.***

6) Crystal Springs Road/Winery Main Driveway

• **Friday & Saturday PM Peak Hours**

Operation of the Winery Main Driveway approach to Crystal Springs Road would be an acceptable LOS A during both the Friday and Saturday PM peak hours with the addition of project traffic. ***Less than significant.***

c. 2030 ARTERIAL SEGMENT LEVEL OF SERVICE IMPACTS – SEE TABLE 4

1) Silverado Trail North & South of Crystal Springs Road

• **Friday PM Peak Hour**

Operation would remain an acceptable LOS C northbound and an acceptable LOS B or C southbound with the addition of project traffic. ***Less than significant.***

• **Saturday PM Peak Hour**

Operation would remain an acceptable LOS B or C northbound and an acceptable LOS B southbound with the addition of project traffic. ***Less than significant.***

d. 2030 SIGNAL WARRANT EVALUATION – SEE TABLE 5

Signal warrant information is provided for informational purposes only per County significance criteria.

1) Silverado Trail/Deer Park Road

• **Friday & Saturday PM Peak Hours**

Volumes would be **exceeding** peak hour signal Warrant #3 rural criteria with or without project traffic.

X. OTHER POTENTIAL PROJECT IMPACTS

A. WINERY DRIVEWAY SIGHT LINES AT CRYSTAL SPRINGS ROAD

Two Winery Driveway connections will be provided to Crystal Springs Road, one near the middle and one near the south end of the project frontage (see **Figure 3**). The North (Main) Driveway will provide two-way traffic flow while the South Driveway will only provide outbound flow for trucks.

1. SIGHT LINES AT CRYSTAL SPRINGS ROAD/WINERY NORTH DRIVEWAY

Sight lines at the Crystal Springs Road/Winery North Driveway intersection are currently acceptable to the north and south along Crystal Springs Road.

- Sight line to the south along Crystal Springs Road (to see northbound vehicles) - about 410 feet
- Sight line to the north along Crystal Springs Road (to see southbound vehicles) - about 380 feet

The *Caltrans Highway Design Manual (July 2020)* states that stopping sight distance is the corner sight distance criteria to be utilized at private road connections to arterial roadways. The minimum required stopping sight distances based upon various vehicle speeds are as follows:

SPEED	MINIMUM REQUIRED STOPPING SIGHT DISTANCE
25 mph	150 feet
30 mph	200 feet
35 mph	250 feet

The posted speed limit at the project entrance is 25 miles per hour, and a few vehicles were observed traveling higher than the posted limit during two field surveys by Crane Transportation Group. The road in close proximity to the north entrance is 24 feet wide, level and straight. Based upon a 35 mile per hour criteria, resultant sight lines to the north and south along Crystal Springs Road from the Winery North Driveway are acceptable. ***Less than significant.***

2. SIGHT LINES AT CRYSTAL SPRINGS ROAD/WINERY SOUTH DRIVEWAY

Sight lines at the Crystal Springs Road/Winery South Driveway intersection are currently acceptable to the north and south along Crystal Springs Road.

- Sight line to the south along Crystal Springs Road (to see northbound vehicles) - about 250 feet
- Sight line to the north along Crystal Springs Road (to see southbound vehicles) - about 350 feet

The *Caltrans Highway Design Manual (July 2020)* states that stopping sight distance is the corner sight distance criteria to be utilized at private road connections to arterial roadways. The minimum required stopping sight distances based upon various vehicle speeds are as follows:

SPEED	MINIMUM REQUIRED STOPPING SIGHT DISTANCE FOR SOUTHBOUND TRAFFIC	MINIMUM REQUIRED STOPPING SIGHT DISTANCE FOR NORTHBOUND TRAFFIC
25 mph	150 feet	150 feet
30 mph	200 feet	200 feet
35 mph	250 feet	N/A

Crystal Springs Road has an intersection with the entrance to the St. Helena water treatment plant about 90 feet south of the proposed Winery South Driveway connection. This requires northbound vehicles on Crystal Springs Road to make a sharp 30 degree turn to the left in order to continue on Crystal Springs Road. Immediately after turning, Crystal Springs Road crosses about a 45-foot-long and 25-foot-wide bridge with railings located adjacent to the pavement. This slows northbound traffic flow down to 25-30 miles per hour as it approaches the South Driveway connection. However, even based upon a 35 mile per hour criteria for north or southbound traffic, resultant sight lines to the north and south along Crystal Springs Road from the Winery’s South Driveway are acceptable. ***Less than significant.***

B. LEFT-TURN LANE AT CRYSTAL SPRINGS ROAD/WINERY MAIN DRIVEWAY INTERSECTION

A left-turn lane will not be warranted on the northbound Crystal Springs Road approach to the Winery North (Main) Driveway. Daily two-way volumes will be well below County Criteria, with only about 64 vehicles on the Winery North Driveway and about 280 cumulative weekday vehicles on Crystal Springs Road. The County left-turn lane warrant chart is provided in **Appendix F. *Less than significant.***

C. MARKETING EVENTS

A total of 28 marketing events are proposed as follows:

- 2 per month with 24 guests
- 3 per year with 60 guests
- 1 per year with 125 guests

In addition, for the twice per month events with 24 guests daily visitation by appointment will be reduced by the level of attendance at the marketing event. ***Less than significant.***

D. PEDESTRIAN, BICYCLE AND TRANSIT IMPACTS

There are no pedestrian walkways along Crystal Springs Road, Silverado Trail, Deer Park Road or Sanitarium Road in the project area. No pedestrian traffic is expected and no pedestrian facilities are

proposed along the project's Crystal Springs Road frontage. Bicycle racks will be provided for all guests using bicycles and accessing the area via the Class II bicycle lanes along Silverado Trail and Deer Park Road west of Silverado Trail. It should be noted, however that there are minimal to no shoulders along Crystal Springs Road between Silverado Trail or Sanitarium Road and the Project site. In general Crystal Springs Road would not be attractive to bicycle riders due to its width, but may be attractive due to its low volumes. Since there is no County transit service along Crystal Springs Road, Silverado Trail or Sanitarium Road, no employees or guests would be using transit. ***Less than significant.***

E. TRANSPORTATION DEMAND MANAGEMENT (TDM) PLAN & VEHICLE MILES TRAVELED (VMT) REDUCTIONS

It is a requirement of all jurisdictions in the state to reduce the Vehicle Miles Traveled (VMT) of traffic associated with new developments to lower levels than would have resulted with comparable projects in the past (per State Senate Bill 743, which took effect in July 2020). This will help reduce greenhouse gas emissions and vehicle congestion. Specific quantitative reduction guidelines have not yet been set for wineries in Napa County, but all are expected to develop ongoing programs that will provide incentives to reduce daily and commute period employee traffic as well as measures that will entice guests to use travel modes other than the automobile or to travel at times other than peak congestion periods. Towards this end, the Vida Valiente Winery will develop a Transportation Demand Management (TDM) plan that will help accomplish these goals.

The applicant will be appointing a TDM coordinator to carry out the proposed plan. See **Appendix G**. Measures will include providing incentives to establish carpools and riding bicycles to work. Bike racks will be provided for employees and guests. In addition, shuttle buses will be provided for all large events with 60 or more guests. ***Less than significant.***

F. ON-SITE PARKING & INTERNAL CIRCULATION

There will be a total of 11 on-site parking spaces with the proposed project (with one designated for ADA drivers). Visitors to the Winery will be by appointment only. On a busy day, the 28 visitors (in 10 to 11 daily vehicles) will arrive in a staggered arrangement so that there should never be more than 3 to 4 guest vehicles at the site at anytime. Occasionally, visitors will arrive in a higher-occupancy vehicle such as an SUV, minivan or smaller shuttle bus. The 4 to 9 employees per day would then occupy the remaining spaces.

When larger marketing events are held excess parking will be accommodated along the Winery access road and along vineyard roads. The Winery will utilize valet parking for these events in addition to the services of small shuttle buses or vans for some groups of visitors. Shuttle buses will bring visitors from their hotels or other areas where there are legally entitled parking areas. Internal circulation design (roadway & parking dimensions/parking spaces, turnaround areas and radii for emergency vehicle and large truck movements) will meet all County and CAL FIRE design criteria. ***Less than significant.***

G. YEARLY TRIP GENERATION

Based upon County formula the existing site uses are currently generating 0 yearly trips, while with the Winery trip generation would be 14,648. See **Appendix E**.

H. WIDTH OF CRYSTAL SPRINGS ROAD

Crystal Springs Road ranges in width from about 16 to 24 feet north of the Winery, and from about 12 to 18 feet south of the Winery. However, in order to minimize project traffic along the narrower sections of Crystal Springs Road (which are mostly south of the Winery) all promotional information and driving directions provided to guests will only show the Crystal Springs Road connection to Silverado Trail north of the site as the project access route. Also, a sign with the Winery's name will be provided on Silverado Trail at the Crystal Springs Road intersection. Finally, signs will be provided along both Winery Driveways for outbound drivers with an arrow pointing north and a message indicating to make a left turn to for access to Silverado Trail. *Informational purposes only.*

XI. RECOMMENDED IMPROVEMENTS

No off-site circulation system improvements are required at analyzed intersections or along Silverado Trail.

In order to minimize project traffic along the narrower sections of Crystal Springs Road (which are mostly south of the Winery) all promotional information and driving directions provided to guests should show only the Crystal Springs Road connection to Silverado Trail north of the site as the project access route. Also, a sign with the Winery's name will be provided on Silverado Trail at the Crystal Springs Road intersection. Finally, signs will be provided along Winery Driveways for outbound drivers with an arrow pointing north and a message indicating to make a left turn for access to Silverado Trail.

XII. CONCLUSIONS & RECOMMENDATIONS

- The project will result in no significant off-site circulation system operational impacts to Silverado Trail or to the Silverado Trail intersections with Deer Park Road and Crystal Springs Road, the Sanitarium Road intersections with Deer Park Road and Crystal Springs Road, and the Crystal Springs Road intersections with North Fork Crystal Springs Road and the Winery Driveways.
- A left-turn lane is not warranted on the northbound Crystal Springs Road approach to the Project Driveway.
- Sight lines at the Winery North and South Driveway connections to Crystal Springs Road are acceptable in both directions and meet Caltrans stopping sight distance criteria.

- No pedestrians nor transit users are expected at the Winery. However, bicycle racks will be provided for any bike riders accessing the Winery area via the Class II bike lanes along Silverado Trail or Deer Park Road west of Silverado Trail.
- Internal circulation will be designed to meet County and CAL FIRE criteria. In addition, 11 parking spaces will be provided for guests and employees.
- A total of 28 marketing events are being proposed, and on days with medium size (24 guest) marketing events which will occur 2 times per month), daily visitation by appointment will be reduced by the same amount as the number of guests at the marketing event.
- A TDM coordinator will be appointed to institute measures to reduce daily and peak hour employee traffic as well as increase limousine and shuttle bus service for large marketing events. The attached TDM Plan will be adopted.
- Crystal Springs Road ranges in width from about 16 to 24 feet north of the Winery, and from about 12 to 18 feet south of the Winery. However, in order to minimize project traffic along the narrower sections of Crystal Springs Road (which are mostly south of the Winery) all promotional information and driving directions provided to guests will only show the Crystal Springs Road connection to Silverado Trail north of the site as the project access route. Also, a sign with the Winery's name will be provided on Silverado Trail at the Crystal Springs Road intersection. Finally, signs will be provided along both Winery Driveways for outbound drivers with an arrow pointing north and a message indicating to make a left turn to for access to Silverado Trail.

This Report is intended for presentation and use in its entirety, together with all of its supporting exhibits, schedules, and appendices. Crane Transportation Group will have no liability for any use of the Report other than in its entirety, such as providing an excerpt to a third party or quoting a portion of the Report. If you provide a portion of the Report to a third party, you agree to hold CTG harmless against any liability to such third parties based upon their use of or reliance upon a less than complete version of the Report.

TABLES

TABLE 1**SIGNALIZED INTERSECTION LOS CRITERIA**

Level of Service	Description	Average Control Delay (Seconds Per Vehicle)
A	Operations with very low delay occurring with favorable progression and/or short cycle lengths.	≤ 10.0
B	Operations with low delay occurring with good progression and/or short cycle lengths.	10.0 to 20.0
C	Operations with average delays resulting from fair progression and/or longer cycle lengths. Individual cycle failures begin to appear.	20.0 to 35.0
D	Operations with longer delays due to a combination of unfavorable progression, long cycle lengths, and/or high volume-to-capacity (V/C) ratios. Many vehicles stop and individual cycle failures are noticeable.	35.0 to 55.0
E	Operations with high delay values indicating poor progression, long cycle lengths, and high V/C ratios. Individual cycle failures are frequent occurrences. This is considered to be the limit of acceptable delay.	55.0 to 80.0
F	Operation with delays unacceptable to most drivers occurring due to oversaturation, poor progression, or very long cycle lengths.	> 80.0

Source: Year 2017 6th Edition Highway Capacity Manual (Transportation Research Board).

TABLE 2**UNSIGNALIZED INTERSECTION LOS CRITERIA**

Level of Service	Description	Average Control Delay (Seconds Per Vehicle)
A	Little or no delays	≤ 10.0
B	Short traffic delays	10.0 to 15.0
C	Average traffic delays	15.0 to 25.0
D	Long traffic delays	25.0 to 35.0
E	Very long traffic delays	35.0 to 50.0
F	Extreme traffic delays with intersection capacity exceeded (for an all-way stop), or with approach/turn movement capacity exceeded (for a side street stop controlled intersection)	> 50.0

Source: Year 2017 6th Edition Highway Capacity Manual (Transportation Research Board)

TABLE 3

INTERSECTION LEVEL OF SERVICE

YEAR 2019 HARVEST

LOCATION	FRIDAY PM PEAK HOUR		SATURDAY PM PEAK HOUR	
	W/O PROJECT	WITH PROJECT	W/O PROJECT	WITH PROJECT
Silverado Trail/ Deer Park Road	F-76.7 ⁽¹⁾	F-78.3	E-46.2	E-46.9
Silverado Trail/ Crystal Springs Road	C-15.3 ⁽²⁾	C-15.6	B-12.9	B-13.1
Sanitarium Road/ Deer Park Road	B-10.6 ⁽³⁾	B-10.7	A-9.5	A-9.5
Sanitarium Road/ Crystal Springs Road	B-10.1 ⁽⁴⁾	B-10.1	A-9.4	A-9.4
Crystal Springs Road/ North Fork Crystal Springs Road	A-8.5 ⁽⁵⁾	A-8.5	A-8.4	A-8.4
Crystal Springs Road/ Project Driveway	N/A ⁽⁶⁾	A-8.6	N/A	A-8.6

YEAR 2025 HARVEST

LOCATION	FRIDAY PM PEAK HOUR		SATURDAY PM PEAK HOUR	
	W/O PROJECT	WITH PROJECT	W/O PROJECT	WITH PROJECT
Silverado Trail/ Deer Park Road	F-110.2 ⁽¹⁾	F-111.2	F-72.3	F-73.3
Silverado Trail/ Crystal Springs Road	C-15.5 ⁽²⁾	C-15.8	B-13.6	B-13.8
Sanitarium Road/ Deer Park Road	B-11.0 ⁽³⁾	B-11.0	A-9.7	A-9.7
Sanitarium Road/ Crystal Springs Road	B-10.3 ⁽⁴⁾	B-10.3	A-9.4	A-9.4
Crystal Springs Road/ North Fork Crystal Springs Road	A-8.5 ⁽⁵⁾	A-8.5	A-8.4	A-8.4
Crystal Springs Road/ Project Driveway	N/A ⁽⁶⁾	A-8.6	N/A	A-8.6

TABLE 3

INTERSECTION LEVEL OF SERVICE

CUMULATIVE (YEAR 2030) HARVEST

LOCATION	FRIDAY PM PEAK HOUR		SATURDAY PM PEAK HOUR	
	W/O PROJECT	WITH PROJECT	W/O PROJECT	WITH PROJECT
Silverado Trail/ Deer Park Road	F-144.9 ⁽¹⁾	F-146.3	F-107.0	F-108.1
Silverado Trail/ Crystal Springs Road	C-17.0 ⁽²⁾	C-17.5	B-14.6	B-14.9
Sanitarium Road/ Deer Park Road	B-11.3 ⁽³⁾	B-11.3	A-9.8	A-9.8
Sanitarium Road/ Crystal Springs Road	B-10.5 ⁽⁴⁾	B-10.5	A-9.5	A-9.5
Crystal Springs Road/ North Fork Crystal Springs Road	A-8.5 ⁽⁵⁾	A-8.5	A-8.4	A-8.4
Crystal Springs Road/ Project Driveway	N/A ⁽⁶⁾	A-8.7	N/A	A-8.6

⁽¹⁾All-Way-Stop – control delay in seconds: Silverado Trail at Deer Park Road

⁽²⁾Unsignalized level of service – control delay in seconds: Crystal Springs Rd Westbound approach to Silverado Trail

⁽³⁾Unsignalized level of service – control delay in seconds: Eastbound Sanitarium Rd approach to Deer Park Rd

⁽⁴⁾Unsignalized level of service – control delay in seconds: Eastbound Crystal Springs Rd approach to Sanitarium Rd

⁽⁵⁾Unsignalized level of service – control delay in seconds: North Fork Crystal Springs Rd Westbound approach to Crystal Springs Rd

⁽⁶⁾Unsignalized level of service – control delay in seconds: Northbound Project Driveway approach to Crystal Springs Rd
6th Edition Highway Capacity Manual (HCM) Analysis Methodology for unsignalized intersections (2017)

Source: Crane Transportation Group

TABLE 4

ARTERIAL LEVEL OF SERVICE

YEAR 2019 HARVEST

LOCATION	FRIDAY PM PEAK HOUR				SATURDAY PM PEAK HOUR			
	W/O PROJECT		WITH PROJECT		W/O PROJECT		WITH PROJECT	
	NB	SB	NB	SB	NB	SB	NB	SB
Silverado Trail North of Crystal Springs Road	B-.25 ⁽¹⁾	B-.22	B-.25	B-.23	B-.23	B-.18	B-.23	B-.18
Silverado Trail South of Crystal Springs Road	B-.25 ⁽¹⁾	B-.24	B-.26	B-.25	B-.23	B-.20	B-.23	B-.20

YEAR 2025 HARVEST

LOCATION	FRIDAY PM PEAK HOUR				SATURDAY PM PEAK HOUR			
	W/O PROJECT		WITH PROJECT		W/O PROJECT		WITH PROJECT	
	NB	SB	NB	SB	NB	SB	NB	SB
Silverado Trail North of Crystal Springs Road	B-.28 ⁽¹⁾	B-.25	B-.28	B-.25	B-.25	B-.21	B-.25	B-.21
Silverado Trail South of Crystal Springs Road	C-.29 ⁽¹⁾	B-.27	C-.29	B-.28	B-.26	B-.23	B-.26	B-.23

CUMULATIVE (YEAR 2030) HARVEST

LOCATION	FRIDAY PM PEAK HOUR				SATURDAY PM PEAK HOUR			
	W/O PROJECT		WITH PROJECT		W/O PROJECT		WITH PROJECT	
	NB	SB	NB	SB	NB	SB	NB	SB
Silverado Trail North of Crystal Springs Road	C-.31 ⁽¹⁾	B-.27	C-.31	B-.27	B-.28	B-.23	B-.28	B-.23
Silverado Trail South of Crystal Springs Road	C-.32 ⁽¹⁾	C-.30	C-.32	C-.31	C-.29	B-.26	C-.29	B-.26

⁽¹⁾ Level of service – demand/capacity
 Highway Capacity Manual, 6th Edition (2017) analysis methodology
 Source: Crane Transportation Group

TABLE 5 (a)

RURAL SIGNAL WARRANT EVALUATION

Silverado Trail/Crystal Springs Road

Do Volumes meet Caltrans Rural Warrant #3 Volume Criteria?

EXISTING

FRIDAY PM PEAK HOUR		SATURDAY PM PEAK HOUR	
WITHOUT PROJECT	WITH PROJECT	WITHOUT PROJECT	WITH PROJECT
NO	NO	NO	NO

YEAR 2025

FRIDAY PM PEAK HOUR		SATURDAY PM PEAK HOUR	
WITHOUT PROJECT	WITH PROJECT	WITHOUT PROJECT	WITH PROJECT
NO	NO	NO	NO

CUMULATIVE (YEAR 2030)

FRIDAY PM PEAK HOUR		SATURDAY PM PEAK HOUR	
WITHOUT PROJECT	WITH PROJECT	WITHOUT PROJECT	WITH PROJECT
NO	NO	NO	NO

TABLE 5 (b)

RURAL SIGNAL WARRANT EVALUATION

Silverado Trail/Deer Park Road

Do Volumes meet Caltrans Rural Warrant #3 Volume Criteria?

EXISTING

FRIDAY PM PEAK HOUR		SATURDAY PM PEAK HOUR	
WITHOUT PROJECT	WITH PROJECT	WITHOUT PROJECT	WITH PROJECT
YES	YES	YES	YES

YEAR 2025

FRIDAY PM PEAK HOUR		SATURDAY PM PEAK HOUR	
WITHOUT PROJECT	WITH PROJECT	WITHOUT PROJECT	WITH PROJECT
YES	YES	YES	YES

CUMULATIVE (YEAR 2030)

FRIDAY PM PEAK HOUR		SATURDAY PM PEAK HOUR	
WITHOUT PROJECT	WITH PROJECT	WITHOUT PROJECT	WITH PROJECT
YES	YES	YES	YES

Source: Crane Transportation Group

TABLE 6

PROJECT TRIP GENERATION

	DAILY TRIPS			Maximum PM Hourly % of Daily 2-Way Traffic**	Resultant Project PM Peak Hour 2-Way Trip Generation
	Existing*	Existing* +Project	Increase Due to Project		
Friday	0	48	48	21%	10
Saturday	0	37	37	19%	7

* Napa County Winery Trip Generation Worksheets

** 2 Friday and 2 Saturday 24-hour Traffic Counts at driveways of 3 other similar wineries. The highest percentages from the 3 other driveways were used for analysis purposes in this report.

Source: Crane Transportation Group

FIGURES

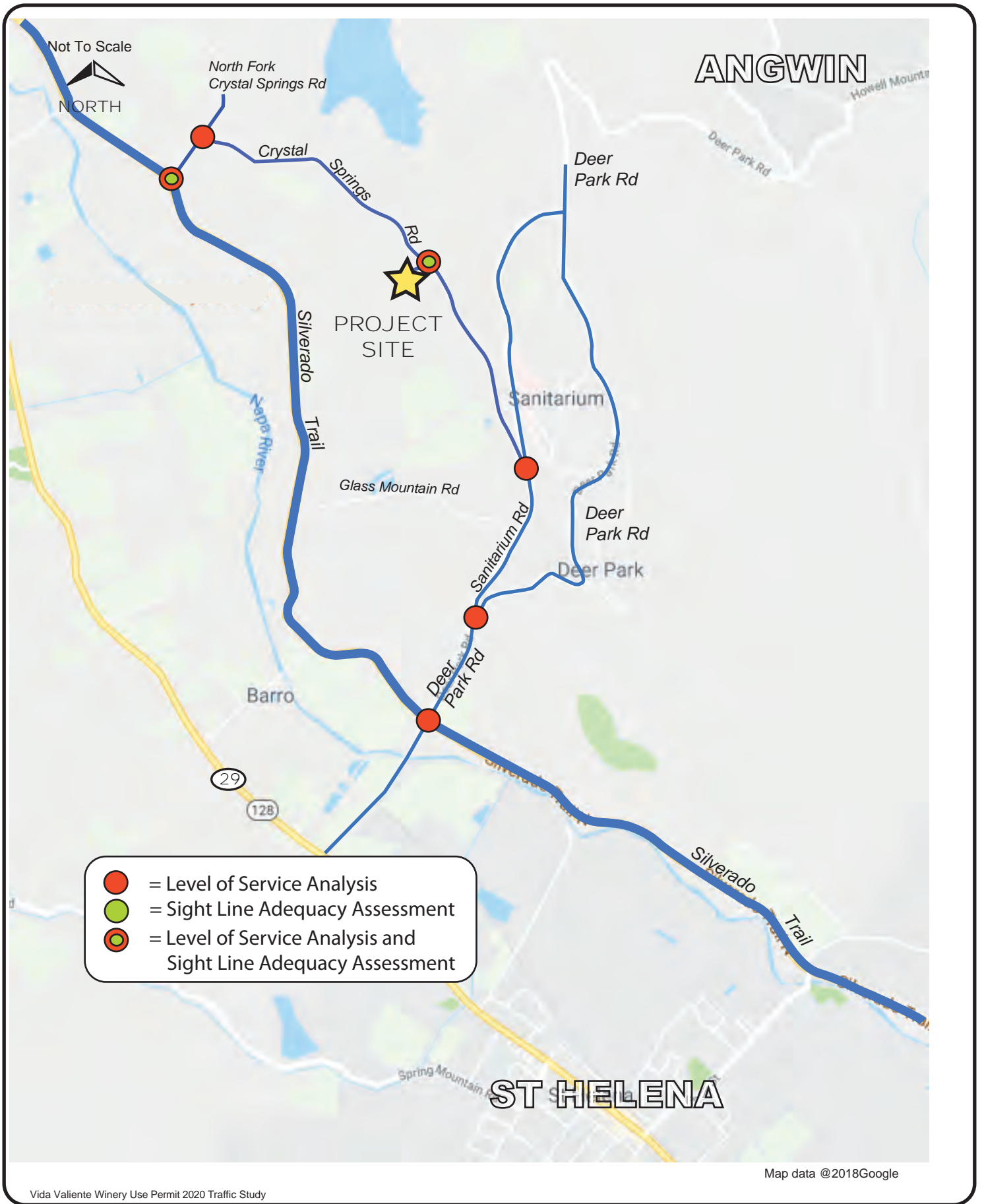

- = Level of Service Analysis
- = Sight Line Adequacy Assessment
- = Level of Service Analysis and Sight Line Adequacy Assessment

Figure 1
Area Map and Intersections to be Analyzed

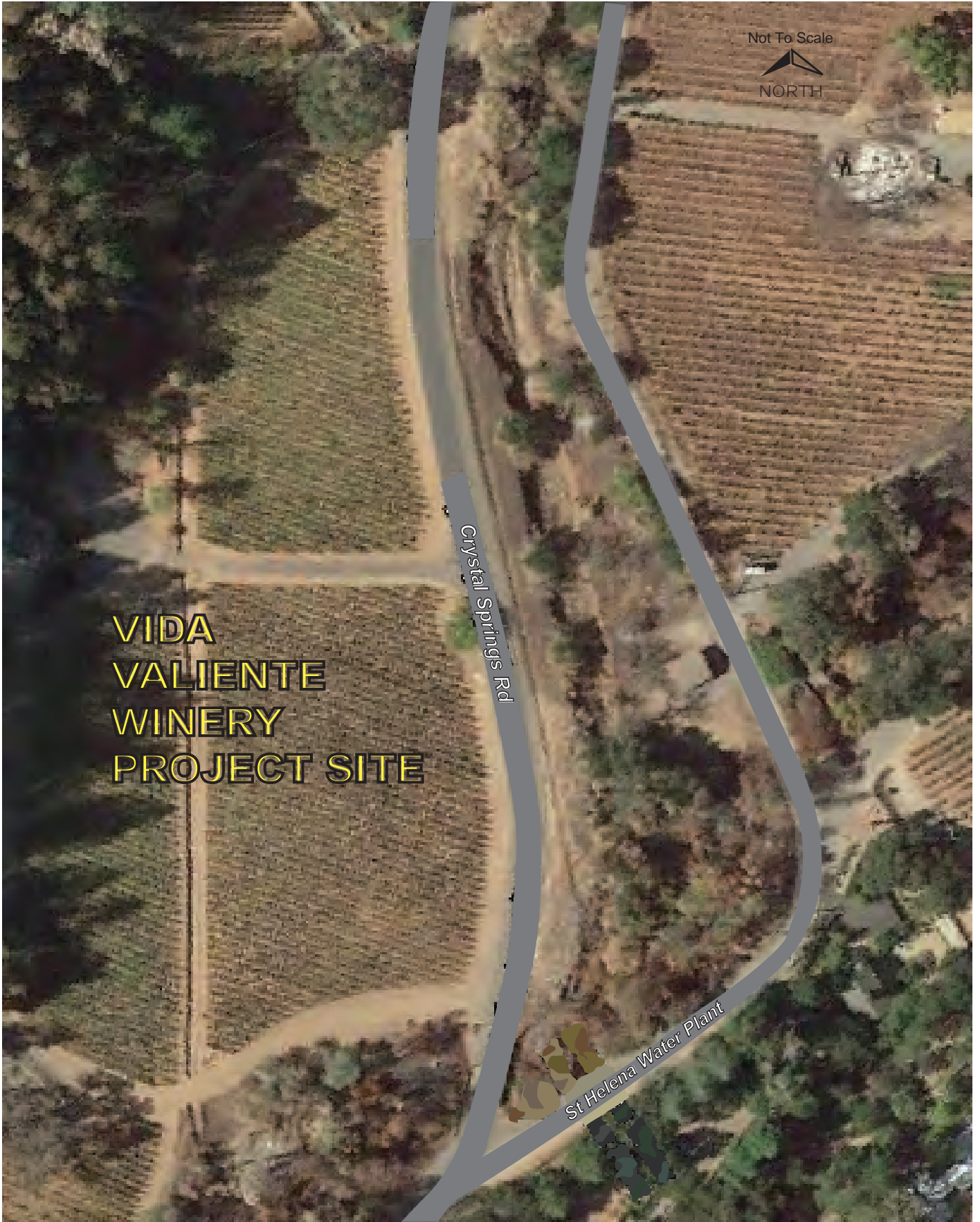

**VIDA
VALIENTE
WINERY
PROJECT SITE**

Not To Scale



Crystal Springs Rd

St Helena Water Plant

Figure 2
Site Specific Air Photo

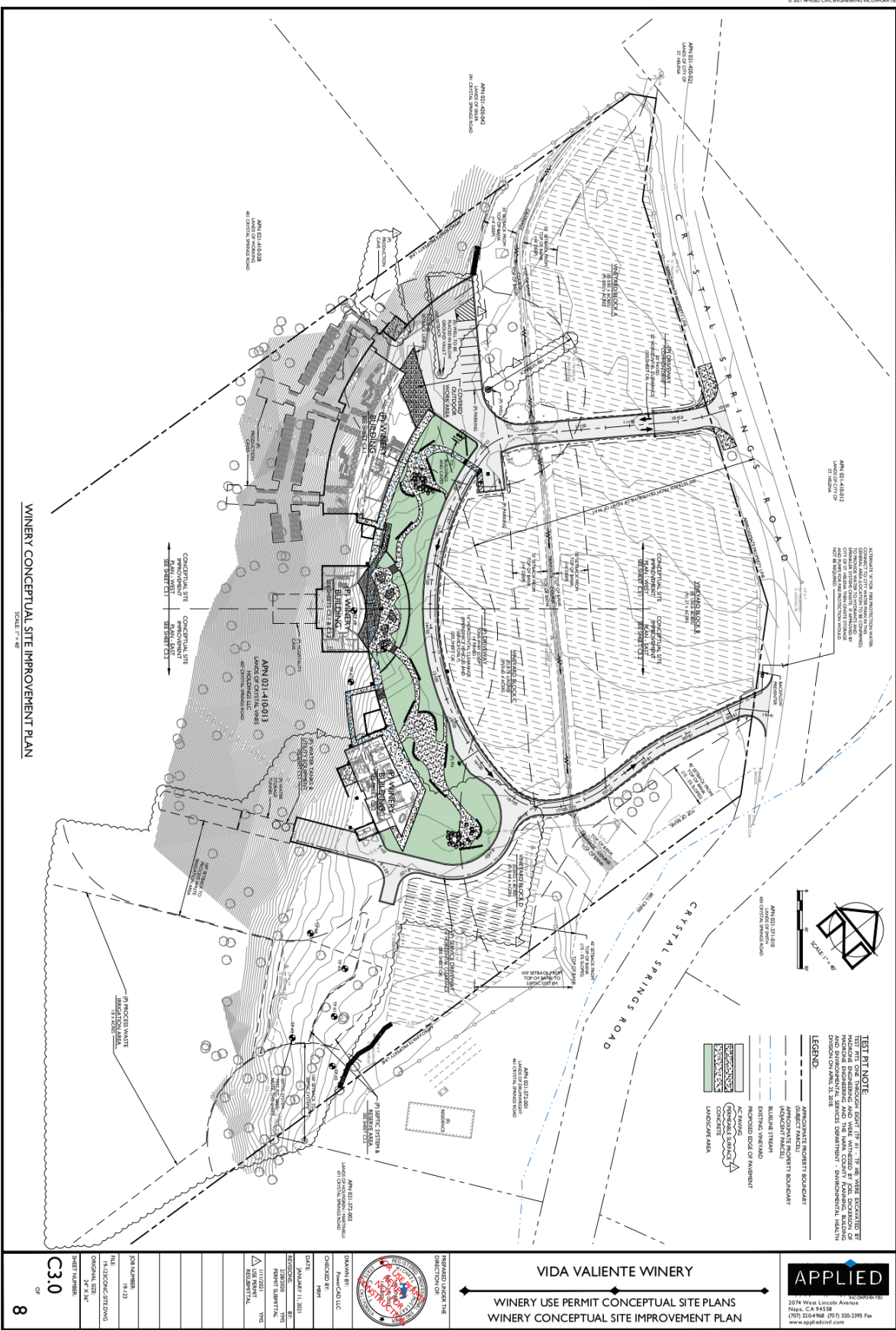

WINERY CONCEPTUAL SITE IMPROVEMENT PLAN
 SCALE: 1" = 40'

Vida Valiente Winery Use Permit 2020 Traffic Study

Figure 3
 Site Plan



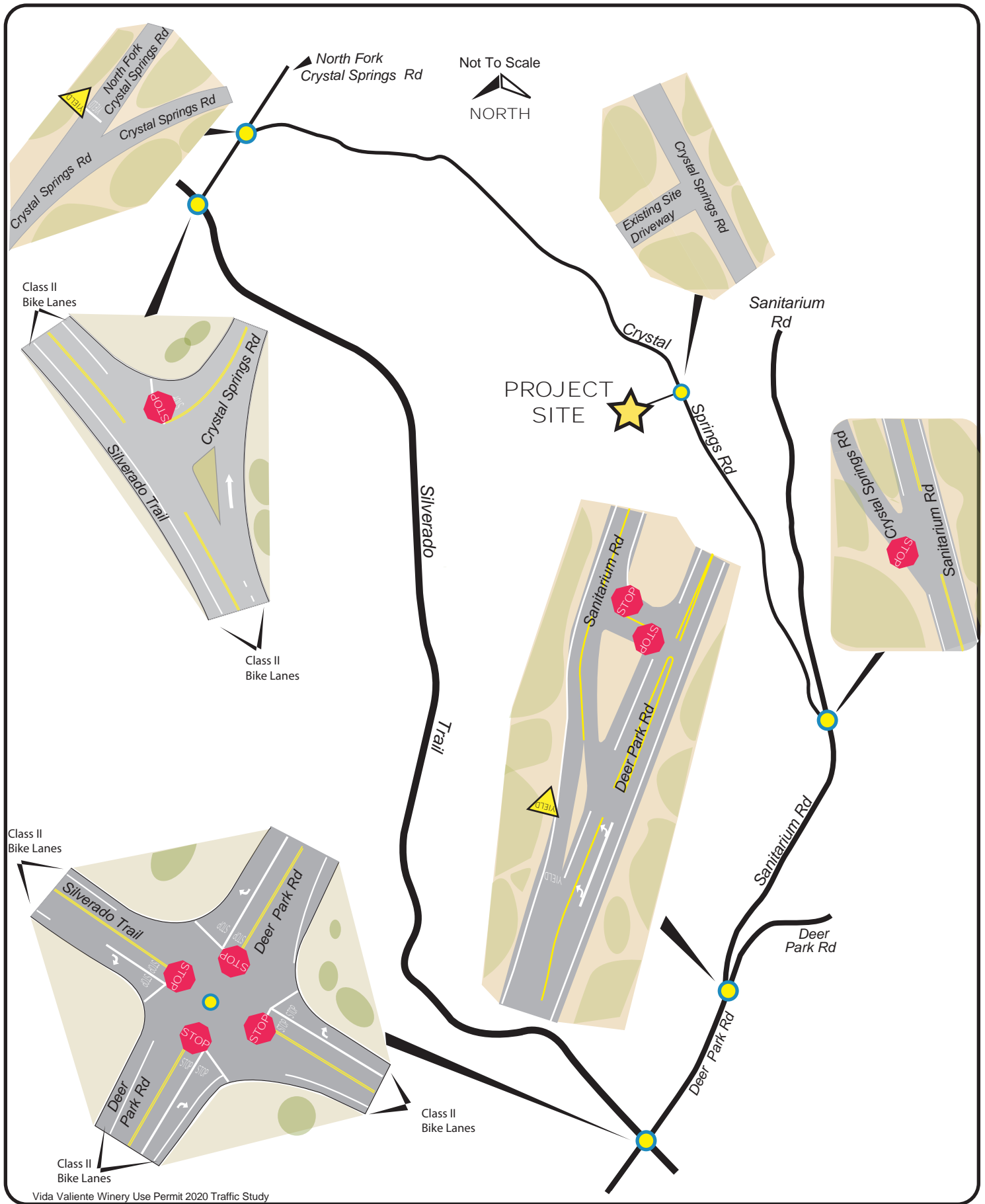
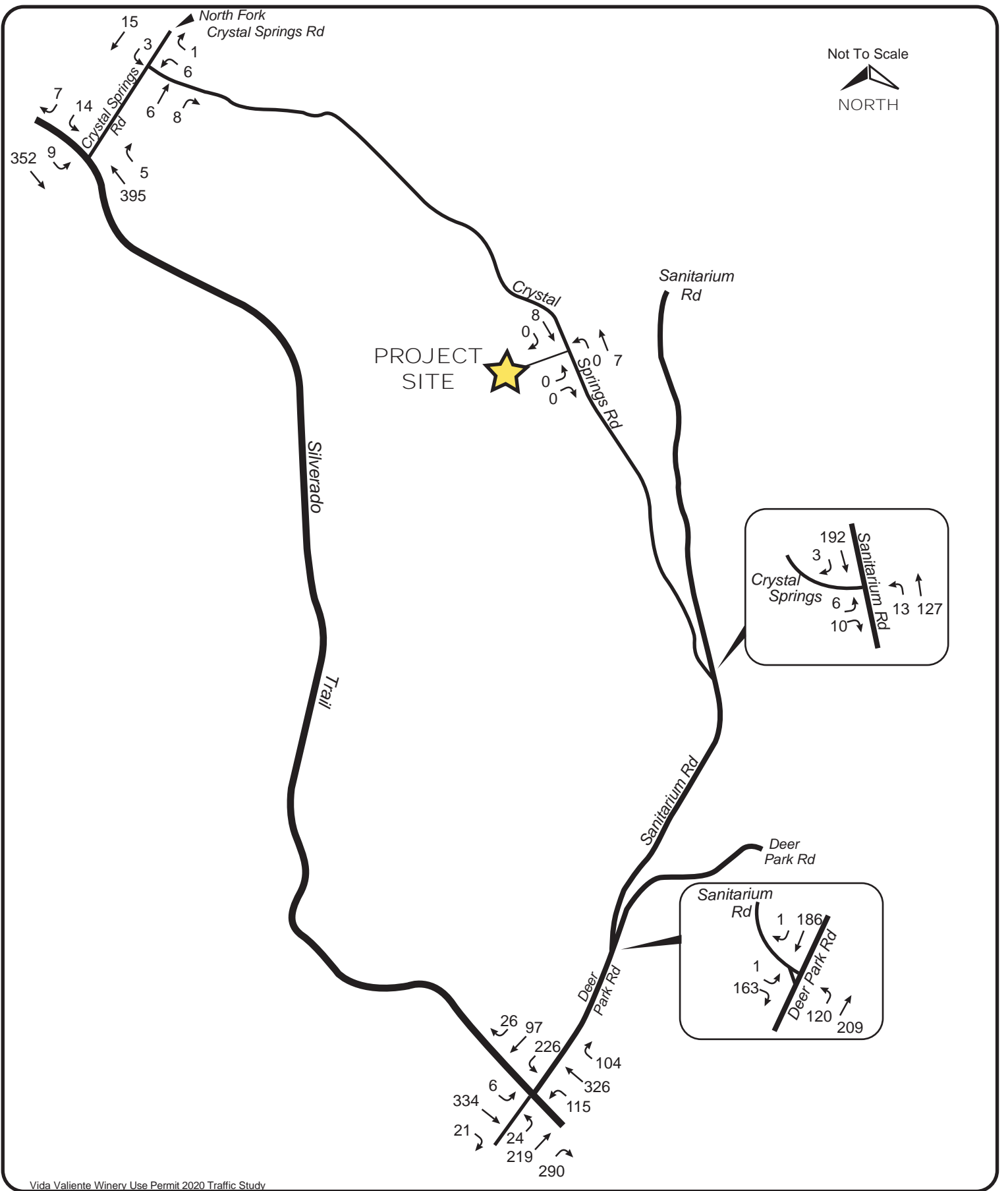

Figure 4
Existing Lane Geometrics and
Intersection Control



Vida Valiente Winery Use Permit 2020 Traffic Study

Figure 5

Existing 2019 Harvest Friday (without Project)
PM Peak Hour (3:15-4:15) Volumes

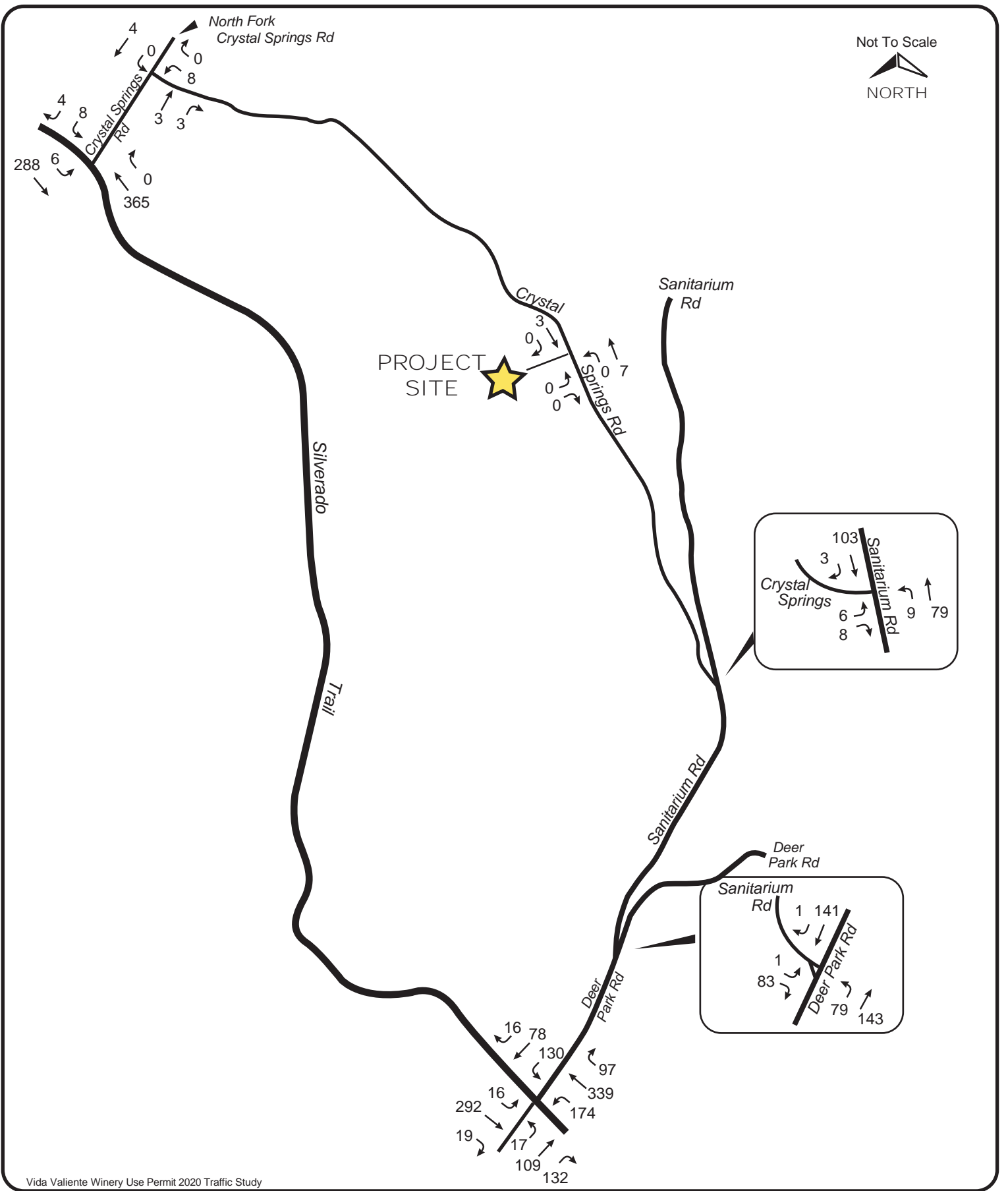

Vida Valiente Winery Use Permit 2020 Traffic Study

Figure 6

Existing 2019 Harvest Saturday (without Project)
PM Peak Hour (2:45-3:45) Volumes

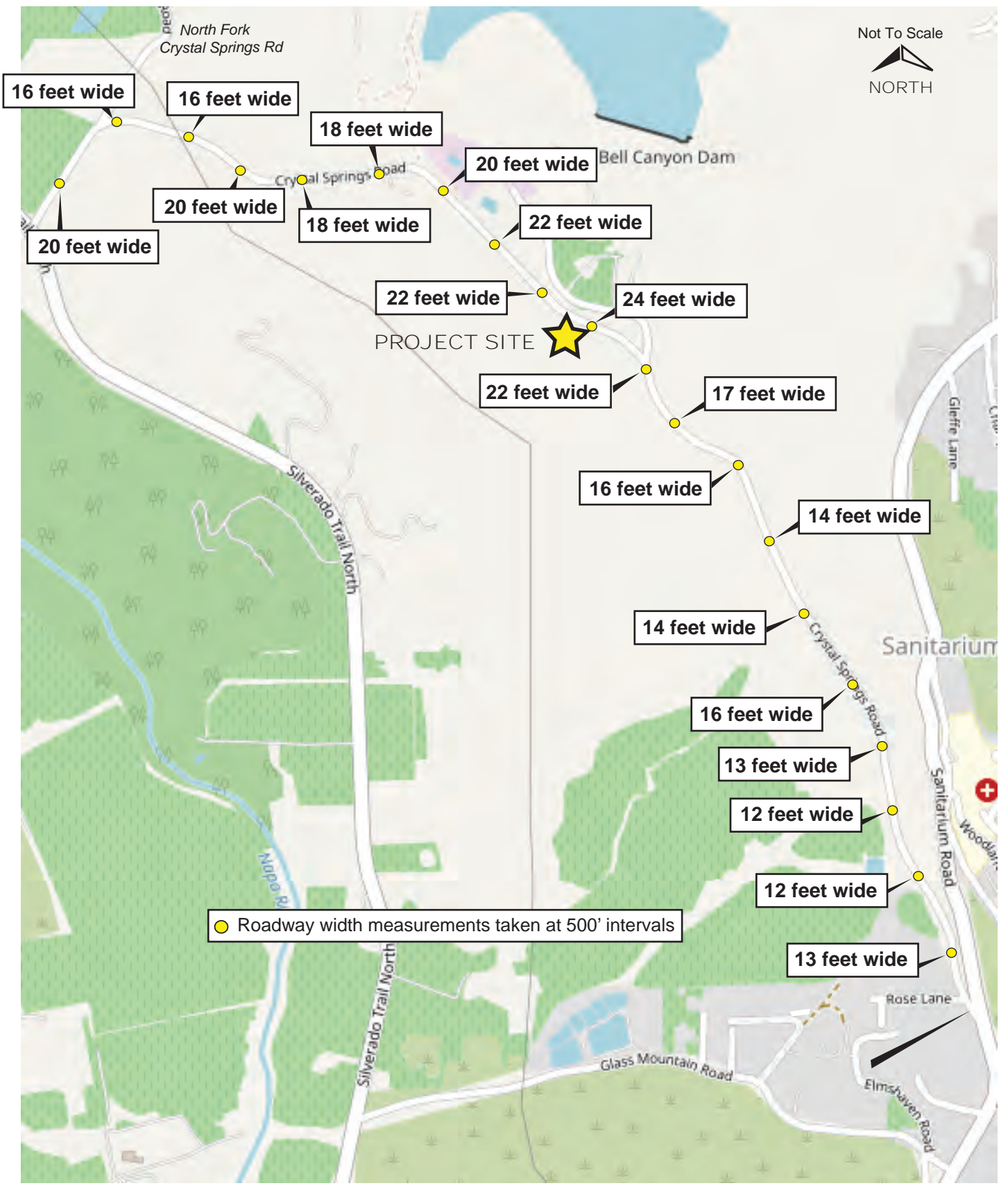

Vida Valiente Winery Use Permit 2020 Traffic Study

Figure 7
Crystal Springs Road
Pavement Widths

Not To Scale

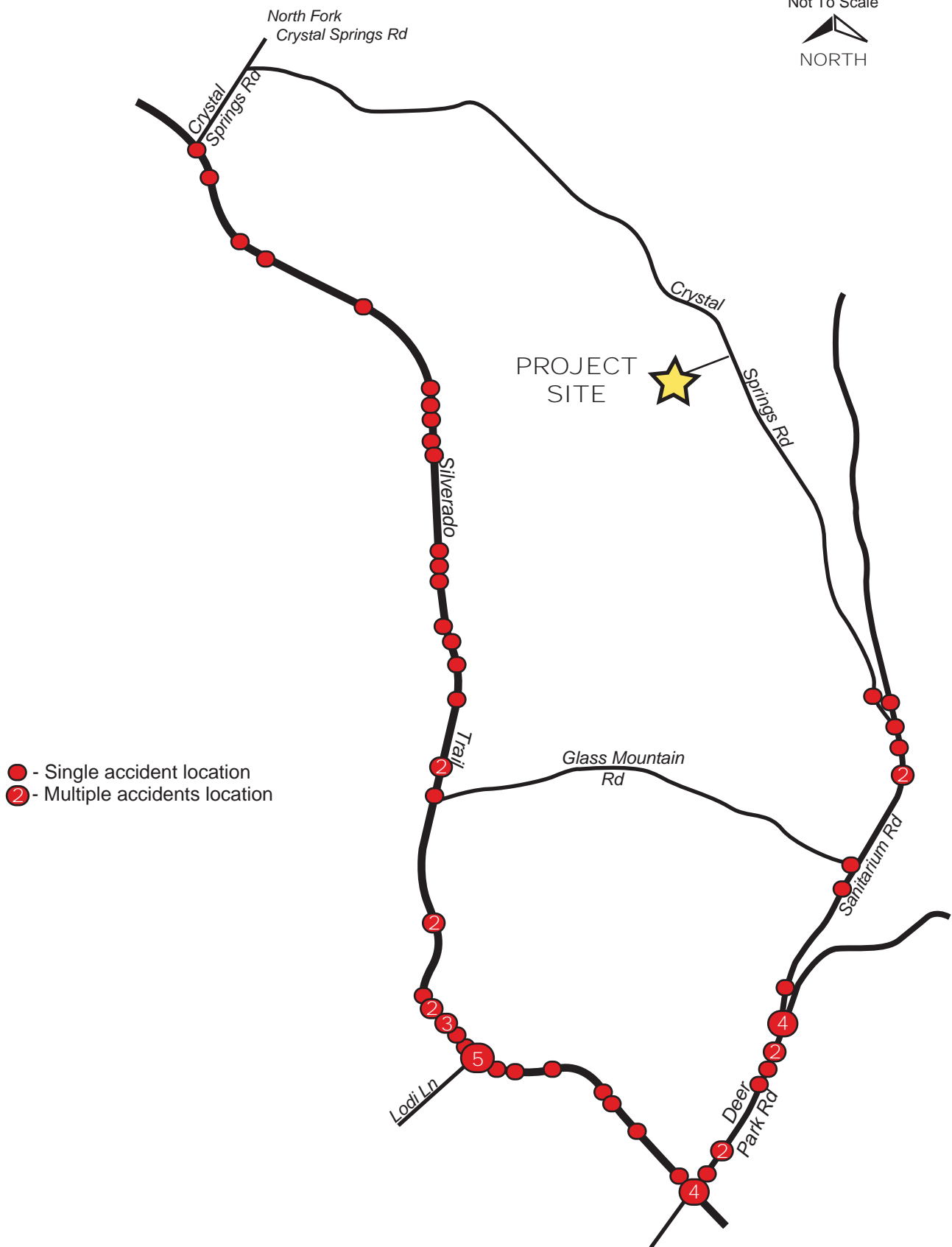

Vida Valiente Winery Use Permit 2020 Traffic Study

Figure 8
Accidents in the Vicinity
of the Project Site - 2014 - 2019



CRANE TRANSPORTATION GROUP

Not To Scale



— = Class II Bicycle Lanes
No Sidewalks in Vicinity
No Transit in Vicinity

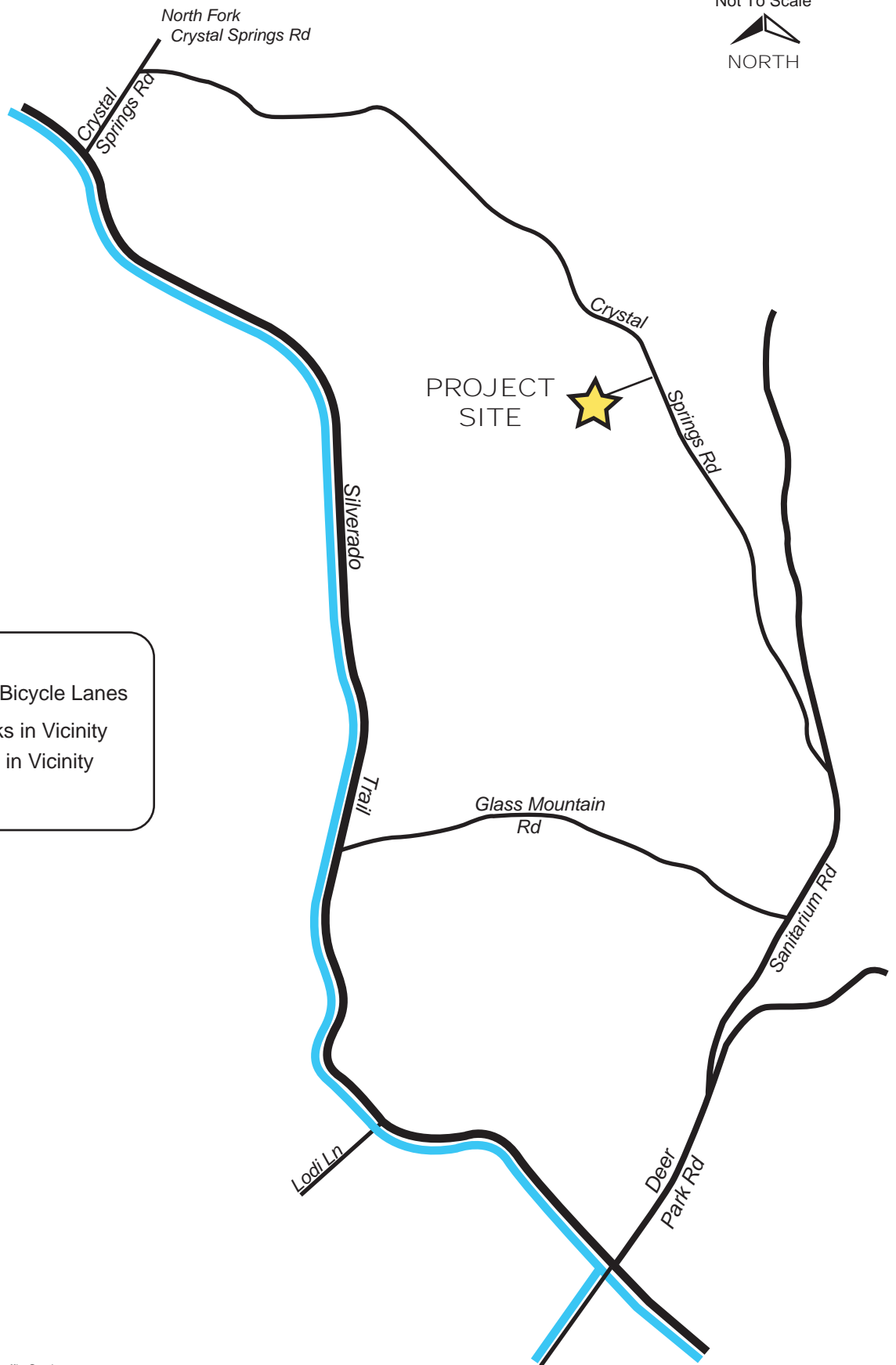

Vida Valiente Winery Use Permit 2020 Traffic Study

Figure 9

Existing Bicycle, Transit and Pedestrian
Facilities in Vicinity of Project Site



CRANE TRANSPORTATION GROUP

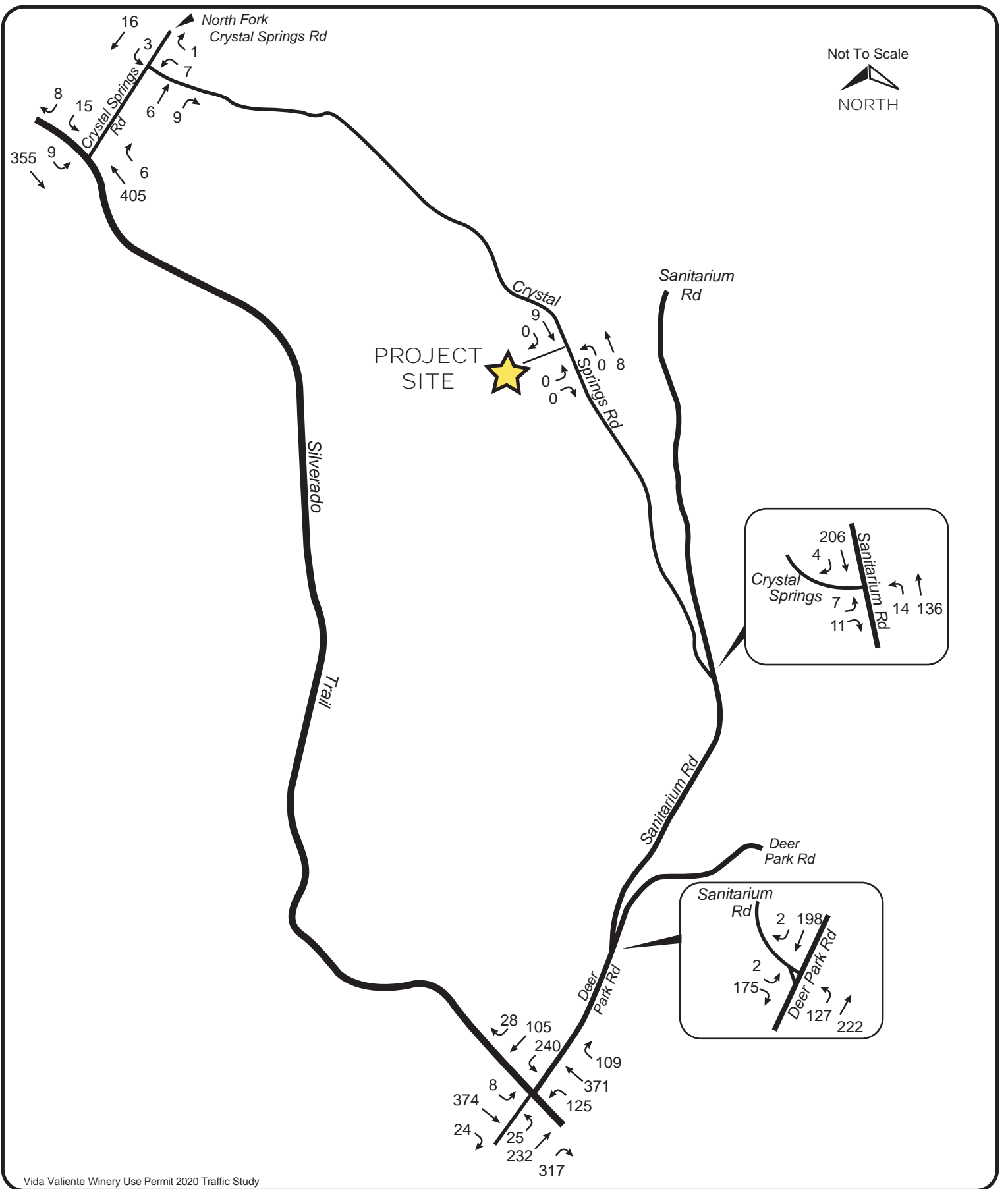

Vida Valiente Winery Use Permit 2020 Traffic Study

Figure 10
Year 2025 Harvest Friday (without Project)
PM Peak Hour Volumes

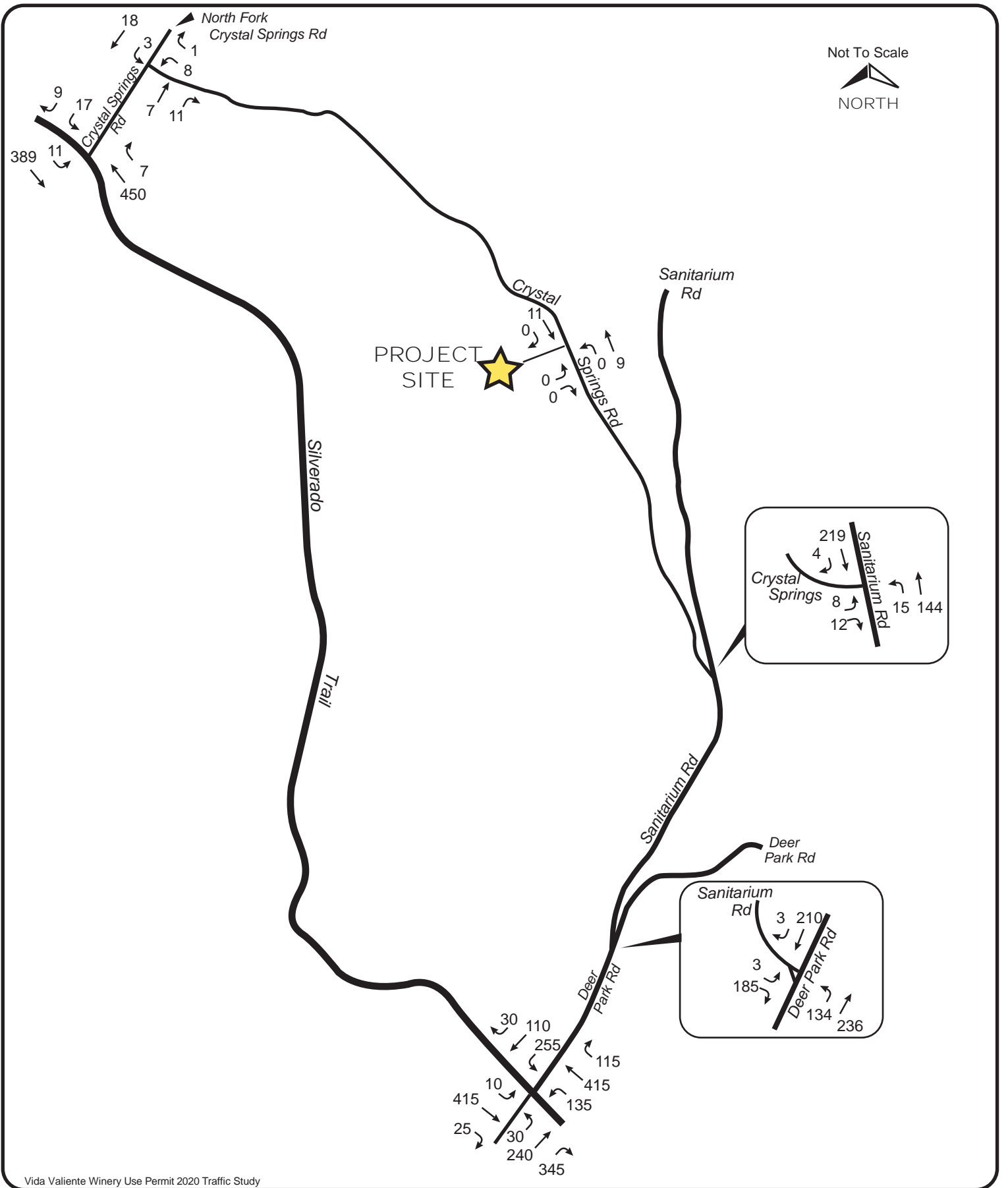

Vida Valiente Winery Use Permit 2020 Traffic Study

Figure 12

Cumulative (Year 2030) Harvest Friday (without Project) PM Peak Hour Volumes

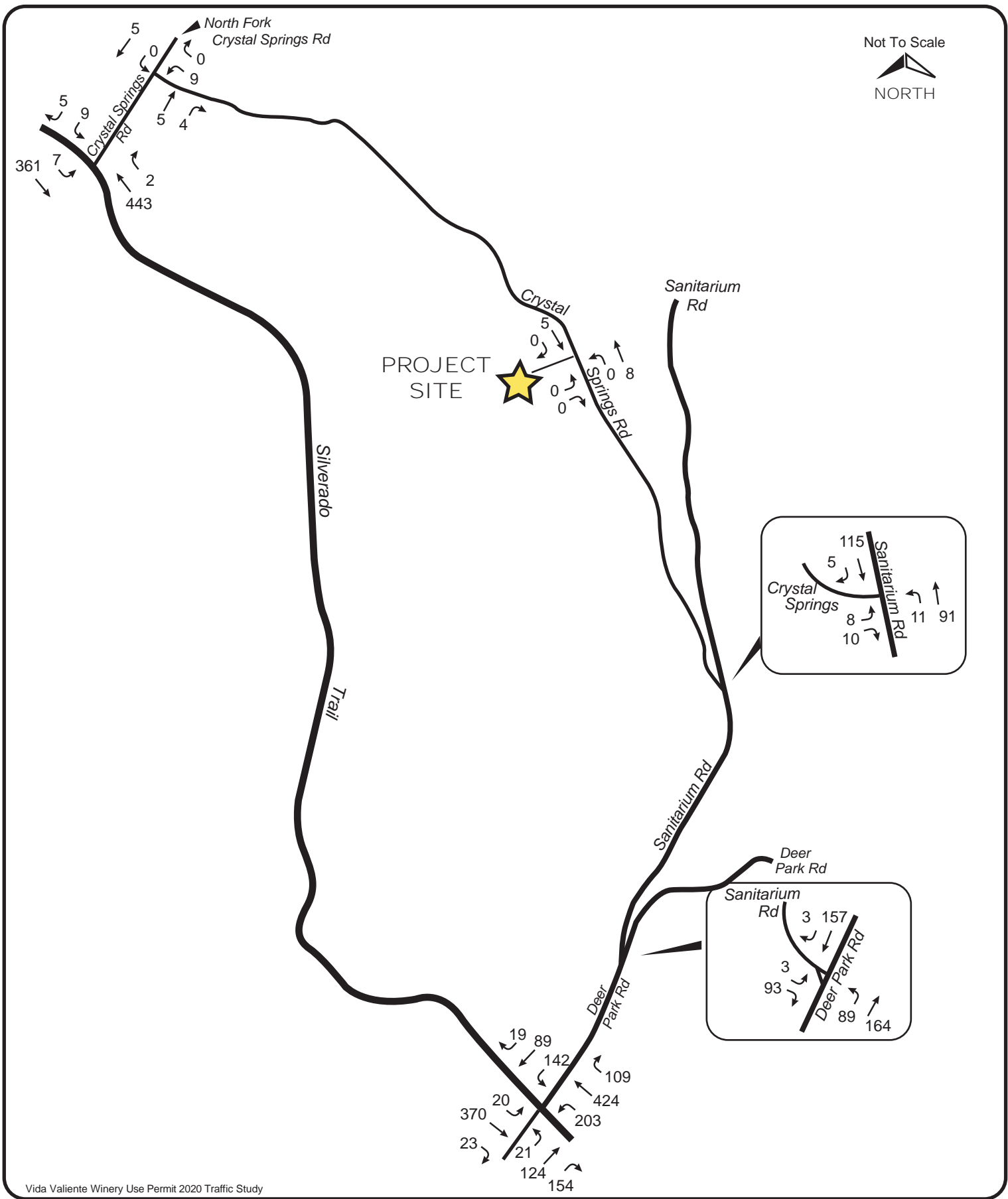

Vida Valiente Winery Use Permit 2020 Traffic Study

Figure 13
 Cumulative (Year 2030) Harvest Saturday
 (without Project) PM Peak Hour Volumes

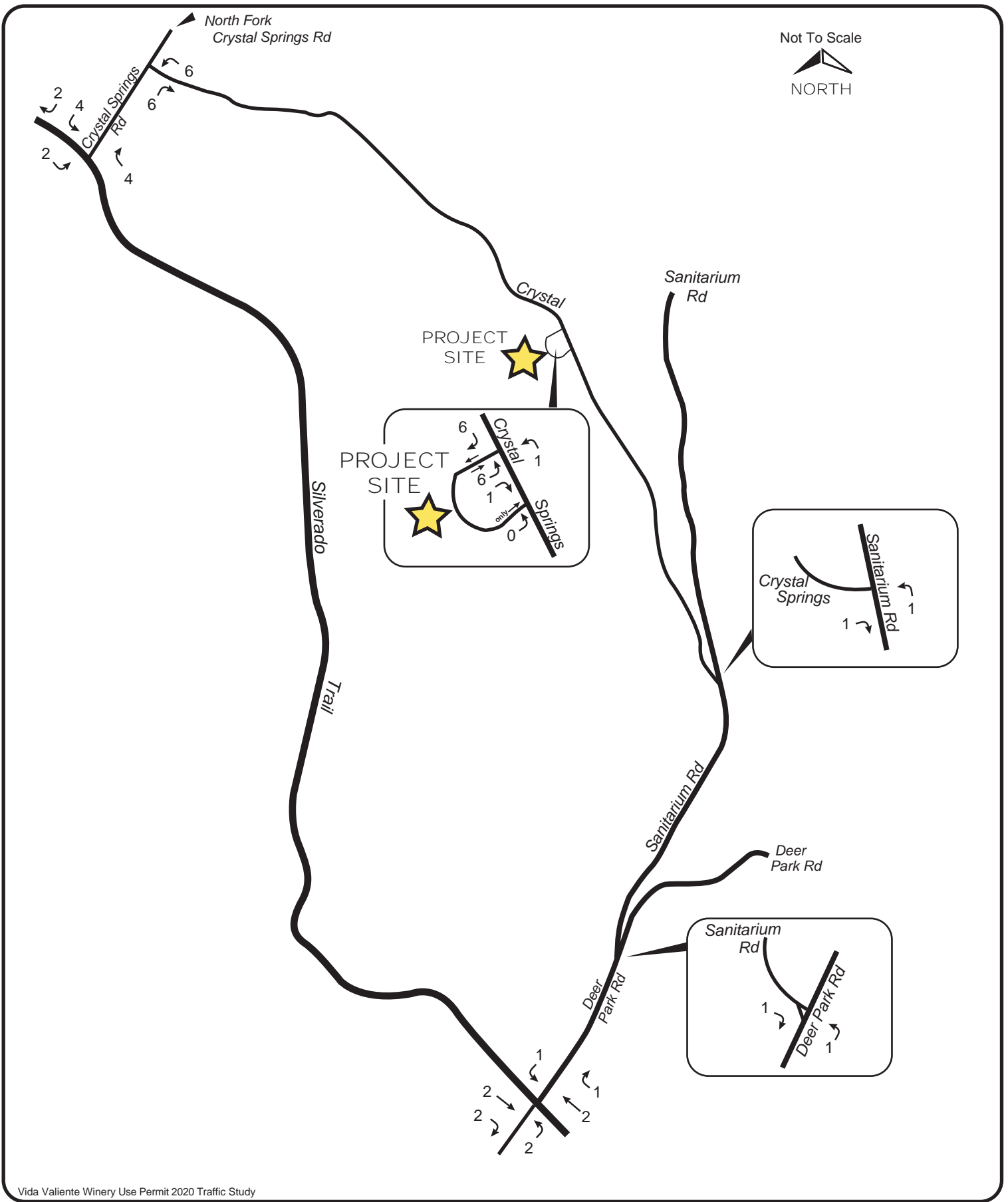

Vida Valiente Winery Use Permit 2020 Traffic Study

Figure 14

Harvest Friday PM Peak Hour
Project Increment Volumes

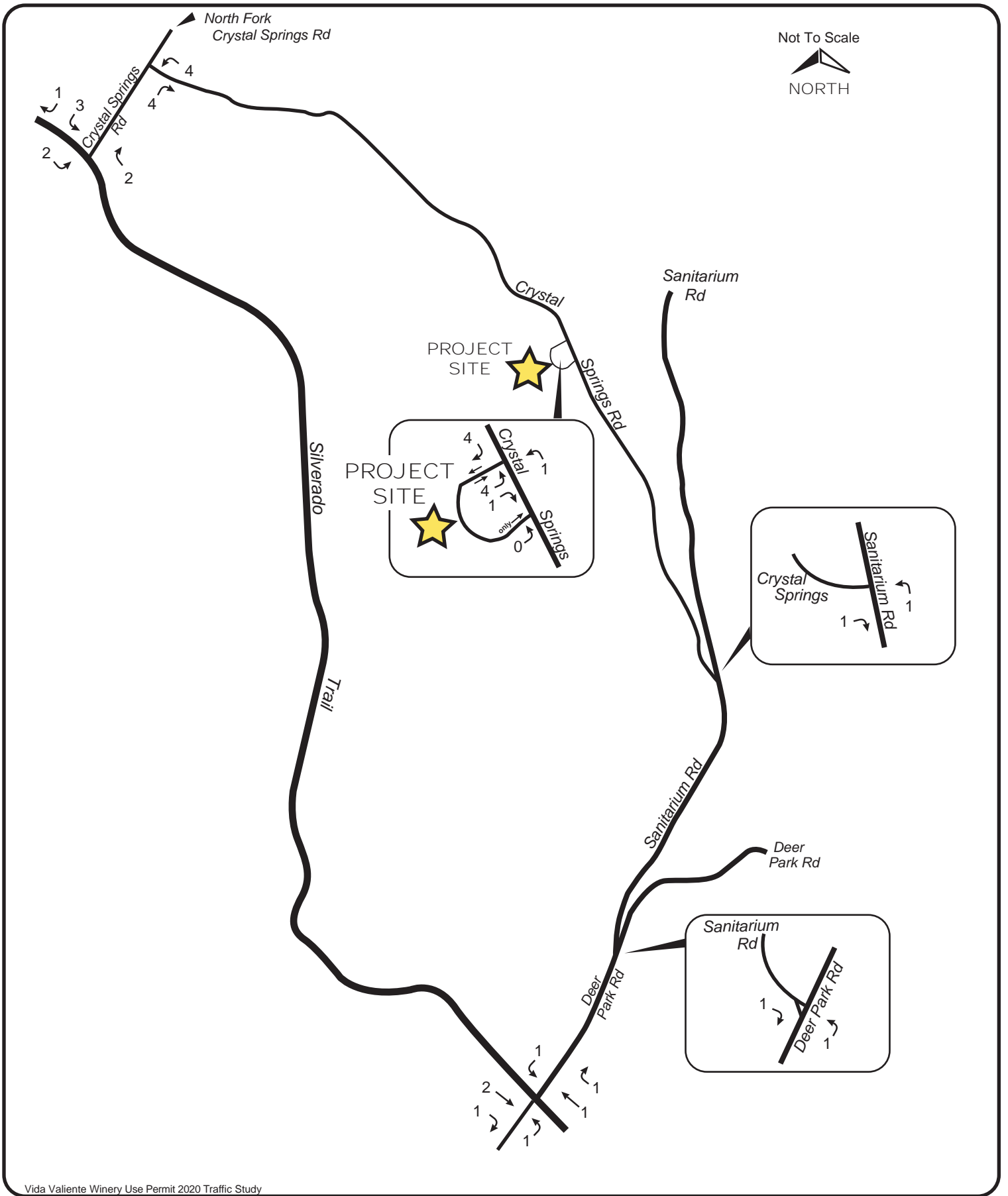

Vida Valiente Winery Use Permit 2020 Traffic Study

Figure 15

Harvest Saturday PM Peak Hour
Project Increment Volumes

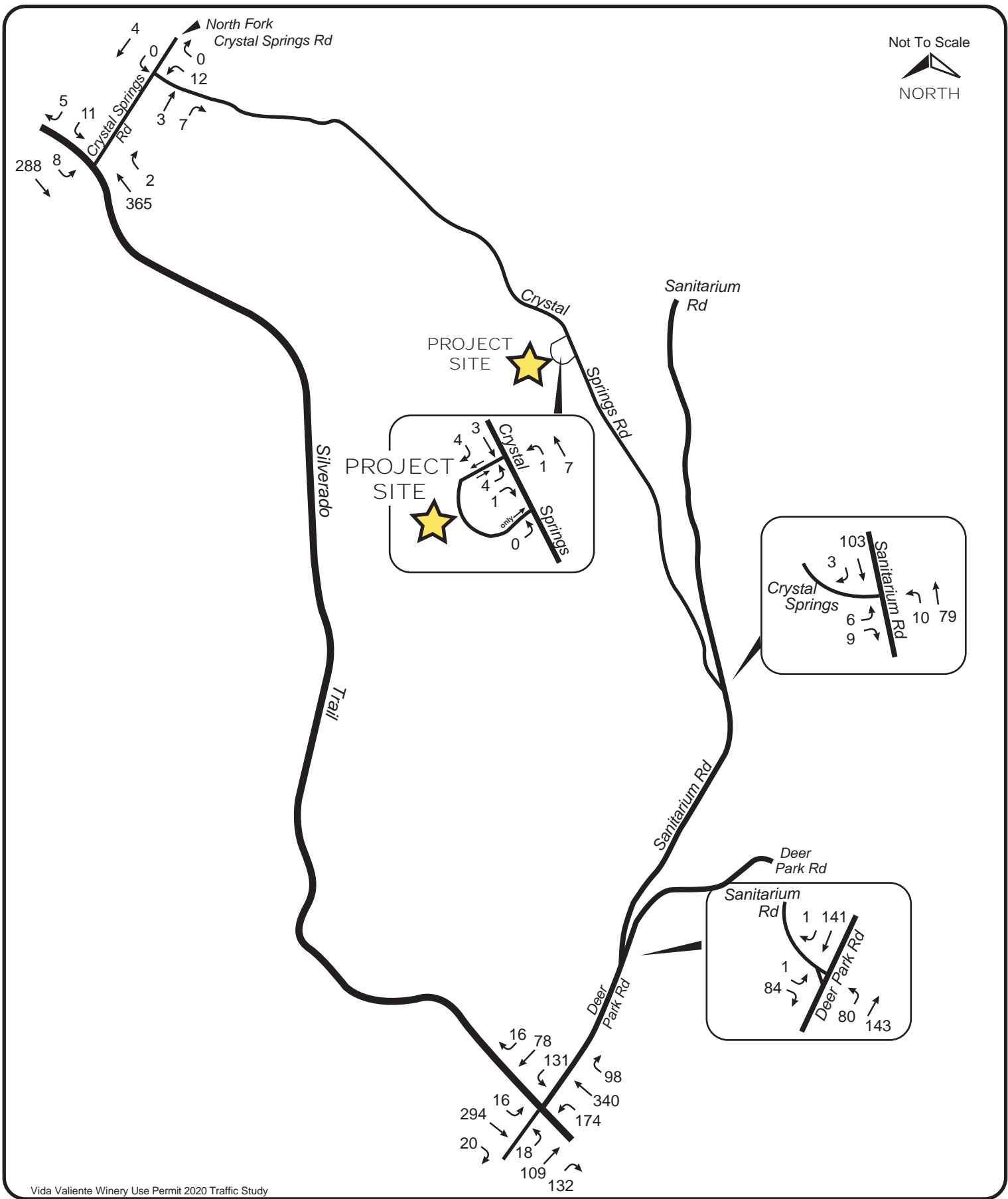

Vida Valiente Winery Use Permit 2020 Traffic Study

Figure 17

Existing 2019 Harvest Saturday
(with Project) PM Peak Hour Volumes

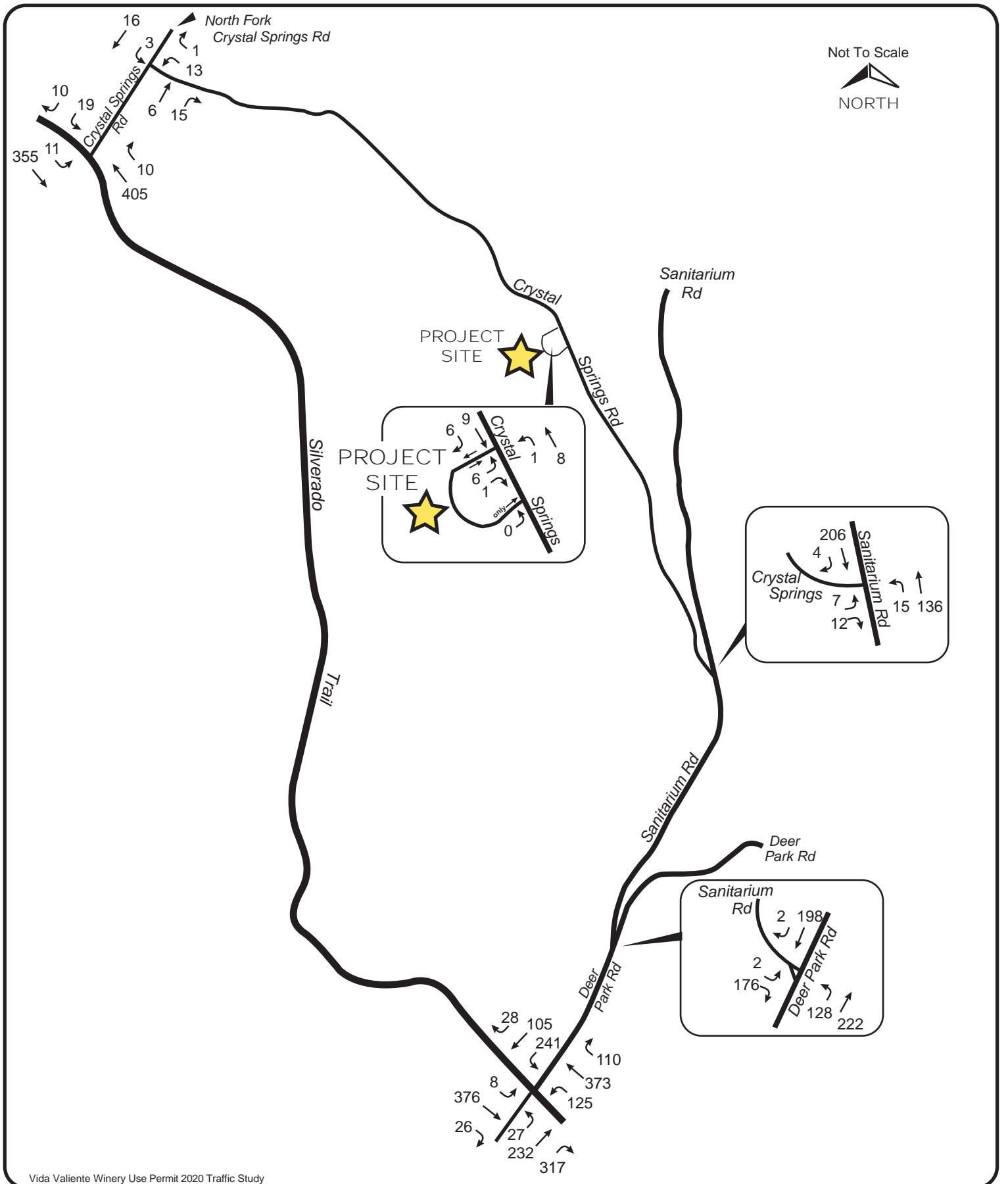

Vida Valiente Winery Use Permit 2020 Traffic Study

Figure 18

Year 2025 Harvest Friday (with Project)
PM Peak Hour Volumes

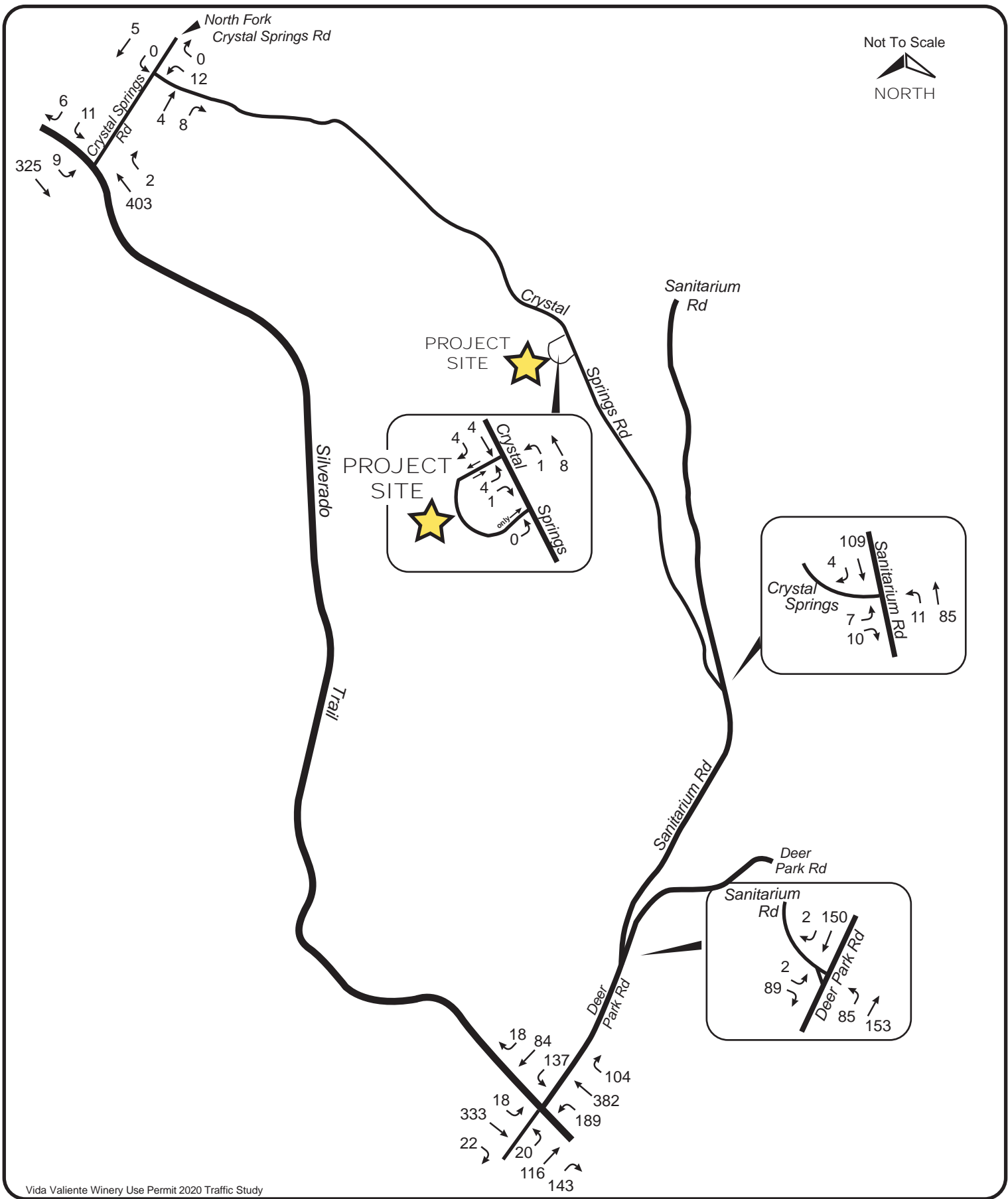

Vida Valiente Winery Use Permit 2020 Traffic Study

Figure 19
 Year 2025 Harvest Saturday (with Project)
 PM Peak Hour Volumes

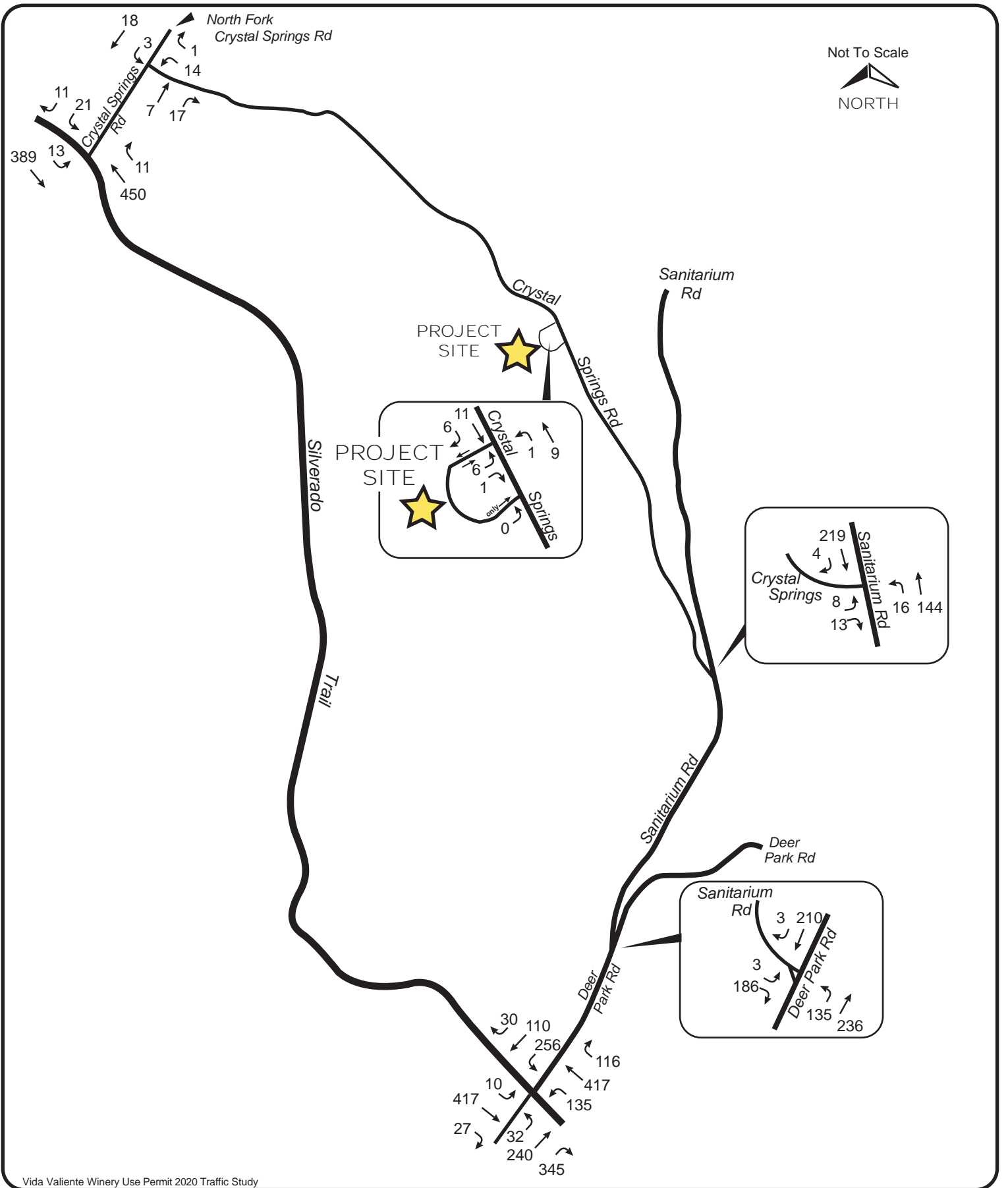

Vida Valiente Winery Use Permit 2020 Traffic Study

Figure 20

Cumulative (Year 2030) Harvest Friday (with Project) PM Peak Hour Volumes

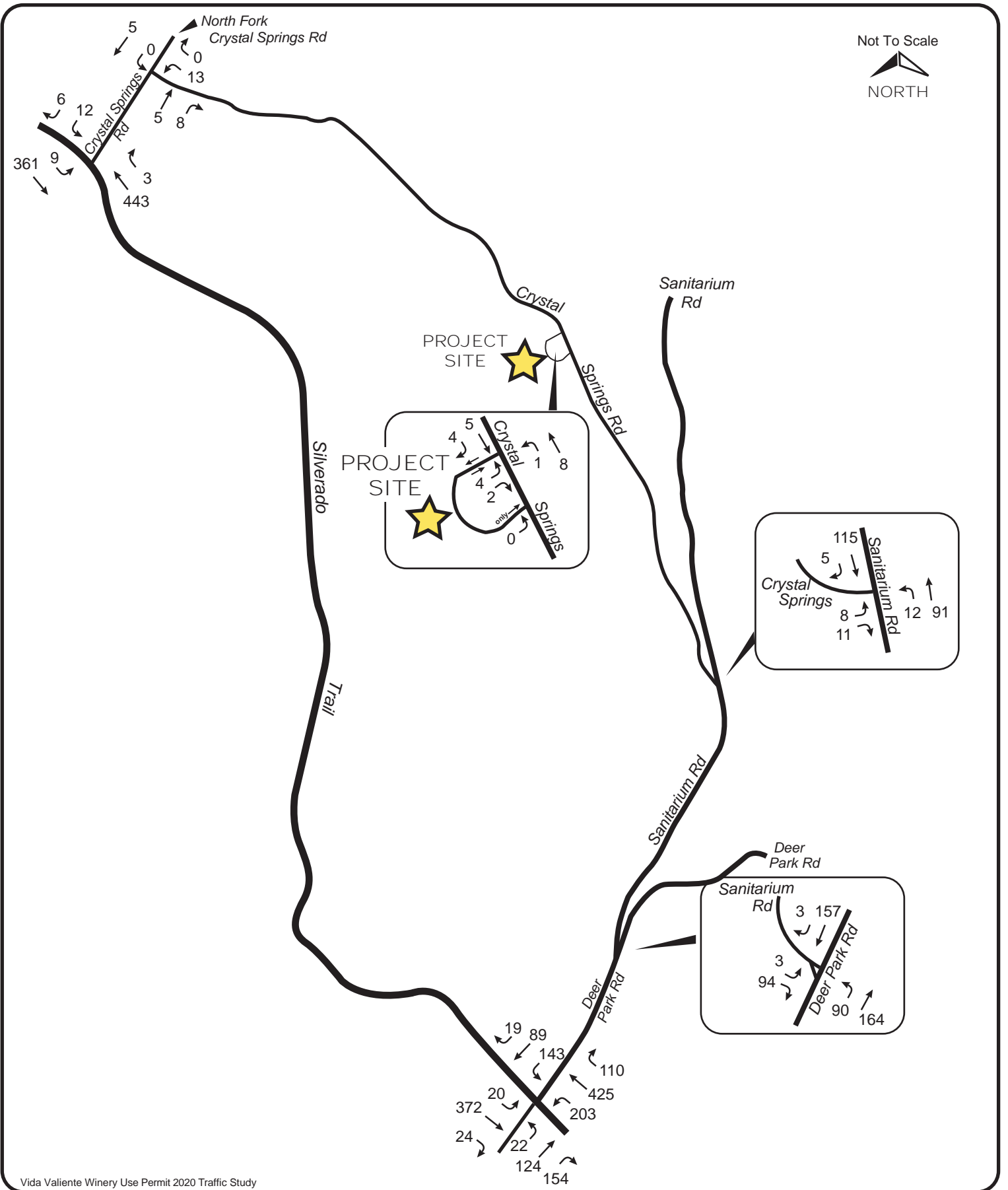

Figure 21
Cumulative (Year 2030) Harvest Saturday
(with Project) PM Peak Hour Volumes

APPENDICES

**A
P
P
E
N
D
I
X

A**

Crystal Springs North Fork at Crystal Springs Rd

13-Sep-18 Friday

	Crystal Springs Rd Northbound				Crystal Springs North Fork Eastbound				Crystal Springs North Fork Westbound				
START TIME	LEFT	THRU	RIGHT	APP.TOTAL	LEFT	THRU	RIGHT	APP.TOTAL	LEFT	THRU	RIGHT	APP.TOTAL	Total
14:00	4	0	0	4	0	3	1	4	0	1	0	1	9
14:15	5	0	0	5	0	2	2	4	0	2	0	2	11
14:30	5	0	0	5	0	1	3	4	0	2	0	2	11
14:45	3	0	0	3	0	1	2	3	0	1	0	1	7
Total	17	0	0	17	0	7	8	15	0	6	0	6	38
15:00	2	0	0	2	0	0	3	3	0	4	0	4	9
15:15	2	0	0	2	0	3	1	4	0	4	0	4	10
15:30	1	0	0	1	0	1	4	5	0	1	0	1	7
15:45	1	0	0	1	0	0	2	2	2	2	0	4	7
Total	6	0	0	6	0	4	10	14	2	11	0	13	33
16:00	2	0	0	2	0	2	2	4	1	3	0	4	10
16:15	4	0	0	4	0	2	2	4	0	2	0	2	10
16:30	4	0	0	4	0	2	2	4	0	2	0	2	10
16:45	2	0	1	3	0	4	2	6	0	1	0	1	10
Total	12	0	1	13	0	10	8	18	1	8	0	9	40
17:00	3	0	0	3	0	0	2	2	0	3	0	3	8
17:15	1	0	0	1	0	1	1	2	0	2	0	2	5
17:30	0	0	0	0	0	0	2	2	0	2	0	2	4
17:45	1	0	1	2	0	0	4	4	1	0	0	1	7
Total	5	0	1	6	0	1	9	10	1	7	0	8	24
Grand Total	0	0	0	0	0	0	0	0	0	56	0	56	118
Apprch %	0.0%	100.0%	0.0%		0.0%	0.0%	0.0%		0.0%	100.0%	0.0%		
Total %	0.0%	52.5%	0.0%	52.5%	0.0%	0.0%	0.0%	0.0%	0.0%	47.5%	0.0%	47.5%	100.0%

PM PEAK HOUR	Crystal Springs Rd Northbound				Crystal Springs North Fork Eastbound				Crystal Springs North Fork Westbound				
START TIME	LEFT	THRU	RIGHT	APP.TOTAL	LEFT	THRU	RIGHT	APP.TOTAL	LEFT	THRU	RIGHT	APP.TOTAL	Total
Peak Hour =4:00-5:00													
16:00	2	0	0	2	0	2	2	4	1	3	0	4	10
16:15	4	0	0	4	0	2	2	4	0	2	0	2	10
16:30	4	0	0	4	0	2	2	4	0	2	0	2	10
16:45	2	0	1	3	0	4	2	6	0	1	0	1	10
Total Volume	12	0	1	13	0	10	8	18	1	8	0	9	40

Crystal Springs North Fork at Crystal Springs Rd

14-Sep-18 Saturday

START TIME	Crystal Springs Rd Northbound				Crystal Springs North Fork Eastbound				Crystal Springs North Fork Westbound				Total
	LEFT	THRU	RIGHT	APP.TOTAL	LEFT	THRU	RIGHT	APP.TOTAL	LEFT	THRU	RIGHT	APP.TOTAL	
12:00	2	0	0	2	0	1	2	3	0	3	0	3	8
12:15	1	0	1	2	0	1	3	4	0	0	0	0	6
12:30	1	0	0	1	0	1	3	4	0	2	0	2	7
12:45	1	0	0	1	0	1	0	1	0	1	0	1	3
Total	5	0	1	6	0	4	8	12	0	6	0	6	24
13:00	1	0	0	1	0	3	4	7	0	0	0	0	8
13:15	1	0	0	1	0	1	5	6	0	1	0	1	8
13:30	2	0	0	2	0	1	0	1	0	1	0	1	4
13:45	2	0	0	2	0	2	1	3	0	1	0	1	6
Total	6	0	0	6	0	7	10	17	0	3	0	3	26
14:00	2	0	0	2	0	1	1	2	0	1	0	1	6
14:15	3	0	0	3	0	1	3	4	0	1	0	1	7
14:30	0	0	0	0	0	2	2	4	0	0	0	0	4
14:45	5	0	0	5	0	1	1	2	0	2	0	2	9
Total	10	0	0	10	0	5	7	12	0	4	0	4	26
15:00	2	0	0	2	0	1	0	1	0	0	0	0	4
15:15	2	0	0	2	0	0	1	1	0	0	0	0	3
15:30	0	0	0	0	0	1	1	2	0	0	0	0	2
15:45	1	0	0	1	0	3	2	5	0	1	0	1	7
Total	5	0	0	5	0	5	4	9	0	1	0	1	16
16:00	1	0	0	1	0	0	1	1	1	1	0	2	4
16:15	1	0	0	1	0	1	0	1	0	1	0	1	3
16:30	7	0	0	7	0	0	5	5	0	2	0	2	14
16:45	0	0	1	1	0	0	2	2	0	0	0	0	3
Total	9	0	1	10	0	1	8	9	0	4	0	5	24
17:00	2	0	0	2	0	2	2	4	0	1	0	1	7
17:15	1	0	0	1	0	1	1	2	0	2	0	2	5
17:30	1	0	0	1	0	0	2	2	0	2	0	2	5
17:45	0	0	0	0	0	0	4	4	0	3	0	3	7
Total	4	0	0	4	0	3	9	12	0	8	0	8	24
Grand Total	0	0	0	0	0	0	0	0	0	56	0	56	118
Apprch %	0.0%	100.0%	0.0%		0.0%	0.0%	0.0%		0.0%	100.0%	0.0%		
Total %	0.0%	52.5%	0.0%	52.5%	0.0%	0.0%	0.0%	0.0%	0.0%	47.5%	0.0%	47.5%	100.0%

PM PEAK HOUR	Crystal Springs Rd Northbound				Crystal Springs North Fork Eastbound				Crystal Springs North Fork Westbound				Total
	LEFT	THRU	RIGHT	APP.TOTAL	LEFT	THRU	RIGHT	APP.TOTAL	LEFT	THRU	RIGHT	APP.TOTAL	
16:30	7	0	0	7	0	0	5	5	0	2	0	2	14
16:45	0	0	1	1	0	0	2	2	0	0	0	0	3
17:00	2	0	0	2	0	2	2	4	0	1	0	1	7
17:15	1	0	0	1	0	1	1	2	0	2	0	2	8
Total Volume	10	0	1	11	0	3	10	13	0	5	0	5	29

Peak Hour = 4:30-5:30

Silverado Trail N & Deer Park Rd

Peak Hour Turning Movement Count

ID: 18-08467-002
City: St Helena

Day: Saturday
Date: 09/15/2018

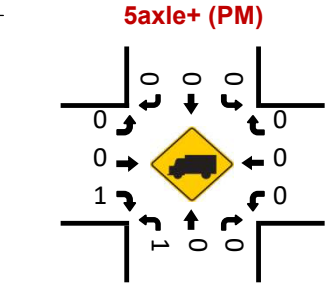
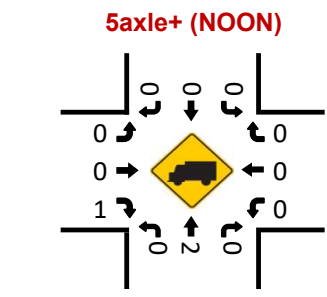
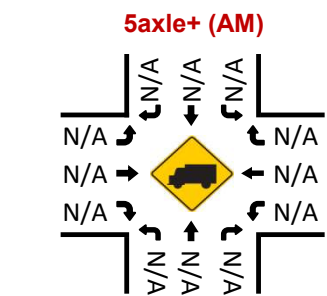
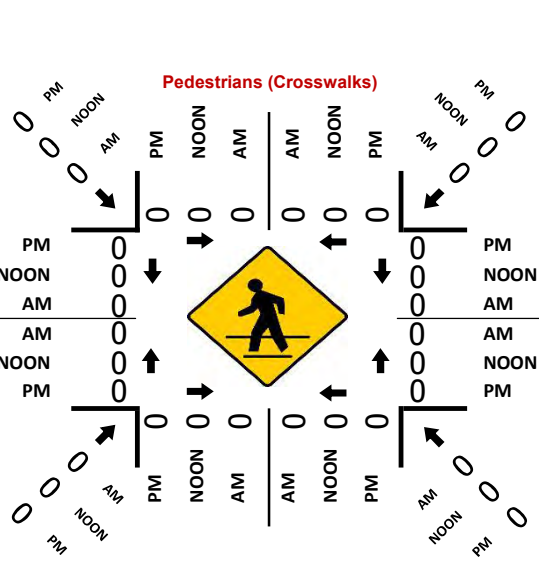
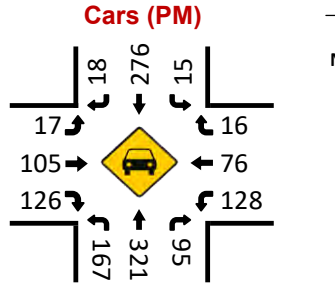
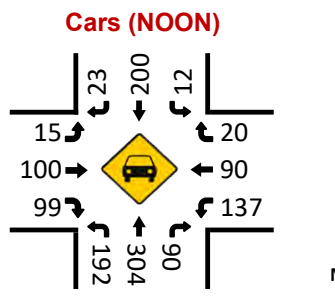
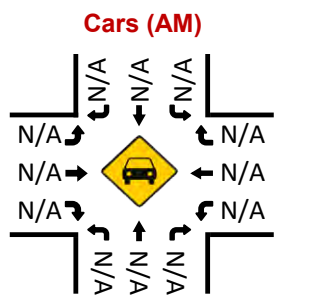
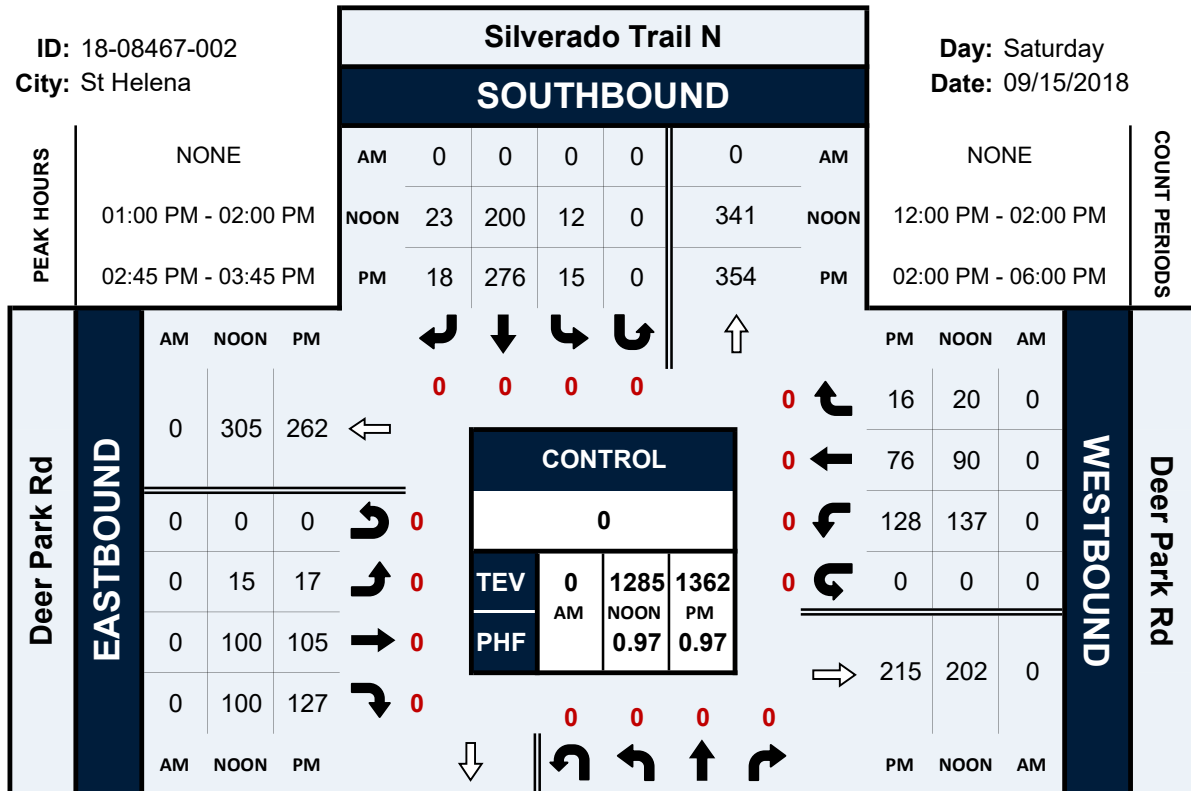

Silverado Trail N & Deer Park Rd

Peak Hour Turning Movement Count

ID: 18-08467-002
City: St Helena

Day: Friday
Date: 09/14/2018

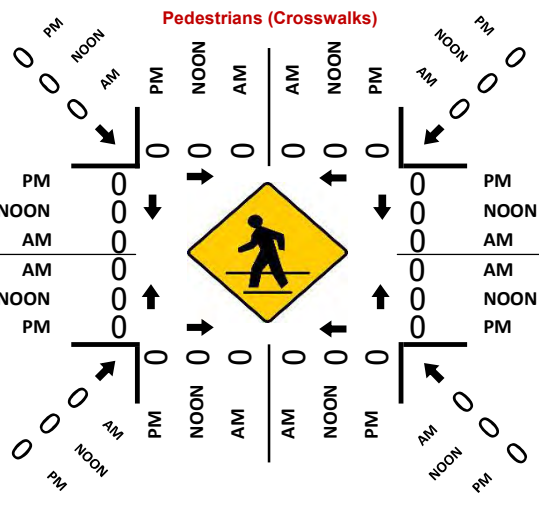
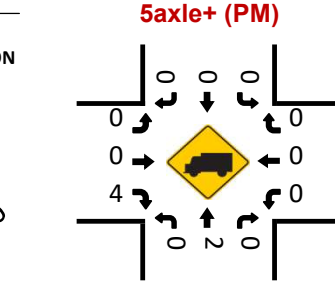
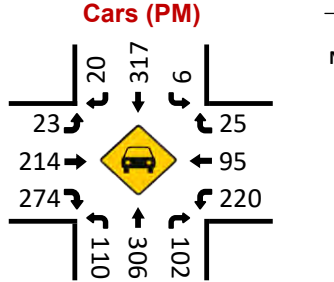
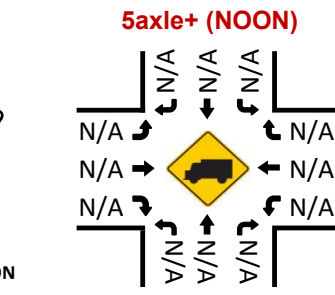
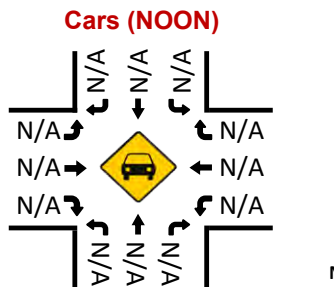
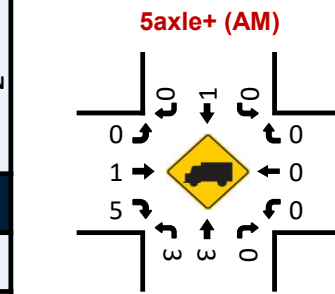
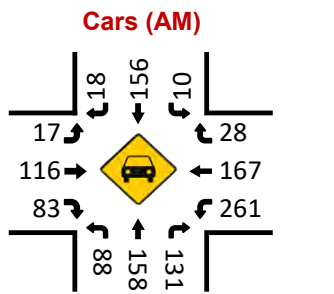
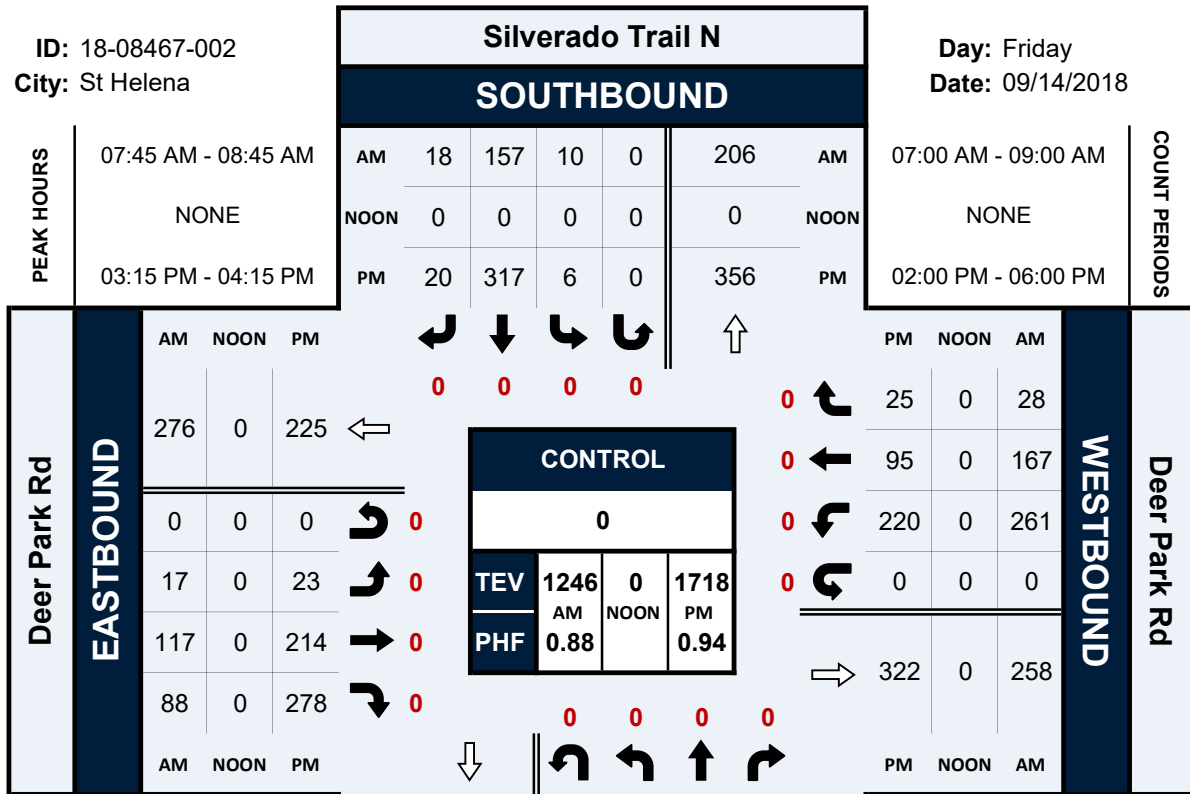

Silverado Trail N & Crystal Springs Rd

Peak Hour Turning Movement Count

ID: 18-08467-001
City: St Helena

Day: Friday
Date: 09/14/2018

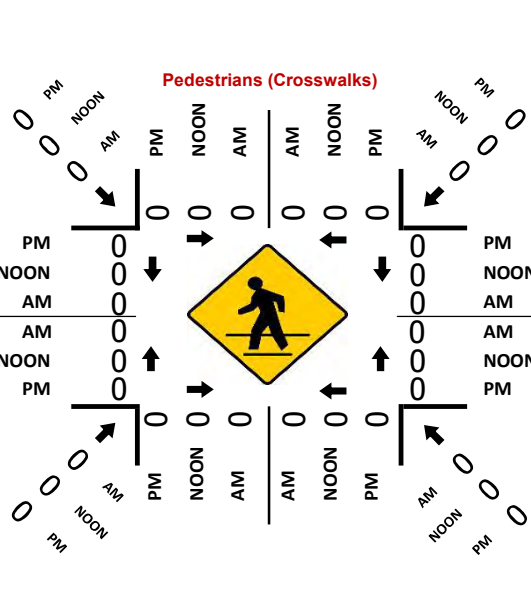
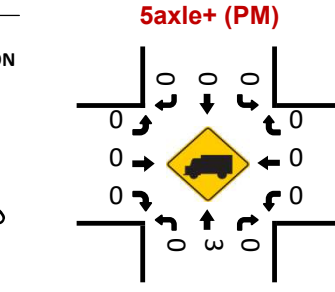
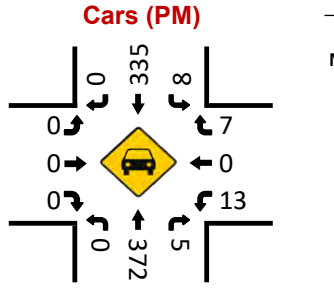
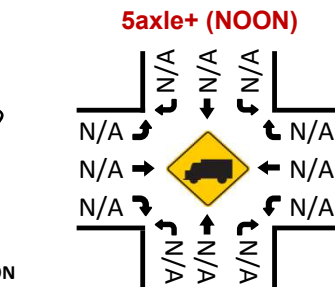
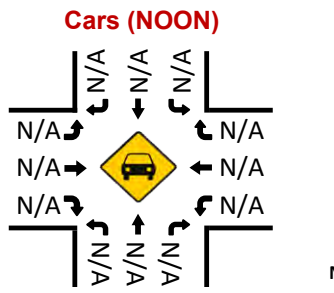
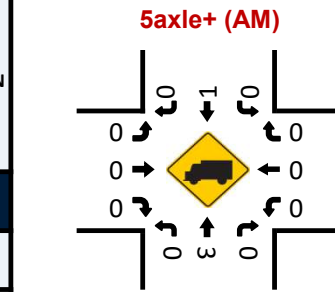
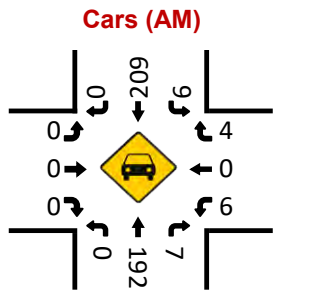
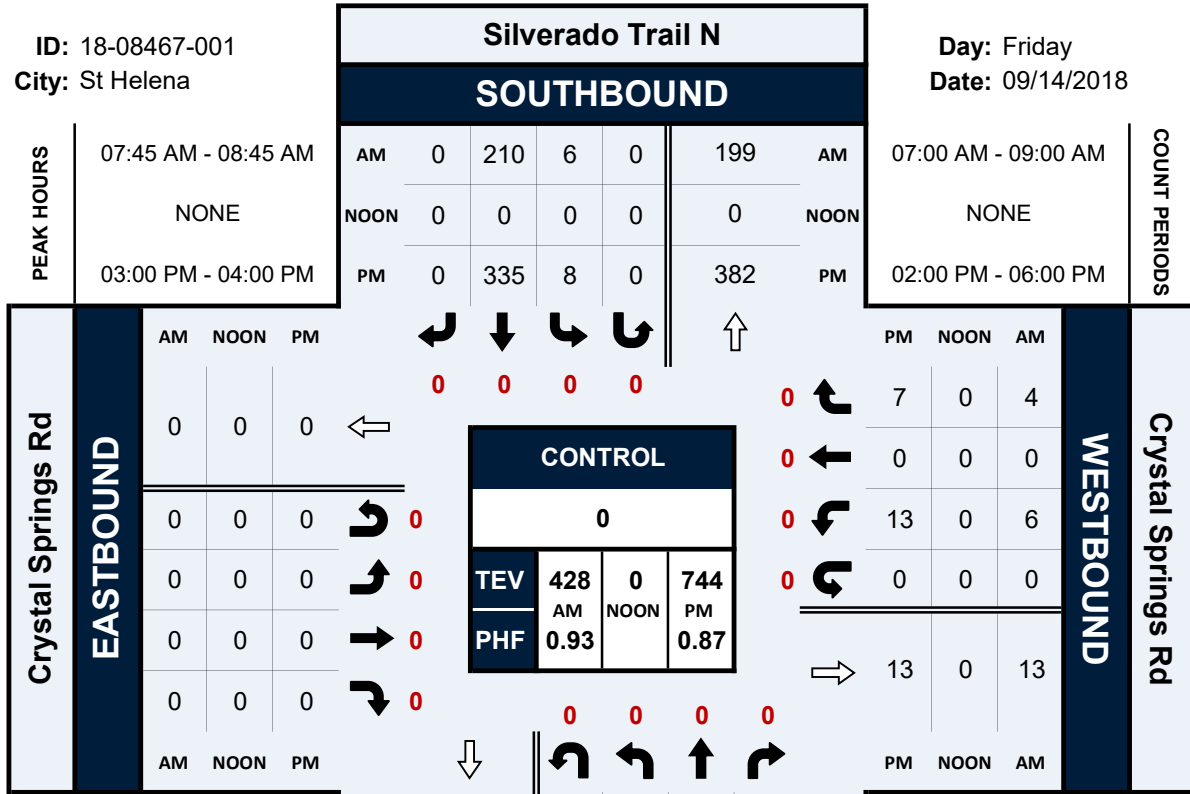

Silverado Trail N & Crystal Springs Rd

Peak Hour Turning Movement Count

ID: 18-08467-001
City: St Helena

Day: Saturday
Date: 09/15/2018

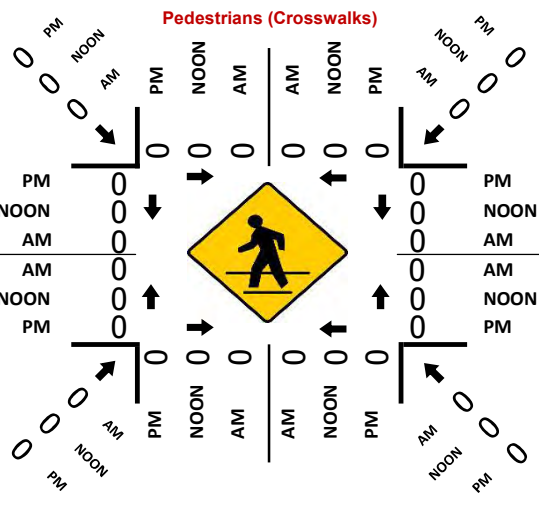
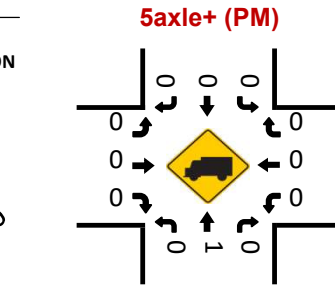
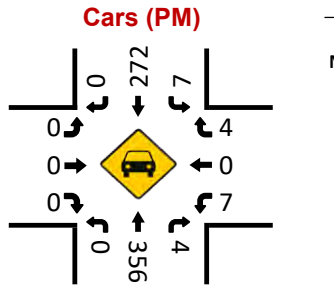
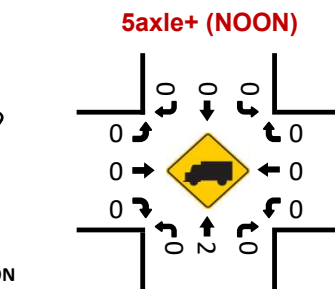
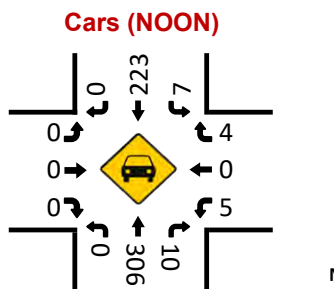
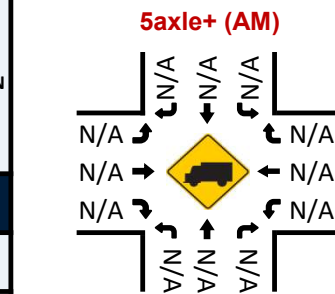
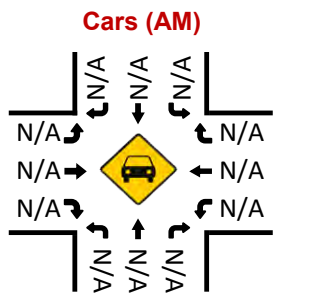
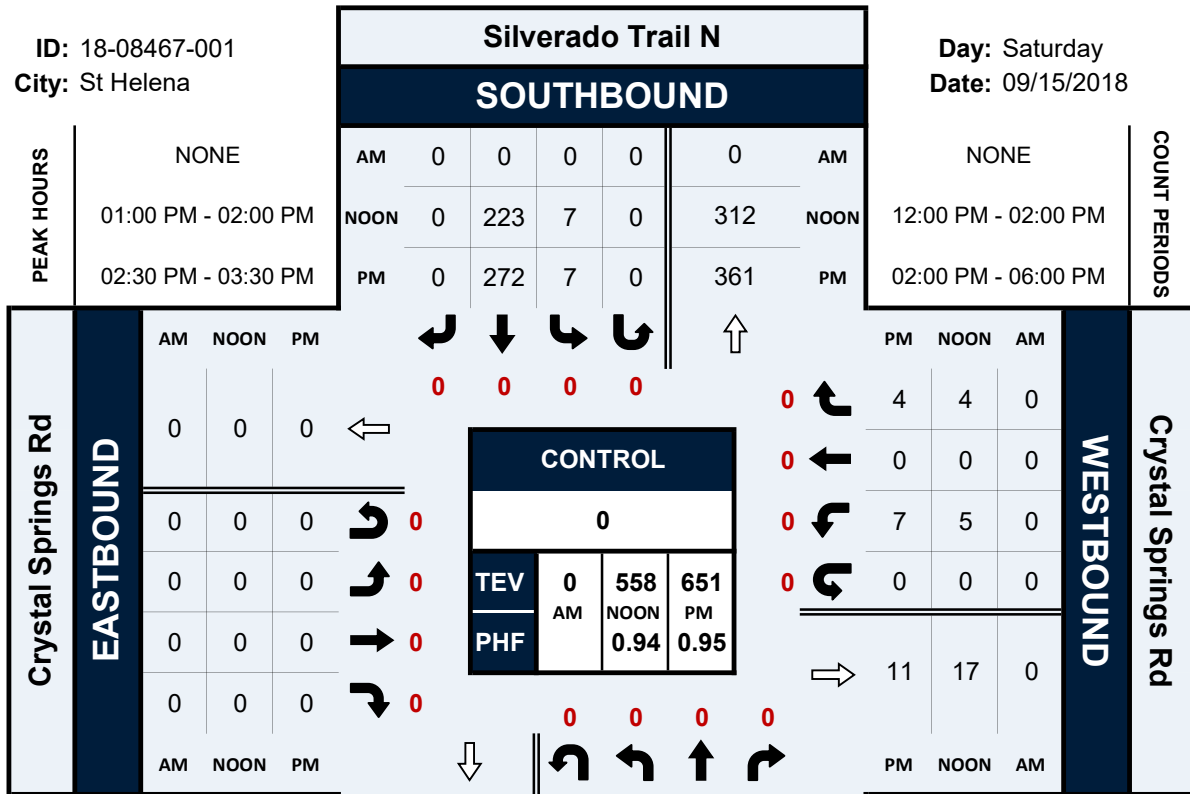

Crystal Springs Rd & 407 Crystal Springs Dwy

Peak Hour Turning Movement Count

ID: 18-08467-003
City: St Helena

Day: Friday
Date: 09/14/2018

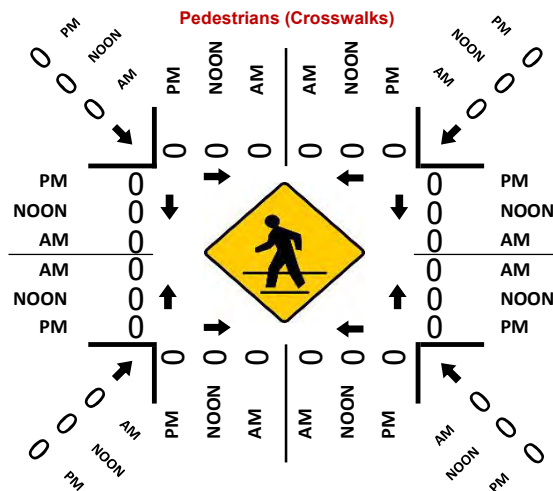
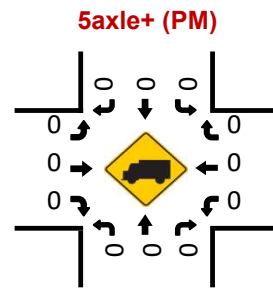
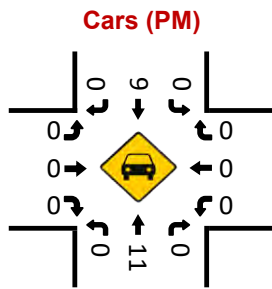
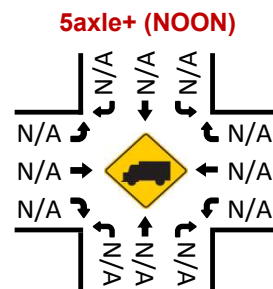
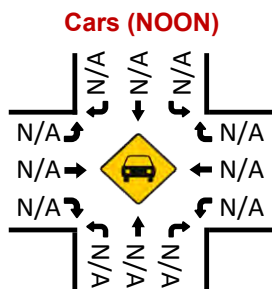
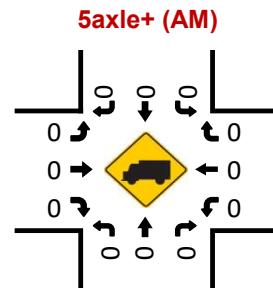
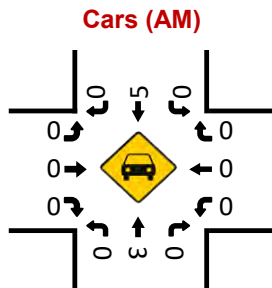
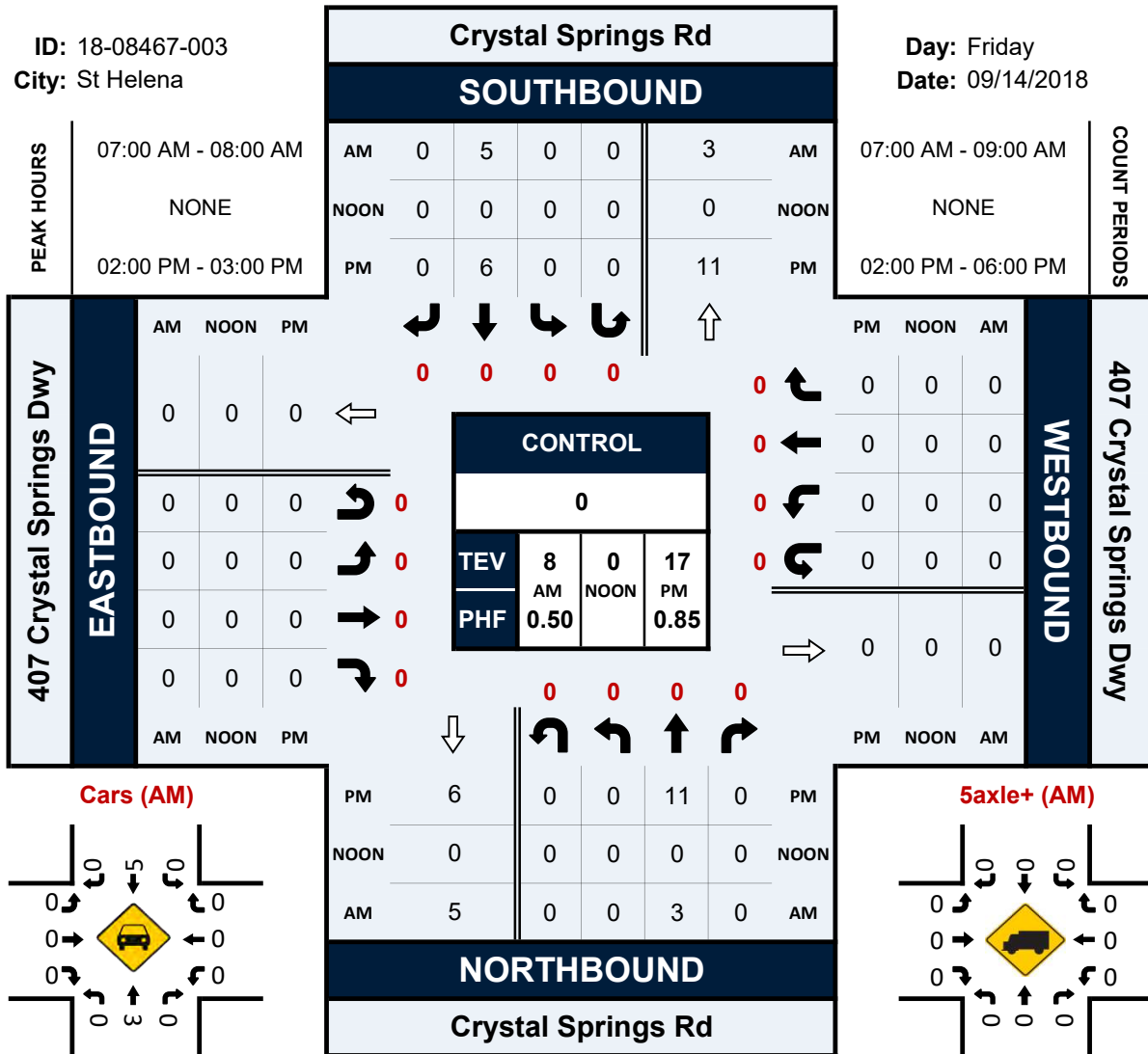

Crystal Springs Rd & 407 Crystal Springs Winery Dwy

Peak Hour Turning Movement Count

ID: 18-08467-003
City: St Helena

Day: Saturday
Date: 09/15/2018

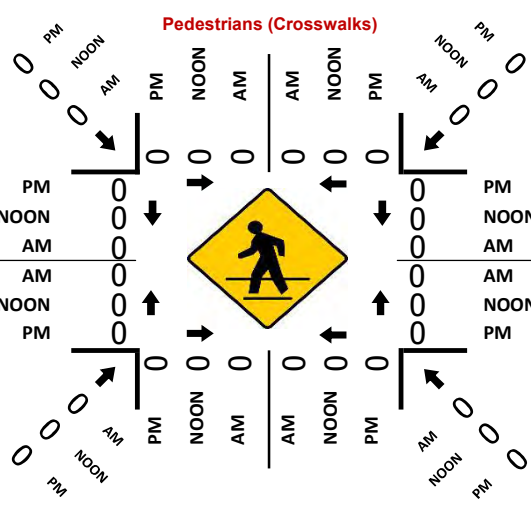
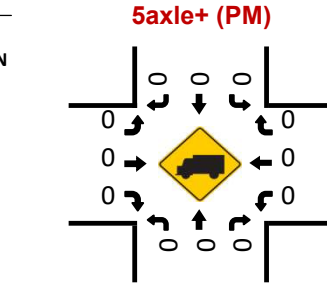
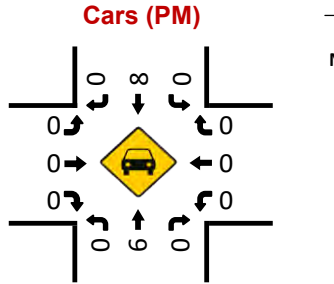
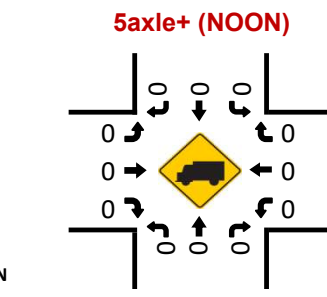
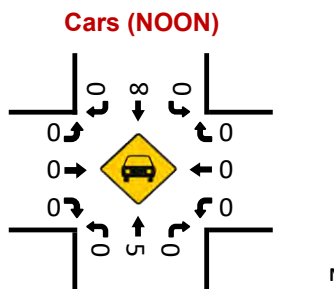
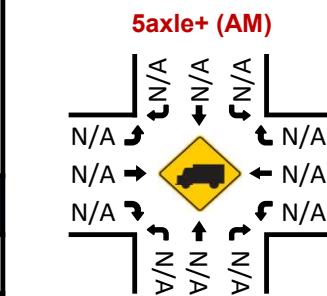
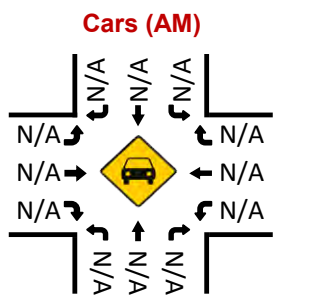
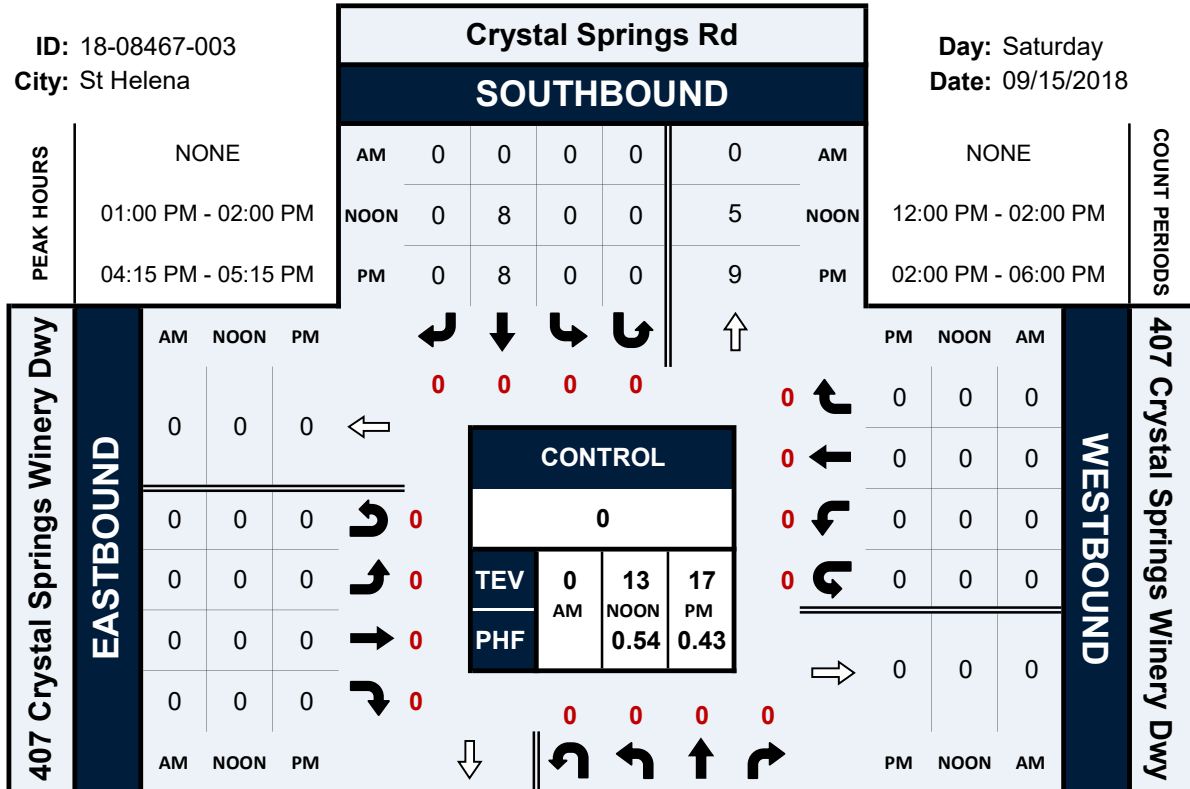

Silverado Trail N Deer Park Rd



Peak Hour

Date: 01-22-2021
Count Period: 2:00 PM to 6:00 PM
Peak Hour: 2:15 PM to 3:15 PM

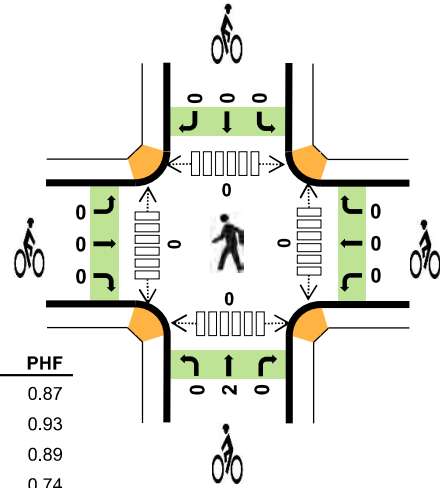
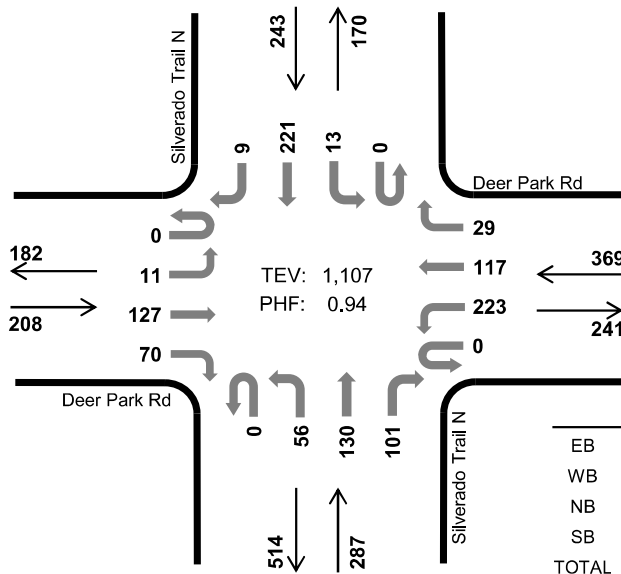

	HV %:	PHF
EB	1.4%	0.87
WB	3.0%	0.93
NB	5.6%	0.89
SB	6.2%	0.74
TOTAL	4.1%	0.94

Four-Hour Count Summaries

Interval Start	Deer Park Rd Eastbound				Deer Park Rd Westbound				Silverado Trail N Northbound				Silverado Trail N Southbound				15-min Total	Rolling One Hour	
	UT	LT	TH	RT	UT	LT	TH	RT	UT	LT	TH	RT	UT	LT	TH	RT			
2:15 PM	0	2	27	22	0	58	28	5	0	11	25	24	0	1	60	1	264	0	
2:30 PM	0	5	30	16	0	50	32	9	0	19	33	19	0	6	73	3	295	0	
2:45 PM	0	2	37	21	0	61	29	9	0	15	32	28	0	3	45	3	285	0	
3:00 PM	0	2	33	11	0	54	28	6	0	11	40	30	0	3	43	2	263	1,107	
Peak Hour	All	0	11	127	70	0	223	117	29	0	56	130	101	0	13	221	9	1,107	0
	HV	0	0	0	3	0	0	6	5	0	4	9	3	0	5	9	1	45	0
	HV%	-	0%	0%	4%	-	0%	5%	17%	-	7%	7%	3%	-	38%	4%	11%	4%	0

Note: For all three-hour count summary, see next page.

Interval Start	Heavy Vehicle Totals					Bicycles					Pedestrians (Crossing Leg)				
	EB	WB	NB	SB	Total	EB	WB	NB	SB	Total	East	West	North	South	Total
2:15 PM	2	6	3	5	16	0	0	0	0	0	0	0	0	0	0
2:30 PM	1	1	6	7	15	0	0	0	0	0	0	0	0	0	0
2:45 PM	0	3	4	0	7	0	0	0	0	0	0	0	0	0	0
3:00 PM	0	1	3	3	7	0	0	2	0	2	0	0	0	0	0
Peak Hour	3	11	16	15	45	0	0	2	0	2	0	0	0	0	0

Four-Hour Count Summaries																			
Interval Start	Deer Park Rd				Deer Park Rd				Silverado Trail N				Silverado Trail N				15-min Total	Rolling One Hour	
	Eastbound				Westbound				Northbound				Southbound						
	UT	LT	TH	RT	UT	LT	TH	RT	UT	LT	TH	RT	UT	LT	TH	RT			
2:00 PM	0	2	34	11	0	37	35	6	0	13	24	25	0	3	53	6	249	0	
2:15 PM	0	2	27	22	0	58	28	5	0	11	25	24	0	1	60	1	264	0	
2:30 PM	0	5	30	16	0	50	32	9	0	19	33	19	0	6	73	3	295	0	
2:45 PM	0	2	37	21	0	61	29	9	0	15	32	28	0	3	45	3	285	1,093	
3:00 PM	0	2	33	11	0	54	28	6	0	11	40	30	0	3	43	2	263	1,107	
3:15 PM	0	5	31	16	0	37	23	8	0	10	34	20	0	4	46	4	238	1,081	
3:30 PM	0	8	35	31	0	59	25	4	0	22	39	24	0	4	47	1	299	1,085	
3:45 PM	0	4	47	37	0	52	15	2	0	16	46	30	0	6	44	0	299	1,099	
4:00 PM	0	4	23	15	0	36	25	9	0	8	47	28	0	3	29	1	228	1,064	
4:15 PM	0	4	37	11	0	40	22	3	0	16	23	32	0	3	33	2	226	1,052	
4:30 PM	0	4	33	16	0	51	19	5	0	14	31	23	0	2	44	3	245	998	
4:45 PM	0	1	48	22	0	27	26	2	0	12	25	27	0	2	32	3	227	926	
5:00 PM	0	3	40	17	0	38	18	4	0	10	29	26	0	0	36	1	222	920	
5:15 PM	0	3	47	14	0	32	18	1	0	8	24	26	0	3	27	0	203	897	
5:30 PM	0	3	53	8	0	33	31	1	0	7	15	27	0	0	21	0	199	851	
5:45 PM	0	3	34	10	0	21	16	0	0	8	11	23	0	2	17	1	146	770	
Count Total	0	55	589	278	0	686	390	74	0	200	478	412	0	45	650	31	3,888	0	
Peak Hour	All	0	11	127	70	0	223	117	29	0	56	130	101	0	13	221	9	1,107	0
	HV	0	0	0	3	0	0	6	5	0	4	9	3	0	5	9	1	45	0
	HV%	-	0%	0%	4%	-	0%	5%	17%	-	7%	7%	3%	-	38%	4%	11%	4%	0
Note: Four-hour count summary volumes include heavy vehicles but exclude bicycles in overall count.																			
Interval Start	Heavy Vehicle Totals					Bicycles					Pedestrians (Crossing Leg)								
	EB	WB	NB	SB	Total	EB	WB	NB	SB	Total	East	West	North	South	Total				
2:00 PM	1	2	4	3	10	0	0	0	0	0	0	0	0	0	0				
2:15 PM	2	6	3	5	16	0	0	0	0	0	0	0	0	0	0				
2:30 PM	1	1	6	7	15	0	0	0	0	0	0	0	0	0	0				
2:45 PM	0	3	4	0	7	0	0	0	0	0	0	0	0	0	0				
3:00 PM	0	1	3	3	7	0	0	2	0	2	0	0	0	0	0				
3:15 PM	0	2	0	6	8	0	0	0	0	0	0	0	0	0	0				
3:30 PM	0	2	1	4	7	0	0	0	0	0	0	0	0	0	0				
3:45 PM	0	1	0	3	4	0	0	0	0	0	0	0	0	0	0				
4:00 PM	1	5	0	2	8	0	0	0	0	0	0	0	0	0	0				
4:15 PM	1	7	0	1	9	0	0	0	0	0	0	0	0	0	0				
4:30 PM	2	7	0	5	14	0	0	0	0	0	0	0	0	0	0				
4:45 PM	3	3	0	3	9	0	0	0	0	0	0	0	0	0	0				
5:00 PM	0	3	1	1	5	0	0	0	0	0	0	0	0	0	0				
5:15 PM	0	0	0	1	1	0	0	0	0	0	0	0	0	0	0				
5:30 PM	0	0	0	1	1	0	0	0	0	0	0	0	0	0	0				
5:45 PM	1	0	0	0	1	0	0	0	0	0	0	0	0	0	0				
Count Total	12	43	22	45	122	0	0	2	0	2	0	0	0	0	0				
Peak Hour	3	11	16	15	45	0	0	2	0	2	0	0	0	0	0				

Silverado Trail N Deer Park Rd



Peak Hour

Date: 01-23-2021
Count Period: 12:00 PM to 6:00 PM
Peak Hour: 1:30 PM to 2:30 PM

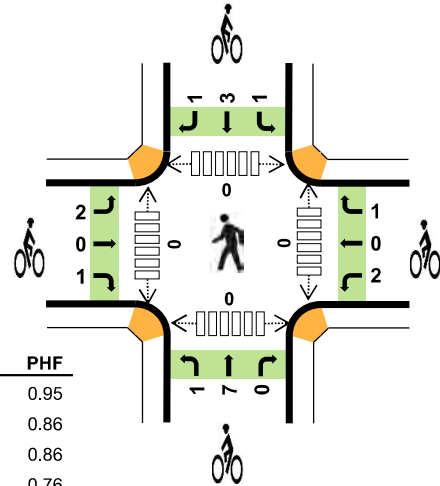
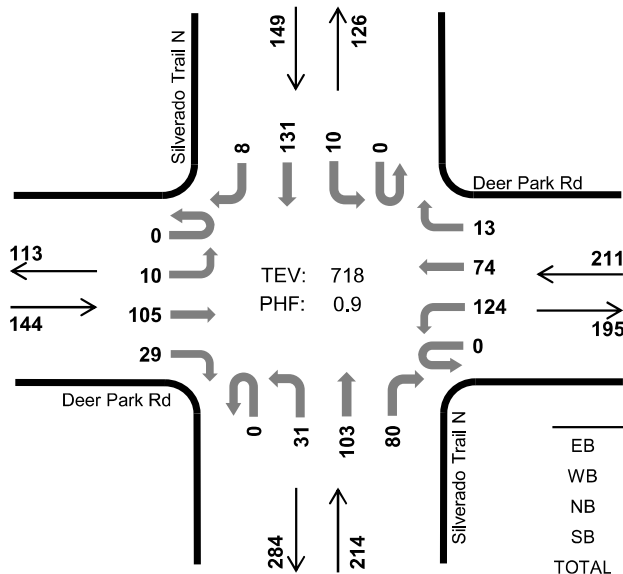

	HV %:	PHF
EB	1.4%	0.95
WB	2.4%	0.86
NB	1.4%	0.86
SB	2.7%	0.76
TOTAL	1.9%	0.90

Six-Hour Count Summaries

Interval Start	Deer Park Rd Eastbound				Deer Park Rd Westbound				Silverado Trail N Northbound				Silverado Trail N Southbound				15-min Total	Rolling One Hour	
	UT	LT	TH	RT	UT	LT	TH	RT	UT	LT	TH	RT	UT	LT	TH	RT			
1:30 PM	0	4	22	10	0	36	17	2	0	9	32	21	0	1	30	3	187	0	
1:45 PM	0	1	28	5	0	36	18	6	0	6	20	17	0	5	23	2	167	0	
2:00 PM	0	0	27	11	0	20	13	2	0	7	23	26	0	4	32	0	165	0	
2:15 PM	0	5	28	3	0	32	26	3	0	9	28	16	0	0	46	3	199	718	
Peak Hour	All	0	10	105	29	0	124	74	13	0	31	103	80	0	10	131	8	718	0
	HV	0	1	0	1	0	1	3	1	0	0	3	0	0	1	3	0	14	0
	HV%	-	10%	0%	3%	-	1%	4%	8%	-	0%	3%	0%	-	10%	2%	0%	2%	0

Note: For all three-hour count summary, see next page.

Interval Start	Heavy Vehicle Totals					Bicycles					Pedestrians (Crossing Leg)				
	EB	WB	NB	SB	Total	EB	WB	NB	SB	Total	East	West	North	South	Total
1:30 PM	0	0	1	0	1	1	0	0	0	1	0	0	0	0	0
1:45 PM	0	2	0	1	3	0	3	0	2	5	0	0	0	0	0
2:00 PM	1	0	1	2	4	2	0	6	2	10	0	0	0	0	0
2:15 PM	1	3	1	1	6	0	0	2	1	3	0	0	0	0	0
Peak Hour	2	5	3	4	14	3	3	8	5	19	0	0	0	0	0

Six-Hour Count Summaries																			
Interval Start	Deer Park Rd				Deer Park Rd				Silverado Trail N				Silverado Trail N				15-min Total	Rolling One Hour	
	Eastbound				Westbound				Northbound				Southbound						
	UT	LT	TH	RT	UT	LT	TH	RT	UT	LT	TH	RT	UT	LT	TH	RT			
12:00 PM	0	4	29	18	0	22	15	7	0	5	25	13	0	3	41	5	187	0	
12:15 PM	0	4	20	5	0	31	21	6	0	8	26	16	0	2	23	2	164	0	
12:30 PM	0	1	10	7	0	27	38	6	0	10	30	15	0	5	25	1	175	0	
12:45 PM	0	4	24	8	0	35	26	15	0	8	27	18	0	4	17	2	188	714	
1:00 PM	0	7	24	8	0	24	22	4	0	8	24	19	0	1	27	2	170	697	
1:15 PM	0	1	27	5	0	32	28	7	0	5	21	13	0	2	23	4	168	701	
1:30 PM	0	4	22	10	0	36	17	2	0	9	32	21	0	1	30	3	187	713	
1:45 PM	0	1	28	5	0	36	18	6	0	6	20	17	0	5	23	2	167	692	
2:00 PM	0	0	27	11	0	20	13	2	0	7	23	26	0	4	32	0	165	687	
2:15 PM	0	5	28	3	0	32	26	3	0	9	28	16	0	0	46	3	199	718	
2:30 PM	0	3	18	9	0	28	24	3	0	3	25	12	0	6	29	6	166	697	
2:45 PM	0	2	25	6	0	25	19	3	0	9	20	12	0	0	43	6	170	700	
3:00 PM	0	3	26	4	0	39	19	4	0	8	21	13	0	2	26	3	168	703	
3:15 PM	0	4	13	7	0	19	14	3	0	10	29	18	0	2	41	4	164	668	
3:30 PM	0	3	23	6	0	27	19	3	0	8	25	16	0	2	39	1	172	674	
3:45 PM	0	4	24	8	0	31	17	0	0	6	17	17	0	2	25	1	152	656	
4:00 PM	0	2	28	9	0	25	19	4	0	6	25	18	0	2	27	4	169	657	
4:15 PM	0	2	24	13	0	19	15	5	0	12	20	16	0	0	29	2	157	650	
4:30 PM	0	0	19	9	0	18	11	4	0	7	27	15	0	2	33	3	148	626	
4:45 PM	0	4	28	7	0	39	14	4	0	7	19	13	0	0	27	1	163	637	
5:00 PM	0	0	22	5	0	25	20	4	0	2	24	14	0	0	29	3	148	616	
5:15 PM	0	0	25	8	0	23	19	2	0	4	12	16	0	1	20	4	134	593	
5:30 PM	0	3	19	3	0	14	13	2	0	5	13	14	0	3	24	2	115	560	
5:45 PM	0	2	23	2	0	23	14	1	0	5	5	17	0	1	18	3	114	511	
Count Total	0	63	556	176	0	650	461	100	0	167	538	385	0	50	697	67	3,910	0	
Peak Hour	All	0	10	105	29	0	124	74	13	0	31	103	80	0	10	131	8	718	0
	HV	0	1	0	1	0	1	3	1	0	0	3	0	0	1	3	0	14	0
	HV%	-	10%	0%	3%	-	1%	4%	8%	-	0%	3%	0%	-	10%	2%	0%	2%	0
Note: Six-hour count summary volumes include heavy vehicles but exclude bicycles in overall count.																			
Interval Start	Heavy Vehicle Totals					Bicycles					Pedestrians (Crossing Leg)								
	EB	WB	NB	SB	Total	EB	WB	NB	SB	Total	East	West	North	South	Total				
12:00 PM	4	1	1	3	9	1	0	0	3	4	0	0	0	0	0				
12:15 PM	2	4	3	2	11	0	0	8	2	10	0	0	0	0	0				
12:30 PM	0	0	1	0	1	0	2	1	10	13	0	0	0	0	0				
12:45 PM	0	2	2	1	5	2	1	2	2	7	0	0	0	0	0				
1:00 PM	0	1	3	0	4	0	0	4	2	6	0	0	0	0	0				
1:15 PM	0	0	0	2	2	1	0	1	0	2	0	0	0	0	0				
1:30 PM	0	0	1	0	1	1	0	0	0	1	0	0	0	0	0				
1:45 PM	0	2	0	1	3	0	3	0	2	5	0	0	0	0	0				
2:00 PM	1	0	1	2	4	2	0	6	2	10	0	0	0	0	0				
2:15 PM	1	3	1	1	6	0	0	2	1	3	0	0	0	0	0				
2:30 PM	0	1	0	1	2	0	1	7	3	11	0	0	0	0	0				
2:45 PM	0	0	0	1	1	3	0	2	9	14	0	0	0	0	0				
3:00 PM	1	0	1	0	2	0	0	1	2	3	0	0	0	0	0				
3:15 PM	0	0	0	2	2	1	1	3	0	5	0	0	0	0	0				
3:30 PM	0	0	1	0	1	1	0	2	3	6	0	0	0	0	0				
3:45 PM	0	1	1	0	2	0	0	0	2	2	0	0	0	0	0				
4:00 PM	0	1	0	1	2	0	0	0	1	1	0	0	0	0	0				
4:15 PM	1	2	0	1	4	0	0	0	0	0	0	0	0	0	0				
4:30 PM	0	0	1	0	1	0	1	1	0	2	0	0	0	0	0				
4:45 PM	0	0	0	1	1	0	1	1	1	3	0	0	0	0	0				
5:00 PM	0	1	2	0	3	0	0	0	0	0	0	0	0	0	0				
5:15 PM	0	0	0	1	1	0	2	0	0	2	0	0	0	0	0				
5:30 PM	0	0	0	0	0	0	0	0	0	0	0	0	0	0	0				
5:45 PM	0	0	0	0	0	0	0	0	0	0	0	0	0	0	0				
Count Total	10	19	19	20	68	12	12	41	45	110	0	0	0	0	0				
Peak Hour	2	5	3	4	14	3	3	8	5	19	0	0	0	0	0				

Sanitarium Rd Crystal Springs Rd



Date: 01-22-2021

Count Period: 2:00 PM to 6:00 PM

Peak Hour: 2:15 PM to 3:15 PM

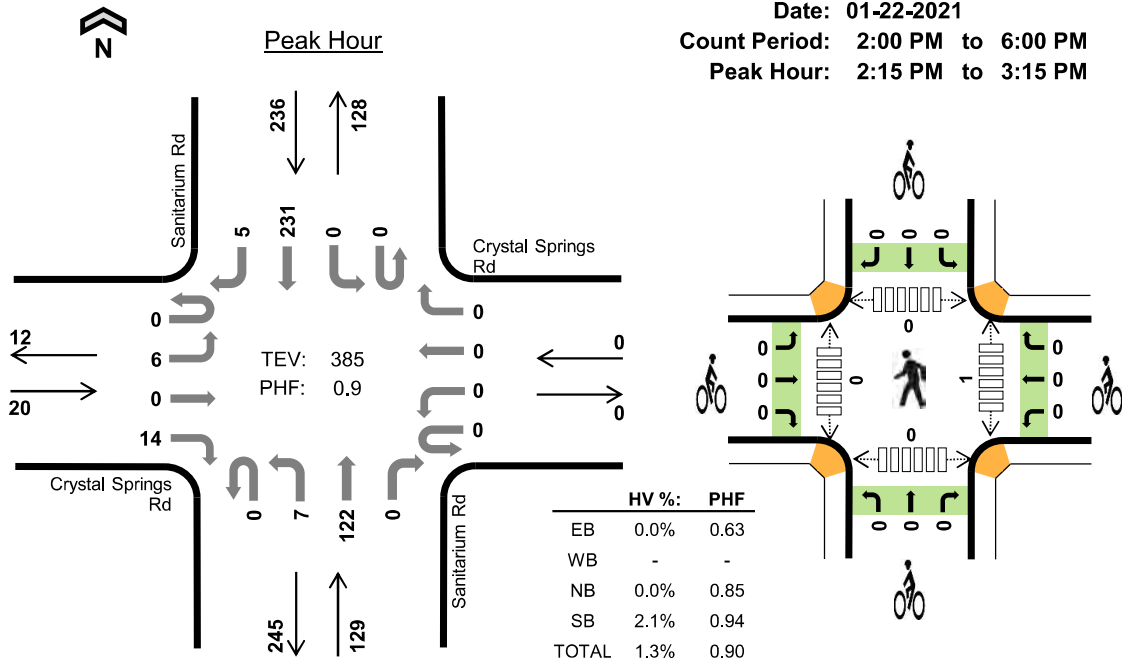

Four-Hour Count Summaries

Interval Start	Crystal Springs Rd Eastbound				Crystal Springs Rd Westbound				Sanitarium Rd Northbound				Sanitarium Rd Southbound				15-min Total	Rolling One Hour	
	UT	LT	TH	RT	UT	LT	TH	RT	UT	LT	TH	RT	UT	LT	TH	RT			
2:15 PM	0	3	0	3	0	0	0	0	0	5	33	0	0	0	61	2	107	0	
2:30 PM	0	1	0	7	0	0	0	0	0	0	28	0	0	0	53	3	92	0	
2:45 PM	0	1	0	2	0	0	0	0	0	2	26	0	0	0	62	0	93	0	
3:00 PM	0	1	0	2	0	0	0	0	0	0	35	0	0	0	55	0	93	385	
Peak Hour	All	0	6	0	14	0	0	0	0	0	7	122	0	0	0	231	5	385	0
	HV	0	0	0	0	0	0	0	0	0	0	0	0	0	0	5	0	5	0
	HV%	-	0%	-	0%	-	-	-	-	-	0%	0%	-	-	-	2%	0%	1%	0

Note: For all three-hour count summary, see next page.

Interval Start	Heavy Vehicle Totals					Bicycles					Pedestrians (Crossing Leg)				
	EB	WB	NB	SB	Total	EB	WB	NB	SB	Total	East	West	North	South	Total
2:15 PM	0	0	0	1	1	0	0	0	0	0	1	0	0	0	1
2:30 PM	0	0	0	0	0	0	0	0	0	0	0	0	0	0	0
2:45 PM	0	0	0	1	1	0	0	0	0	0	0	0	0	0	0
3:00 PM	0	0	0	3	3	0	0	0	0	0	0	0	0	0	0
Peak Hour	0	0	0	5	5	0	0	0	0	0	1	0	0	0	1

Four-Hour Count Summaries																			
Interval Start	Crystal Springs Rd				Crystal Springs Rd				Sanitarium Rd				Sanitarium Rd				15-min Total	Rolling One Hour	
	Eastbound				Westbound				Northbound				Southbound						
	UT	LT	TH	RT	UT	LT	TH	RT	UT	LT	TH	RT	UT	LT	TH	RT			
2:00 PM	0	0	0	6	0	0	0	0	0	4	29	0	0	0	45	0	84	0	
2:15 PM	0	3	0	3	0	0	0	0	0	5	33	0	0	0	61	2	107	0	
2:30 PM	0	1	0	7	0	0	0	0	0	0	28	0	0	0	53	3	92	0	
2:45 PM	0	1	0	2	0	0	0	0	0	2	26	0	0	0	62	0	93	376	
3:00 PM	0	1	0	2	0	0	0	0	0	0	35	0	0	0	55	0	93	385	
3:15 PM	0	0	0	3	0	0	0	0	0	2	21	0	0	0	40	0	66	344	
3:30 PM	0	2	0	4	0	0	0	0	0	2	27	0	0	0	50	0	85	337	
3:45 PM	0	0	0	3	0	0	0	0	0	5	26	0	0	0	33	1	68	312	
4:00 PM	0	3	0	1	0	0	0	0	0	3	24	0	0	0	28	1	60	279	
4:15 PM	0	0	0	2	0	0	0	0	0	3	27	0	0	0	42	3	77	290	
4:30 PM	0	2	0	2	0	0	0	0	0	1	29	0	0	0	48	1	83	288	
4:45 PM	0	1	0	4	0	0	0	0	0	1	29	0	0	0	24	2	61	281	
5:00 PM	0	0	0	2	0	0	0	0	0	1	22	0	0	0	28	0	53	274	
5:15 PM	0	0	0	4	0	0	0	0	0	0	29	0	0	0	32	2	67	264	
5:30 PM	0	2	0	4	0	0	0	0	0	4	37	0	0	0	28	0	75	256	
5:45 PM	0	1	0	2	0	0	0	0	0	3	22	0	0	0	29	1	58	253	
Count Total	0	17	0	51	0	0	0	0	0	36	444	0	0	0	658	16	1,222	0	
Peak Hour	All	0	6	0	14	0	0	0	0	0	7	122	0	0	0	231	5	385	0
	HV	0	0	0	0	0	0	0	0	0	0	0	0	0	0	5	0	5	0
	HV%	-	0%	-	0%	-	-	-	-	-	-	0%	0%	-	-	-	2%	0%	1%
Note: Four-hour count summary volumes include heavy vehicles but exclude bicycles in overall count.																			
Interval Start	Heavy Vehicle Totals					Bicycles					Pedestrians (Crossing Leg)								
	EB	WB	NB	SB	Total	EB	WB	NB	SB	Total	East	West	North	South	Total				
2:00 PM	0	0	1	0	1	0	0	0	0	0	0	0	0	0	0	0	0	0	0
2:15 PM	0	0	0	1	1	0	0	0	0	0	1	0	0	0	0	0	0	0	1
2:30 PM	0	0	0	0	0	0	0	0	0	0	0	0	0	0	0	0	0	0	0
2:45 PM	0	0	0	1	1	0	0	0	0	0	0	0	0	0	0	0	0	0	0
3:00 PM	0	0	0	3	3	0	0	0	0	0	0	0	0	0	0	0	0	0	0
3:15 PM	0	0	0	1	1	0	0	0	0	0	0	0	0	0	0	0	0	0	0
3:30 PM	0	0	1	0	1	0	0	0	0	0	0	0	0	0	0	0	0	0	0
3:45 PM	0	0	0	0	0	0	0	0	0	0	0	0	0	0	0	0	0	0	0
4:00 PM	0	0	0	0	0	0	0	0	0	0	0	0	0	0	0	0	0	0	0
4:15 PM	0	0	1	1	2	0	0	0	0	0	0	0	0	0	0	0	0	0	0
4:30 PM	1	0	0	6	7	0	0	0	0	0	0	0	0	0	0	0	0	0	0
4:45 PM	1	0	0	0	1	1	0	0	0	1	0	0	0	0	0	0	0	0	0
5:00 PM	1	0	0	0	1	0	0	0	0	0	0	0	0	0	0	0	0	0	0
5:15 PM	0	0	0	0	0	0	0	0	0	0	0	0	0	0	0	0	0	0	0
5:30 PM	0	0	0	0	0	0	0	0	0	0	0	0	0	0	0	0	0	0	0
5:45 PM	0	0	0	0	0	0	0	0	0	0	0	0	0	0	0	0	0	0	0
Count Total	3	0	3	13	19	1	0	0	0	1	1	0	0	0	0	0	1	0	1
Peak Hour	0	0	0	5	5	0	0	0	0	0	1	0	0	0	0	0	1	0	1

Sanitarium Rd Crystal Springs Rd



Date: 01-23-2021
Count Period: 12:00 PM to 6:00 PM
Peak Hour: 12:15 PM to 1:15 PM

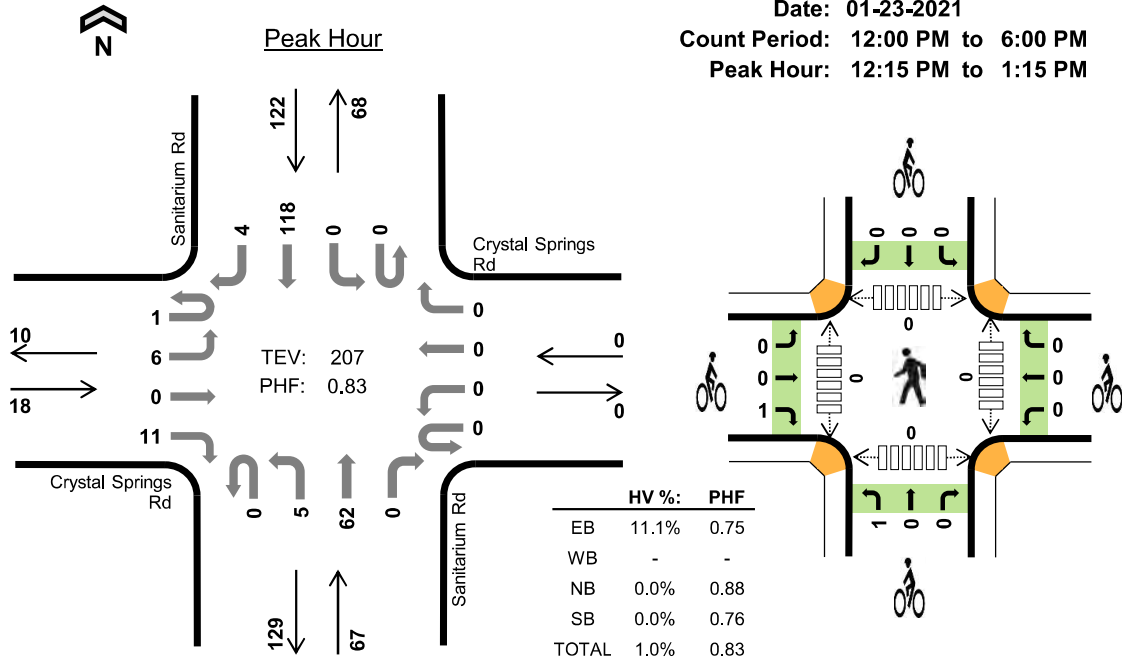

Six-Hour Count Summaries

Interval Start	Crystal Springs Rd Eastbound				Crystal Springs Rd Westbound				Sanitarium Rd Northbound				Sanitarium Rd Southbound				15-min Total	Rolling One Hour	
	UT	LT	TH	RT	UT	LT	TH	RT	UT	LT	TH	RT	UT	LT	TH	RT			
12:15 PM	0	0	0	3	0	0	0	0	0	2	17	0	0	0	39	1	62	0	
12:30 PM	1	1	0	2	0	0	0	0	0	1	15	0	0	0	28	1	49	0	
12:45 PM	0	2	0	4	0	0	0	0	0	2	16	0	0	0	27	0	51	0	
1:00 PM	0	3	0	2	0	0	0	0	0	0	14	0	0	0	24	2	45	207	
Peak Hour	All	1	6	0	11	0	0	0	0	0	5	62	0	0	0	118	4	207	0
	HV	0	0	0	2	0	0	0	0	0	0	0	0	0	0	0	0	2	0
	HV%	0%	0%	-	18%	-	-	-	-	-	0%	0%	-	-	-	0%	0%	1%	0

Note: For all three-hour count summary, see next page.

Interval Start	Heavy Vehicle Totals					Bicycles					Pedestrians (Crossing Leg)				
	EB	WB	NB	SB	Total	EB	WB	NB	SB	Total	East	West	North	South	Total
12:15 PM	1	0	0	0	1	0	0	0	0	0	0	0	0	0	0
12:30 PM	0	0	0	0	0	1	0	1	0	2	0	0	0	0	0
12:45 PM	1	0	0	0	1	0	0	0	0	0	0	0	0	0	0
1:00 PM	0	0	0	0	0	0	0	0	0	0	0	0	0	0	0
Peak Hour	2	0	0	0	2	1	0	1	0	2	0	0	0	0	0

Six-Hour Count Summaries																			
Interval Start	Crystal Springs Rd				Crystal Springs Rd				Sanitarium Rd				Sanitarium Rd				15-min Total	Rolling One Hour	
	Eastbound				Westbound				Northbound				Southbound						
	UT	LT	TH	RT	UT	LT	TH	RT	UT	LT	TH	RT	UT	LT	TH	RT			
12:00 PM	0	0	0	1	0	0	0	0	0	1	18	0	0	0	18	0	38	0	
12:15 PM	0	0	0	3	0	0	0	0	0	2	17	0	0	0	39	1	62	0	
12:30 PM	1	1	0	2	0	0	0	0	0	1	15	0	0	0	28	1	49	0	
12:45 PM	0	2	0	4	0	0	0	0	0	2	16	0	0	0	27	0	51	200	
1:00 PM	0	3	0	2	0	0	0	0	0	0	14	0	0	0	24	2	45	207	
1:15 PM	0	1	0	4	0	0	0	0	0	1	18	0	0	0	20	1	45	190	
1:30 PM	0	1	0	2	0	0	0	0	0	1	22	0	0	0	23	0	49	190	
1:45 PM	0	4	0	0	0	0	0	0	0	3	19	0	0	0	30	1	57	196	
2:00 PM	0	0	0	4	0	0	0	0	0	0	20	0	0	0	14	2	40	191	
2:15 PM	0	0	0	1	0	0	0	0	0	1	28	0	0	0	18	0	48	194	
2:30 PM	0	2	0	4	0	0	0	0	0	3	14	0	0	0	20	1	44	189	
2:45 PM	0	1	0	0	0	0	0	0	1	4	14	0	0	0	21	0	41	173	
3:00 PM	0	1	0	1	0	0	0	0	0	1	18	0	0	0	32	1	54	187	
3:15 PM	0	1	0	1	0	0	0	0	0	1	13	0	0	0	12	1	29	168	
3:30 PM	0	0	0	3	0	0	0	0	0	2	12	0	0	0	18	0	35	159	
3:45 PM	0	2	0	0	0	0	0	0	0	1	16	0	0	0	18	1	38	156	
4:00 PM	0	1	0	2	0	0	0	0	0	2	20	0	0	0	21	0	46	148	
4:15 PM	0	1	0	1	0	0	0	0	0	2	10	0	0	0	11	0	25	144	
4:30 PM	0	1	0	1	0	0	0	0	0	0	14	0	0	0	19	0	35	144	
4:45 PM	0	1	0	1	0	0	0	0	0	1	21	0	0	0	17	0	41	147	
5:00 PM	0	1	0	1	0	0	0	0	0	6	23	0	0	0	22	1	54	155	
5:15 PM	0	0	0	1	0	0	0	0	0	2	11	0	0	0	17	1	32	162	
5:30 PM	0	2	0	1	0	0	0	0	0	0	16	0	0	0	11	0	30	157	
5:45 PM	0	0	0	2	0	0	0	0	0	0	20	0	0	0	20	0	42	158	
Count Total	1	26	0	42	0	0	0	0	1	37	409	0	0	0	500	14	1,030	0	
Peak Hour	All	1	6	0	11	0	0	0	0	0	5	62	0	0	0	118	4	207	0
	HV	0	0	0	2	0	0	0	0	0	0	0	0	0	0	0	0	2	0
	HV%	0%	0%	-	18%	-	-	-	-	-	0%	0%	-	-	-	0%	0%	1%	0

Note: Six-hour count summary volumes include heavy vehicles but exclude bicycles in overall count.

Interval Start	Heavy Vehicle Totals					Bicycles					Pedestrians (Crossing Leg)				
	EB	WB	NB	SB	Total	EB	WB	NB	SB	Total	East	West	North	South	Total
12:00 PM	0	0	0	0	0	0	0	0	0	0	0	0	0	0	0
12:15 PM	1	0	0	0	1	0	0	0	0	0	0	0	0	0	0
12:30 PM	0	0	0	0	0	1	0	1	0	2	0	0	0	0	0
12:45 PM	1	0	0	0	1	0	0	0	0	0	0	0	0	0	0
1:00 PM	0	0	0	0	0	0	0	0	0	0	0	0	0	0	0
1:15 PM	0	0	0	0	0	0	0	0	0	0	0	0	0	0	0
1:30 PM	0	0	0	0	0	0	0	0	1	1	0	0	0	0	0
1:45 PM	0	0	0	0	0	0	0	0	0	0	0	0	0	0	0
2:00 PM	0	0	0	0	0	0	0	1	0	1	0	0	0	0	0
2:15 PM	0	0	0	0	0	0	0	1	1	2	0	0	0	0	0
2:30 PM	0	0	0	0	0	1	0	0	0	1	0	0	0	0	0
2:45 PM	0	0	0	0	0	0	0	2	0	2	0	0	0	0	0
3:00 PM	0	0	0	0	0	0	0	0	0	0	0	0	0	0	0
3:15 PM	0	0	0	0	0	0	0	1	0	1	0	0	0	0	0
3:30 PM	0	0	0	0	0	0	0	0	0	0	0	0	0	0	0
3:45 PM	0	0	0	0	0	0	0	0	0	0	0	0	0	0	0
4:00 PM	0	0	0	0	0	0	0	0	0	0	0	0	0	0	0
4:15 PM	0	0	0	0	0	1	0	0	0	1	0	0	0	0	0
4:30 PM	0	0	0	0	0	0	0	0	1	1	0	0	0	0	0
4:45 PM	0	0	0	0	0	0	0	0	1	1	0	0	0	0	0
5:00 PM	0	0	0	0	0	0	0	0	0	0	0	0	0	0	0
5:15 PM	0	0	0	0	0	0	0	0	0	0	0	0	0	0	0
5:30 PM	0	0	0	0	0	0	0	0	0	0	0	0	0	0	0
5:45 PM	0	0	0	0	0	0	0	0	0	0	0	0	0	0	0
Count Total	2	0	0	0	2	3	0	6	4	13	0	0	0	0	0
Peak Hour	2	0	0	0	2	1	0	1	0	2	0	0	0	0	0

Sanitarium Rd Deer Park Rd



Date: 01-22-2021
 Count Period: 2:00 PM to 6:00 PM
 Peak Hour: 2:15 PM to 3:15 PM

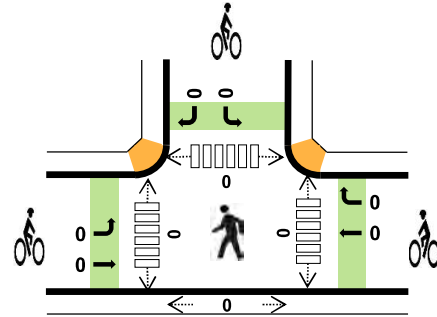
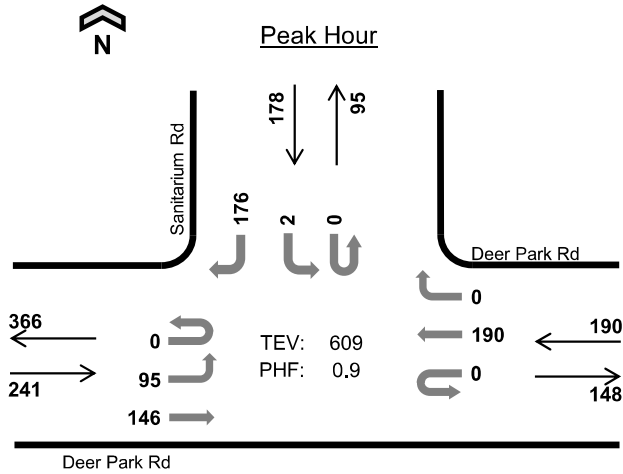

	HV %:	PHF
EB	3.3%	0.90
WB	5.3%	0.83
NB	-	-
SB	1.1%	0.99
TOTAL	3.3%	0.90

Four-Hour Count Summaries

Interval Start	Deer Park Rd Eastbound				Deer Park Rd Westbound				n/a Northbound				Sanitarium Rd Southbound				15-min Total	Rolling One Hour
	UT	LT	TH	RT	UT	LT	TH	RT	UT	LT	TH	RT	UT	LT	TH	RT		
2:15 PM	0	27	28	0	0	0	44	0	0	0	0	0	0	0	0	44	143	0
2:30 PM	0	16	38	0	0	0	46	0	0	0	0	0	0	0	0	45	145	0
2:45 PM	0	24	43	0	0	0	57	0	0	0	0	0	0	1	0	44	169	0
3:00 PM	0	28	37	0	0	0	43	0	0	0	0	0	0	1	0	43	152	609
Peak Hour	All	0	95	146	0	0	190	0	0	0	0	0	0	2	0	176	609	0
	HV	0	0	8	0	0	10	0	0	0	0	0	0	1	0	1	20	0
	HV%	-	0%	5%	-	-	5%	-	-	-	-	-	-	50%	-	1%	3%	0

Note: For all three-hour count summary, see next page.

Interval Start	Heavy Vehicle Totals					Bicycles					Pedestrians (Crossing Leg)				
	EB	WB	NB	SB	Total	EB	WB	NB	SB	Total	East	West	North	South	Total
2:15 PM	2	5	0	1	8	0	0	0	0	0	0	0	0	0	0
2:30 PM	3	1	0	0	4	0	0	0	0	0	0	0	0	0	0
2:45 PM	2	3	0	1	6	0	0	0	0	0	0	0	0	0	0
3:00 PM	1	1	0	0	2	0	0	0	0	0	0	0	0	0	0
Peak Hour	8	10	0	2	20	0	0	0	0	0	0	0	0	0	0

Four-Hour Count Summaries																		
Interval Start	Deer Park Rd				Deer Park Rd				n/a				Sanitarium Rd				15-min Total	Rolling One Hour
	Eastbound				Westbound				Northbound				Southbound					
	UT	LT	TH	RT	UT	LT	TH	RT	UT	LT	TH	RT	UT	LT	TH	RT		
2:00 PM	0	25	33	0	0	0	30	0	0	0	0	0	0	0	0	45	133	0
2:15 PM	0	27	28	0	0	0	44	0	0	0	0	0	0	0	0	44	143	0
2:30 PM	0	16	38	0	0	0	46	0	0	0	0	0	0	0	0	45	145	0
2:45 PM	0	24	43	0	0	0	57	0	0	0	0	0	1	0	0	44	169	590
3:00 PM	0	28	37	0	0	0	43	0	0	0	0	0	1	0	0	43	152	609
3:15 PM	0	19	37	0	0	0	38	0	0	0	0	0	0	0	0	31	125	591
3:30 PM	0	20	41	0	0	0	35	0	0	0	0	0	0	0	0	49	145	591
3:45 PM	0	26	58	0	0	0	42	0	0	0	0	0	0	0	0	27	153	575
4:00 PM	0	16	40	0	0	0	46	0	0	0	0	0	0	0	0	23	125	548
4:15 PM	0	29	42	0	0	0	32	0	0	0	0	0	0	0	0	32	135	558
4:30 PM	0	19	39	0	0	0	32	0	0	0	0	0	1	0	0	43	134	547
4:45 PM	0	23	50	0	0	0	39	1	0	0	0	0	0	0	0	19	132	526
5:00 PM	0	22	48	0	0	0	30	0	0	0	0	0	0	0	0	27	127	528
5:15 PM	0	25	49	0	0	0	21	0	0	0	0	0	0	0	0	29	124	517
5:30 PM	0	31	47	0	0	0	35	0	0	0	0	0	0	0	0	29	142	525
5:45 PM	0	19	42	0	0	0	14	0	0	0	0	0	0	0	0	21	96	489
Count Total	0	369	672	0	0	0	584	1	0	0	0	0	0	3	0	551	2,180	0
Peak Hour	All	0	95	146	0	0	0	190	0	0	0	0	0	2	0	176	609	0
	HV	0	0	8	0	0	0	10	0	0	0	0	0	1	0	1	20	0
	HV%	-	0%	5%	-	-	-	5%	-	-	-	-	-	50%	-	1%	3%	0
Note: Four-hour count summary volumes include heavy vehicles but exclude bicycles in overall count.																		
Interval Start	Heavy Vehicle Totals					Bicycles					Pedestrians (Crossing Leg)							
	EB	WB	NB	SB	Total	EB	WB	NB	SB	Total	East	West	North	South	Total			
2:00 PM	4	1	0	1	6	0	0	0	0	0	0	0	0	0	0	0	0	
2:15 PM	2	5	0	1	8	0	0	0	0	0	0	0	0	0	0	0	0	
2:30 PM	3	1	0	0	4	0	0	0	0	0	0	0	0	0	0	0	0	
2:45 PM	2	3	0	1	6	0	0	0	0	0	0	0	0	0	0	0	0	
3:00 PM	1	1	0	0	2	0	0	0	0	0	0	0	0	0	0	0	0	
3:15 PM	1	1	0	1	3	0	0	0	0	0	0	0	0	0	0	0	0	
3:30 PM	1	2	0	0	3	0	0	0	0	0	0	0	0	0	0	0	0	
3:45 PM	2	1	0	0	3	0	0	0	0	0	0	0	0	0	0	0	0	
4:00 PM	1	5	0	0	6	0	0	0	0	0	0	0	0	0	0	0	0	
4:15 PM	2	6	0	0	8	0	0	0	0	0	0	0	0	0	0	0	0	
4:30 PM	1	2	0	5	8	0	0	0	0	0	0	0	0	0	0	0	0	
4:45 PM	0	3	0	0	3	0	0	0	0	0	0	0	0	0	0	0	0	
5:00 PM	0	2	0	1	3	0	0	0	0	0	0	0	0	0	0	0	0	
5:15 PM	0	0	0	0	0	0	0	0	0	0	0	0	0	0	0	0	0	
5:30 PM	0	0	0	0	0	0	0	0	0	0	0	0	0	0	0	0	0	
5:45 PM	0	0	0	0	0	0	0	0	0	0	0	0	0	0	0	0	0	
Count Total	20	33	0	10	63	0	0	0	0	0	0	0	0	0	0	0	0	
Peak Hr	8	10	0	2	20	0	0	0	0	0	0	0	0	0	0	0	0	

Sanitarium Rd Deer Park Rd



Date: 01-23-2021
 Count Period: 12:00 PM to 6:00 PM
 Peak Hour: 12:45 PM to 1:45 PM

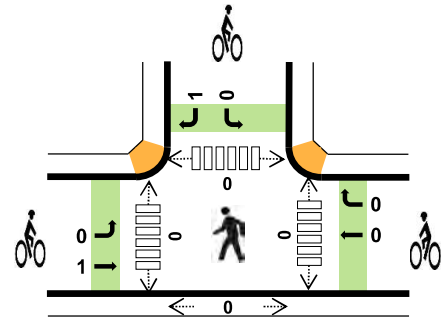
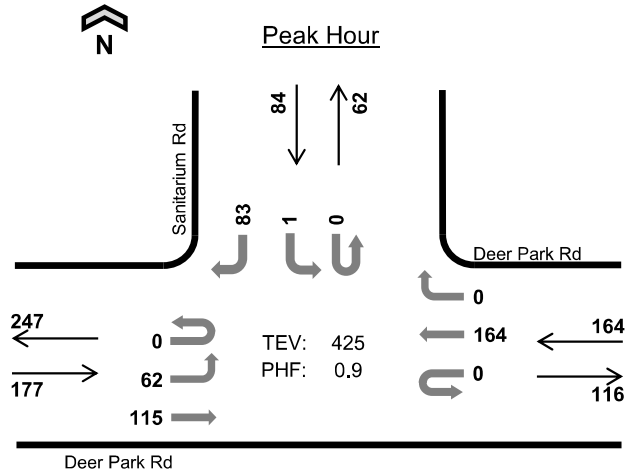

	HV %:	PHF
EB	1.1%	0.96
WB	1.2%	0.80
NB	-	-
SB	1.2%	0.88
TOTAL	1.2%	0.90

Six-Hour Count Summaries

Interval Start	Deer Park Rd Eastbound				Deer Park Rd Westbound				n/a Northbound				Sanitarium Rd Southbound				15-min Total	Rolling One Hour
	UT	LT	TH	RT	UT	LT	TH	RT	UT	LT	TH	RT	UT	LT	TH	RT		
12:45 PM	0	16	27	0	0	0	51	0	0	0	0	0	0	0	0	24	118	0
1:00 PM	0	16	30	0	0	0	28	0	0	0	0	0	0	0	0	20	94	0
1:15 PM	0	13	32	0	0	0	45	0	0	0	0	0	0	0	0	23	113	0
1:30 PM	0	17	26	0	0	0	40	0	0	0	0	0	0	1	0	16	100	425
Peak Hour	All	0	62	115	0	0	164	0	0	0	0	0	0	1	0	83	425	0
	HV	0	0	2	0	0	2	0	0	0	0	0	0	0	0	1	5	0
	HV%	-	0%	2%	-	-	-	1%	-	-	-	-	-	0%	-	1%	1%	0

Note: For all three-hour count summary, see next page.

Interval Start	Heavy Vehicle Totals					Bicycles					Pedestrians (Crossing Leg)				
	EB	WB	NB	SB	Total	EB	WB	NB	SB	Total	East	West	North	South	Total
12:45 PM	0	1	0	1	2	1	0	0	1	2	0	0	0	0	0
1:00 PM	1	1	0	0	2	0	0	0	0	0	0	0	0	0	0
1:15 PM	0	0	0	0	0	0	0	0	0	0	0	0	0	0	0
1:30 PM	1	0	0	0	1	0	0	0	0	0	0	0	0	0	0
Peak Hour	2	2	0	1	5	1	0	0	1	2	0	0	0	0	0

Six-Hour Count Summaries																		
Interval Start	Deer Park Rd				Deer Park Rd				n/a				Sanitarium Rd				15-min Total	Rolling One Hour
	Eastbound				Westbound				Northbound				Southbound					
	UT	LT	TH	RT	UT	LT	TH	RT	UT	LT	TH	RT	UT	LT	TH	RT		
12:00 PM	0	15	29	0	0	0	36	0	0	0	0	0	0	0	0	28	92	0
12:15 PM	0	17	25	0	0	0	27	0	0	0	0	0	0	0	0	28	97	0
12:30 PM	0	12	15	0	0	0	37	0	0	0	0	0	0	0	0	34	98	0
12:45 PM	0	16	27	0	0	0	51	0	0	0	0	0	0	0	24	118	405	
1:00 PM	0	16	30	0	0	0	28	0	0	0	0	0	0	0	20	94	407	0
1:15 PM	0	13	32	0	0	0	45	0	0	0	0	0	0	0	23	113	423	0
1:30 PM	0	17	26	0	0	0	40	0	0	0	0	0	0	1	16	100	425	0
1:45 PM	0	23	24	0	0	0	40	0	0	0	0	0	0	1	19	107	414	0
2:00 PM	0	21	35	0	0	0	23	0	0	0	0	0	0	0	12	91	411	0
2:15 PM	0	21	22	0	0	0	44	0	0	0	0	0	0	0	17	104	402	0
2:30 PM	0	12	26	0	0	0	37	0	0	0	0	0	0	0	22	97	399	0
2:45 PM	0	16	22	0	0	0	24	2	0	0	0	0	0	0	19	83	375	0
3:00 PM	0	16	25	0	0	0	28	0	0	0	0	0	0	0	31	100	384	0
3:15 PM	0	11	23	0	0	0	21	0	0	0	0	0	0	0	15	70	350	0
3:30 PM	0	11	27	0	0	0	35	0	0	0	0	0	0	0	14	87	340	0
3:45 PM	0	11	30	0	0	0	35	0	0	0	0	0	0	0	13	89	346	0
4:00 PM	0	18	33	0	0	0	34	0	0	0	0	0	0	1	14	100	346	0
4:15 PM	0	9	29	0	0	0	30	0	0	0	0	0	0	0	8	76	352	0
4:30 PM	0	13	26	0	0	0	23	0	0	0	0	0	0	0	10	72	337	0
4:45 PM	0	21	20	0	0	0	43	1	0	0	0	0	0	0	15	100	348	0
5:00 PM	0	16	19	0	0	0	29	0	0	0	0	0	0	0	20	84	332	0
5:15 PM	0	11	31	0	0	0	26	0	0	0	0	0	0	0	17	85	341	0
5:30 PM	0	14	24	0	0	0	22	0	0	0	0	0	0	0	7	67	336	0
5:45 PM	0	15	27	0	0	0	20	0	0	0	0	0	0	0	18	80	316	0
Count Total	0	365	627	0	0	0	778	3	0	0	0	0	0	3	428	2,204	0	0
Peak Hour	All	0	62	115	0	0	0	164	0	0	0	0	0	1	83	425	0	0
	HV	0	0	2	0	0	0	2	0	0	0	0	0	0	1	5	0	0
	HV%	-	0%	2%	-	-	-	1%	-	-	-	-	-	0%	-	1%	1%	0
Note: Six-hour count summary volumes include heavy vehicles but exclude bicycles in overall count.																		
Interval Start	Heavy Vehicle Totals					Bicycles					Pedestrians (Crossing Leg)							
	EB	WB	NB	SB	Total	EB	WB	NB	SB	Total	East	West	North	South	Total			
12:00 PM	1	1	0	0	2	0	1	0	0	1	0	0	0	0	0			
12:15 PM	2	3	0	1	6	0	0	0	0	0	0	0	0	0	0			
12:30 PM	0	0	0	0	0	0	2	0	0	2	0	0	0	0	0			
12:45 PM	0	1	0	1	2	1	0	0	1	2	0	0	0	0	0			
1:00 PM	1	1	0	0	2	0	0	0	0	0	0	0	0	0	0			
1:15 PM	0	0	0	0	0	0	0	0	0	0	0	0	0	0	0			
1:30 PM	1	0	0	0	1	0	0	0	0	0	0	0	0	0	0			
1:45 PM	1	2	0	0	3	0	2	0	2	4	0	0	0	0	0			
2:00 PM	0	0	0	0	0	1	0	0	0	1	0	0	0	0	0			
2:15 PM	0	3	0	0	3	0	0	0	0	0	0	0	0	0	0			
2:30 PM	0	1	0	0	1	0	0	0	1	1	0	0	0	0	0			
2:45 PM	0	0	0	0	0	2	0	0	0	2	0	0	0	0	0			
3:00 PM	1	0	0	0	1	0	0	0	0	0	0	0	0	0	0			
3:15 PM	1	0	0	0	1	0	1	0	0	1	0	0	0	0	0			
3:30 PM	0	0	0	0	0	0	0	0	0	0	0	0	0	0	0			
3:45 PM	0	1	0	0	1	1	0	0	0	1	0	0	0	0	0			
4:00 PM	0	1	0	0	1	0	0	0	0	0	0	0	0	0	0			
4:15 PM	0	2	0	0	2	0	0	0	0	0	0	0	0	0	0			
4:30 PM	0	0	0	0	0	0	0	0	1	1	0	0	0	0	0			
4:45 PM	0	0	0	0	0	0	1	0	0	1	0	0	0	0	0			
5:00 PM	0	1	0	0	1	0	0	0	0	0	0	0	0	0	0			
5:15 PM	0	0	0	0	0	0	2	0	0	2	0	0	0	0	0			
5:30 PM	0	0	0	0	0	0	0	0	0	0	0	0	0	0	0			
5:45 PM	0	0	0	0	0	0	0	0	0	0	0	0	0	0	0			
Count Total	8	17	0	2	27	5	9	0	5	19	0	0	0	0	0			
Peak Hr	2	2	0	1	5	1	0	0	1	2	0	0	0	0	0			

Sanitarium Rd Crystal Springs Rd



Date: 02-05-2021
 Count Period: 2:00 PM to 6:00 PM
 Peak Hour: 3:00 PM to 4:00 PM

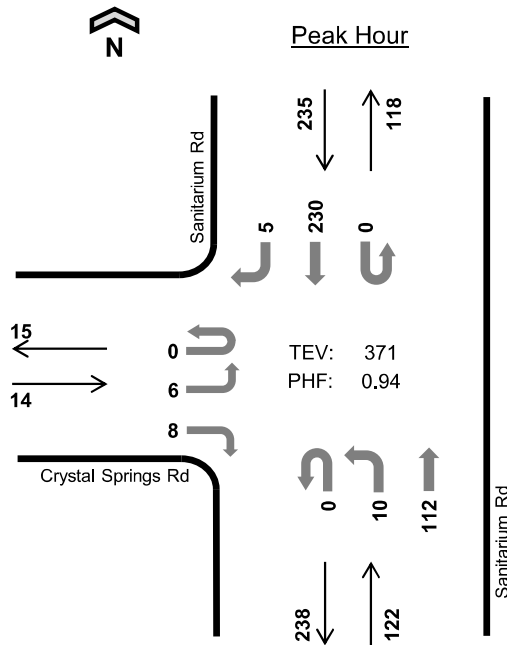

Peak Hour

TEV: 371
 PHF: 0.94

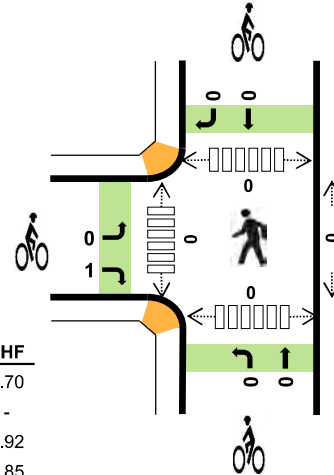

	HV %:	PHF
EB	0.0%	0.70
WB	-	-
NB	0.8%	0.92
SB	2.1%	0.85
TOTAL	1.6%	0.94

Four-Hour Count Summaries

Interval Start	Crystal Springs Rd				n/a				Sanitarium Rd				Sanitarium Rd				15-min Total	Rolling One Hour	
	Eastbound				Westbound				Northbound				Southbound						
	UT	LT	TH	RT	UT	LT	TH	RT	UT	LT	TH	RT	UT	LT	TH	RT			
3:00 PM	0	2	0	3	0	0	0	0	0	1	30	0	0	0	61	1	98	0	
3:15 PM	0	2	0	1	0	0	0	0	0	2	28	0	0	0	57	1	91	0	
3:30 PM	0	0	0	2	0	0	0	0	0	2	26	0	0	0	69	0	99	0	
3:45 PM	0	2	0	2	0	0	0	0	0	5	28	0	0	0	43	3	83	371	
Peak Hour	All	0	6	0	8	0	0	0	0	0	10	112	0	0	0	230	5	371	0
	HV	0	0	0	0	0	0	0	0	0	1	0	0	0	4	1	6	0	
	HV%	-	0%	-	0%	-	-	-	-	-	0%	1%	-	-	2%	20%	2%	0	

Note: For all three-hour count summary, see next page.

Interval Start	Heavy Vehicle Totals					Bicycles					Pedestrians (Crossing Leg)				
	EB	WB	NB	SB	Total	EB	WB	NB	SB	Total	East	West	North	South	Total
3:00 PM	0	0	0	1	1	0	0	0	0	0	0	0	0	0	0
3:15 PM	0	0	0	1	1	0	0	0	0	0	0	0	0	0	0
3:30 PM	0	0	0	0	0	1	0	0	0	1	0	0	0	0	0
3:45 PM	0	0	1	3	4	0	0	0	0	0	0	0	0	0	0
Peak Hour	0	0	1	5	6	1	0	0	0	1	0	0	0	0	0

Four-Hour Count Summaries																			
Interval Start	Crystal Springs Rd				n/a				Sanitarium Rd				Sanitarium Rd				15-min Total	Rolling One Hour	
	Eastbound				Westbound				Northbound				Southbound						
	UT	LT	TH	RT	UT	LT	TH	RT	UT	LT	TH	RT	UT	LT	TH	RT			
2:00 PM	0	1	0	0	0	0	0	0	0	2	26	0	0	0	42	0	71	0	
2:15 PM	0	3	0	1	0	0	0	0	0	4	35	0	0	0	48	1	92	0	
2:30 PM	0	1	0	2	0	0	0	0	0	3	40	0	0	0	58	0	104	0	
2:45 PM	0	1	0	2	0	0	0	0	0	2	36	0	0	0	32	1	74	341	
3:00 PM	0	2	0	3	0	0	0	0	0	1	30	0	0	0	61	1	98	368	
3:15 PM	0	2	0	1	0	0	0	0	0	2	28	0	0	0	57	1	91	367	
3:30 PM	0	0	0	2	0	0	0	0	0	2	26	0	0	0	69	0	99	362	
3:45 PM	0	2	0	2	0	0	0	0	0	5	28	0	0	0	43	3	83	371	
4:00 PM	0	2	0	2	0	0	0	0	0	1	28	0	0	0	45	0	78	351	
4:15 PM	0	2	0	4	0	0	0	0	0	4	30	0	0	0	50	1	91	351	
4:30 PM	0	1	0	1	0	0	0	0	0	3	34	0	0	0	43	0	82	334	
4:45 PM	0	1	0	2	0	0	0	0	0	1	32	0	0	0	31	2	69	320	
5:00 PM	0	2	0	4	0	0	0	0	0	1	34	0	0	0	44	0	85	327	
5:15 PM	0	1	0	0	0	0	0	0	0	2	38	0	0	0	33	0	74	310	
5:30 PM	0	1	0	1	0	0	0	0	0	1	36	0	0	0	33	0	72	300	
5:45 PM	0	0	0	1	0	0	0	0	0	1	24	0	0	0	32	1	59	290	
Count Total	0	22	0	28	0	0	0	0	0	35	505	0	0	0	721	11	1,322	0	
Peak Hour	All	0	6	0	8	0	0	0	0	0	10	112	0	0	0	230	5	371	0
	HV	0	0	0	0	0	0	0	0	0	0	1	0	0	0	4	1	6	0
	HV%	-	0%	-	0%	-	-	-	-	-	0%	1%	-	-	-	2%	20%	2%	0
Note: Four-hour count summary volumes include heavy vehicles but exclude bicycles in overall count.																			
Interval Start	Heavy Vehicle Totals					Bicycles					Pedestrians (Crossing Leg)								
	EB	WB	NB	SB	Total	EB	WB	NB	SB	Total	East	West	North	South	Total				
2:00 PM	0	0	2	4	6	2	0	0	0	2	0	0	0	0	0				
2:15 PM	0	0	0	2	2	0	0	0	0	0	0	0	0	0	0				
2:30 PM	0	0	2	3	5	0	0	0	0	0	0	0	0	0	0				
2:45 PM	0	0	1	2	3	0	0	0	0	0	0	0	0	0	0				
3:00 PM	0	0	0	1	1	0	0	0	0	0	0	0	0	0	0				
3:15 PM	0	0	0	1	1	0	0	0	0	0	0	0	0	0	0				
3:30 PM	0	0	0	0	0	1	0	0	0	1	0	0	0	0	0				
3:45 PM	0	0	1	3	4	0	0	0	0	0	0	0	0	0	0				
4:00 PM	0	0	0	1	1	0	0	0	0	0	0	0	0	0	0				
4:15 PM	0	0	0	1	1	0	0	0	0	0	0	0	0	0	0				
4:30 PM	0	0	1	2	3	0	0	0	0	0	0	0	0	0	0				
4:45 PM	0	0	0	2	2	0	0	0	0	0	0	0	0	0	0				
5:00 PM	0	0	0	1	1	0	0	0	0	0	0	0	0	0	0				
5:15 PM	0	0	0	0	0	0	0	0	0	0	0	0	0	0	0				
5:30 PM	0	0	0	0	0	0	0	0	0	0	0	0	0	0	0				
5:45 PM	0	0	0	1	1	0	0	0	0	0	0	0	0	0	0				
Count Total	0	0	7	24	31	3	0	0	0	3	0	0	0	0	0				
Peak Hr	0	0	1	5	6	1	0	0	0	1	0	0	0	0	0				

Sanitarium Rd Crystal Springs Rd



Date: 02-06-2021
 Count Period: 12:00 PM to 6:00 PM
 Peak Hour: 1:45 PM to 2:45 PM

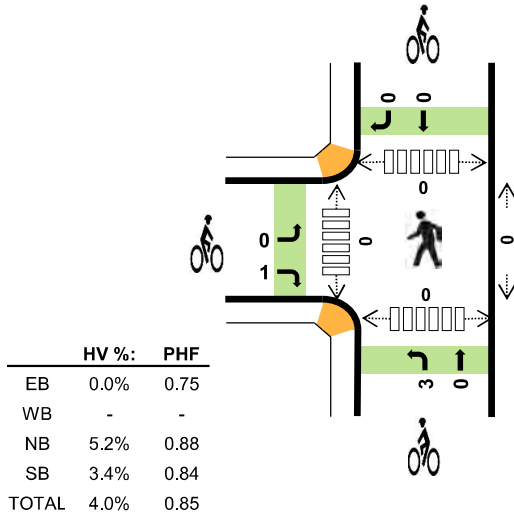
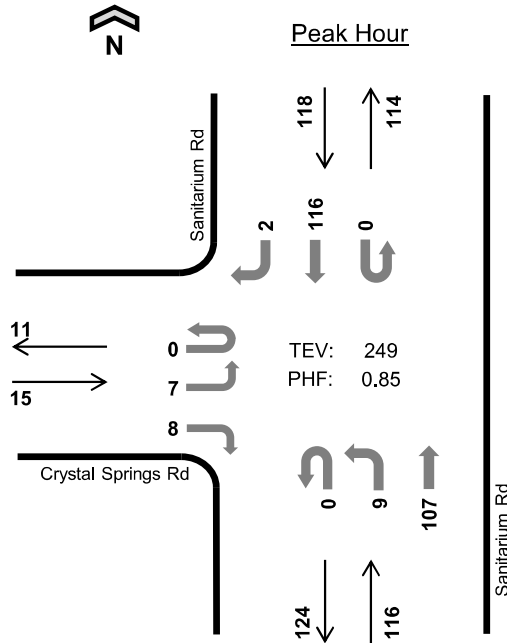

Six-Hour Count Summaries

Interval Start	Crystal Springs Rd				n/a				Sanitarium Rd				Sanitarium Rd				15-min Total	Rolling One Hour	
	Eastbound				Westbound				Northbound				Southbound						
	UT	LT	TH	RT	UT	LT	TH	RT	UT	LT	TH	RT	UT	LT	TH	RT			
1:45 PM	0	1	0	4	0	0	0	0	0	3	30	0	0	0	35	0	73	0	
2:00 PM	0	2	0	0	0	0	0	0	0	3	25	0	0	0	33	2	65	0	
2:15 PM	0	2	0	2	0	0	0	0	0	1	24	0	0	0	24	0	53	0	
2:30 PM	0	2	0	2	0	0	0	0	0	2	28	0	0	0	24	0	58	249	
Peak Hour	All	0	7	0	8	0	0	0	0	0	9	107	0	0	0	116	2	249	0
	HV	0	0	0	0	0	0	0	0	0	6	0	0	0	4	0	10	0	
	HV%	-	0%	-	0%	-	-	-	-	-	0%	6%	-	-	3%	0%	4%	0	

Note: For all three-hour count summary, see next page.

Interval Start	Heavy Vehicle Totals					Bicycles					Pedestrians (Crossing Leg)				
	EB	WB	NB	SB	Total	EB	WB	NB	SB	Total	East	West	North	South	Total
1:45 PM	0	0	3	2	5	1	0	0	0	1	0	0	0	0	0
2:00 PM	0	0	2	1	3	0	0	1	0	1	0	0	0	0	0
2:15 PM	0	0	1	1	2	0	0	0	0	0	0	0	0	0	0
2:30 PM	0	0	0	0	0	0	0	2	0	2	0	0	0	0	0
Peak Hour	0	0	6	4	10	1	0	3	0	4	0	0	0	0	0

Six-Hour Count Summaries																			
Interval Start	Crystal Springs Rd				n/a				Sanitarium Rd				Sanitarium Rd				15-min Total	Rolling One Hour	
	Eastbound				Westbound				Northbound				Southbound						
	UT	LT	TH	RT	UT	LT	TH	RT	UT	LT	TH	RT	UT	LT	TH	RT			
12:00 PM	0	0	0	0	0	0	0	0	0	6	21	0	0	0	23	1	51	0	
12:15 PM	0	1	0	1	0	0	0	0	0	1	22	0	0	0	23	0	48	0	
12:30 PM	0	0	0	4	0	0	0	0	0	2	30	0	0	0	17	0	53	0	
12:45 PM	0	0	0	2	0	0	0	0	0	1	21	0	0	0	32	1	57	209	
1:00 PM	0	1	0	1	0	0	0	0	0	0	30	0	0	0	30	3	65	223	
1:15 PM	0	0	0	2	0	0	0	0	0	5	29	0	0	0	17	1	54	229	
1:30 PM	0	2	0	2	0	0	0	0	0	0	21	0	0	0	24	0	49	225	
1:45 PM	0	1	0	4	0	0	0	0	0	3	30	0	0	0	35	0	73	241	
2:00 PM	0	2	0	0	0	0	0	0	0	3	25	0	0	0	33	2	65	241	
2:15 PM	0	2	0	2	0	0	0	0	0	1	24	0	0	0	24	0	53	240	
2:30 PM	0	2	0	2	0	0	0	0	0	2	28	0	0	0	24	0	58	249	
2:45 PM	0	2	0	1	0	0	0	0	0	2	25	0	0	0	28	0	58	234	
3:00 PM	0	2	0	0	0	0	0	0	0	0	20	0	0	0	43	0	65	234	
3:15 PM	0	1	0	2	0	0	0	0	0	2	18	0	0	0	22	0	45	226	
3:30 PM	0	0	0	0	0	0	0	0	0	0	15	0	0	0	28	0	43	211	
3:45 PM	0	0	0	2	0	0	0	0	0	1	21	0	0	0	25	1	50	203	
4:00 PM	0	0	0	6	0	0	0	0	0	1	25	0	0	0	20	0	52	190	
4:15 PM	0	0	0	2	0	0	0	0	0	2	17	0	0	0	21	1	43	188	
4:30 PM	0	0	0	2	0	0	0	0	0	2	18	0	0	0	18	2	42	187	
4:45 PM	0	1	0	1	0	0	0	0	0	0	18	0	0	0	15	3	38	175	
5:00 PM	0	2	0	1	0	0	0	0	0	1	24	0	0	0	17	0	45	168	
5:15 PM	0	1	0	3	0	0	0	0	0	2	14	0	0	0	17	0	37	162	
5:30 PM	0	1	0	1	0	0	0	0	0	3	28	0	0	0	20	0	53	173	
5:45 PM	0	0	0	1	0	0	0	0	0	1	13	0	0	0	18	1	34	169	
Count Total	0	21	0	42	0	0	0	0	0	41	537	0	0	0	574	16	1,231	0	
Peak Hour	All	0	7	0	8	0	0	0	0	0	9	107	0	0	0	116	2	249	0
	HV	0	0	0	0	0	0	0	0	0	0	6	0	0	0	4	0	10	0
	HV%	-	0%	-	0%	-	-	-	-	-	0%	6%	-	-	-	3%	0%	4%	0
Note: Six-hour count summary volumes include heavy vehicles but exclude bicycles in overall count.																			
Interval Start	Heavy Vehicle Totals					Bicycles					Pedestrians (Crossing Leg)								
	EB	WB	NB	SB	Total	EB	WB	NB	SB	Total	East	West	North	South	Total				
12:00 PM	0	0	0	0	0	0	0	0	0	0	0	1	0	0	0	1			
12:15 PM	0	0	2	0	2	1	0	1	0	2	0	0	0	0	0				
12:30 PM	0	0	1	0	1	0	0	1	0	1	0	0	0	0	0				
12:45 PM	0	0	0	0	0	0	0	0	0	0	0	0	0	0	0				
1:00 PM	0	0	0	3	3	0	0	0	0	0	0	0	0	0	0				
1:15 PM	0	0	0	0	0	0	0	2	4	6	1	0	0	0	1				
1:30 PM	0	0	1	1	2	1	0	2	1	4	0	1	0	0	1				
1:45 PM	0	0	3	2	5	1	0	0	0	1	0	0	0	0					
2:00 PM	0	0	2	1	3	0	0	1	0	1	0	0	0	0	0				
2:15 PM	0	0	1	1	2	0	0	0	0	0	0	0	0	0	0				
2:30 PM	0	0	0	0	0	0	0	2	0	2	0	0	0	0	0				
2:45 PM	0	0	0	1	1	1	0	0	0	1	0	0	0	0	0				
3:00 PM	0	0	1	1	2	0	0	0	0	0	0	0	0	0	0				
3:15 PM	0	0	0	2	2	0	0	1	0	1	0	0	0	0	0				
3:30 PM	0	0	0	1	1	1	0	0	0	1	0	2	0	0	2				
3:45 PM	0	0	0	0	0	1	0	0	0	1	0	0	0	0	0				
4:00 PM	0	0	1	2	3	0	0	0	0	0	0	0	0	0	0				
4:15 PM	0	0	0	1	1	0	0	0	0	0	0	0	0	0	0				
4:30 PM	0	0	0	1	1	0	0	0	0	0	0	0	0	0	0				
4:45 PM	0	0	0	0	0	0	0	0	0	0	0	0	0	0	0				
5:00 PM	0	0	0	0	0	0	0	0	0	0	0	0	0	0	0				
5:15 PM	0	0	0	0	0	0	0	0	0	0	0	0	0	0	0				
5:30 PM	0	0	0	0	0	0	0	0	0	0	0	0	0	0	0				
5:45 PM	0	0	0	0	0	0	0	0	0	0	0	0	0	0	0				
Count Total	0	0	12	17	29	6	0	10	5	21	1	4	0	0	5				
Peak Hr	0	0	6	4	10	1	0	3	0	4	0	0	0	0	0				

Sanitarium Rd Deer Park Rd



Date: 02-05-2021
 Count Period: 2:00 PM to 6:00 PM
 Peak Hour: 3:30 PM to 4:30 PM

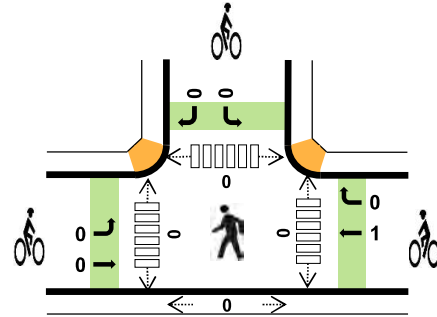
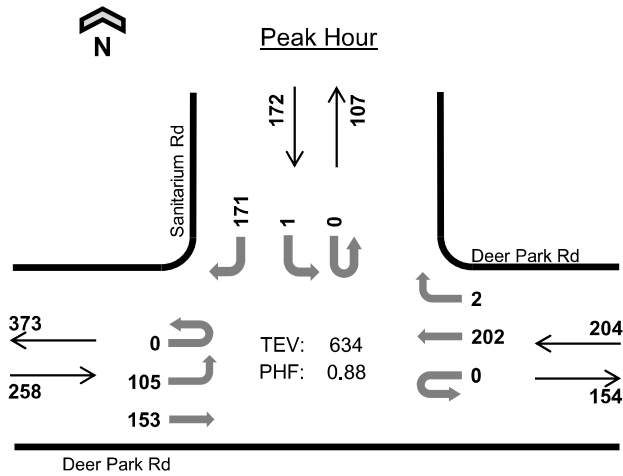

	HV %:	PHF
EB	2.3%	0.90
WB	6.4%	0.85
NB	-	-
SB	4.1%	0.77
TOTAL	4.1%	0.88

Four-Hour Count Summaries

Interval Start	Deer Park Rd Eastbound				Deer Park Rd Westbound				n/a Northbound				Sanitarium Rd Southbound				15-min Total	Rolling One Hour
	UT	LT	TH	RT	UT	LT	TH	RT	UT	LT	TH	RT	UT	LT	TH	RT		
3:30 PM	0	23	41	0	0	0	60	0	0	0	0	0	0	0	0	56	180	0
3:45 PM	0	28	44	0	0	0	47	1	0	0	0	0	0	0	0	41	161	0
4:00 PM	0	22	33	0	0	0	37	0	0	0	0	0	0	1	0	30	123	0
4:15 PM	0	32	35	0	0	0	58	1	0	0	0	0	0	0	0	44	170	634
Peak Hour	All	0	105	153	0	0	202	2	0	0	0	0	0	1	0	171	634	0
	HV	0	2	4	0	0	12	1	0	0	0	0	0	1	0	6	26	0
	HV%	-	2%	3%	-	-	6%	50%	-	-	-	-	-	100%	-	4%	4%	0

Note: For all three-hour count summary, see next page.

Interval Start	Heavy Vehicle Totals					Bicycles					Pedestrians (Crossing Leg)				
	EB	WB	NB	SB	Total	EB	WB	NB	SB	Total	East	West	North	South	Total
3:30 PM	1	2	0	1	4	0	1	0	0	1	0	0	0	0	0
3:45 PM	2	3	0	3	8	0	0	0	0	0	0	0	0	0	0
4:00 PM	0	2	0	1	3	0	0	0	0	0	0	0	0	0	0
4:15 PM	3	6	0	2	11	0	0	0	0	0	0	0	0	0	0
Peak Hour	6	13	0	7	26	0	1	0	0	1	0	0	0	0	0

Four-Hour Count Summaries																			
Interval Start	Deer Park Rd				Deer Park Rd				n/a				Sanitarium Rd				15-min Total	Rolling One Hour	
	Eastbound				Westbound				Northbound				Southbound						
	UT	LT	TH	RT	UT	LT	TH	RT	UT	LT	TH	RT	UT	LT	TH	RT			
2:00 PM	0	24	32	0	0	0	30	1	0	0	0	0	0	0	0	35	122	0	
2:15 PM	0	36	22	0	0	0	43	2	0	0	0	0	0	1	0	34	138	0	
2:30 PM	0	27	36	0	0	0	36	4	0	0	0	0	0	2	0	47	152	0	
2:45 PM	0	29	21	0	0	0	38	1	0	0	0	0	0	1	0	31	121	533	
3:00 PM	0	26	32	0	0	0	35	0	0	0	0	0	0	0	0	56	149	560	
3:15 PM	0	26	28	0	0	0	37	1	0	0	0	0	0	0	0	45	137	559	
3:30 PM	0	23	41	0	0	0	60	0	0	0	0	0	0	0	56	180	587		
3:45 PM	0	28	44	0	0	0	47	1	0	0	0	0	0	0	41	161	627		
4:00 PM	0	22	33	0	0	0	37	0	0	0	0	0	0	1	0	30	123	601	
4:15 PM	0	32	35	0	0	0	58	1	0	0	0	0	0	0	0	44	170	634	
4:30 PM	0	29	50	0	0	0	36	1	0	0	0	0	0	0	0	32	148	602	
4:45 PM	0	26	30	0	0	0	29	0	0	0	0	0	0	1	0	29	115	556	
5:00 PM	0	31	49	0	0	0	37	0	0	0	0	0	0	0	0	40	157	590	
5:15 PM	0	35	53	0	0	0	21	0	0	0	0	0	0	0	0	30	139	559	
5:30 PM	0	29	50	0	0	0	17	0	0	0	0	0	0	0	0	29	125	536	
5:45 PM	0	21	38	0	0	0	27	0	0	0	0	0	0	0	0	19	105	526	
Count Total	0	444	594	0	0	0	588	12	0	0	0	0	0	6	0	598	2,242	0	
Peak Hour	All	0	105	153	0	0	0	202	2	0	0	0	0	0	1	0	171	634	0
	HV	0	2	4	0	0	0	12	1	0	0	0	0	0	1	0	6	26	0
	HV%	-	2%	3%	-	-	-	6%	50%	-	-	-	-	-	100%	-	4%	4%	0
<i>Note: Four-hour count summary volumes include heavy vehicles but exclude bicycles in overall count.</i>																			
Interval Start	Heavy Vehicle Totals					Bicycles					Pedestrians (Crossing Leg)								
	EB	WB	NB	SB	Total	EB	WB	NB	SB	Total	East	West	North	South	Total				
2:00 PM	5	1	0	3	9	0	0	0	0	0	0	0	0	0	0	0	0	0	
2:15 PM	4	3	0	2	9	0	0	0	0	0	0	0	0	0	0	0	0	0	
2:30 PM	1	1	0	1	3	0	0	0	0	0	0	0	0	0	0	0	0	0	
2:45 PM	0	3	0	4	7	0	0	0	0	0	0	0	0	0	0	0	0	0	
3:00 PM	1	1	0	0	2	0	0	0	0	0	0	0	0	0	0	0	0	0	
3:15 PM	0	3	0	0	3	0	0	0	0	0	0	0	0	0	0	0	0	0	
3:30 PM	1	2	0	1	4	0	1	0	0	1	0	0	0	0	0	0	0	0	
3:45 PM	2	3	0	3	8	0	0	0	0	0	0	0	0	0	0	0	0	0	
4:00 PM	0	2	0	1	3	0	0	0	0	0	0	0	0	0	0	0	0	0	
4:15 PM	3	6	0	2	11	0	0	0	0	0	0	0	0	0	0	0	0	0	
4:30 PM	0	5	0	0	5	0	0	0	0	0	0	0	0	0	0	0	0	0	
4:45 PM	0	3	0	3	6	0	0	0	0	0	0	0	0	0	0	0	0	0	
5:00 PM	0	0	0	0	0	0	0	0	0	0	0	0	0	0	0	0	0	0	
5:15 PM	0	0	0	0	0	0	0	0	0	0	0	0	0	0	0	0	0	0	
5:30 PM	0	1	0	0	1	0	0	0	0	0	0	0	0	0	0	0	0	0	
5:45 PM	0	0	0	0	0	0	0	0	0	0	0	0	0	0	0	0	0	0	
Count Total	17	34	0	20	71	0	1	0	0	1	0	0	0	0	0	0	0	0	
Peak Hr	6	13	0	7	26	0	1	0	0	1	0	0	0	0	0	0	0	0	

Sanitarium Rd Deer Park Rd



Date: 02-06-2021
 Count Period: 12:00 PM to 6:00 PM
 Peak Hour: 1:30 PM to 2:30 PM

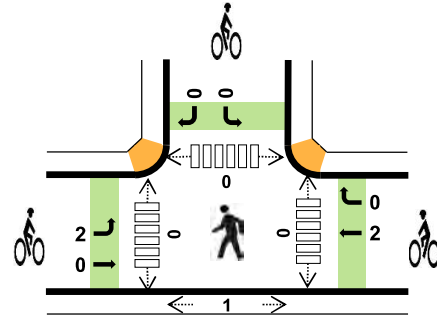
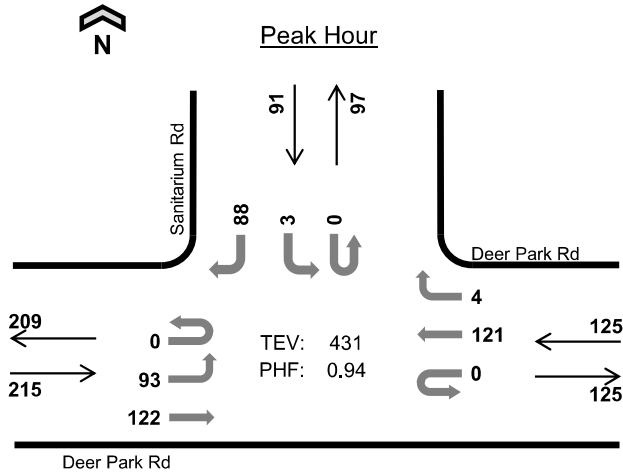

	HV %:	PHF
EB	2.3%	0.88
WB	7.2%	0.76
NB	-	-
SB	1.1%	0.84
TOTAL	3.5%	0.94

Six-Hour Count Summaries

Interval Start	Deer Park Rd				Deer Park Rd				n/a				Sanitarium Rd				15-min Total	Rolling One Hour	
	Eastbound				Westbound				Northbound				Southbound						
	UT	LT	TH	RT	UT	LT	TH	RT	UT	LT	TH	RT	UT	LT	TH	RT			
1:30 PM	0	21	34	0	0	0	39	2	0	0	0	0	0	2	0	15	113	0	
1:45 PM	0	26	27	0	0	0	34	1	0	0	0	0	0	0	0	23	111	0	
2:00 PM	0	24	37	0	0	0	26	1	0	0	0	0	0	1	0	26	115	0	
2:15 PM	0	22	24	0	0	0	22	0	0	0	0	0	0	0	0	24	92	431	
Peak Hour	All	0	93	122	0	0	0	121	4	0	0	0	0	0	3	0	88	431	0
	HV	0	1	4	0	0	0	8	1	0	0	0	0	0	1	0	0	15	0
	HV%	-	1%	3%	-	-	-	7%	25%	-	-	-	-	-	33%	-	0%	3%	0

Note: For all three-hour count summary, see next page.

Interval Start	Heavy Vehicle Totals					Bicycles					Pedestrians (Crossing Leg)				
	EB	WB	NB	SB	Total	EB	WB	NB	SB	Total	East	West	North	South	Total
1:30 PM	1	4	0	0	5	1	0	0	0	1	0	0	0	1	1
1:45 PM	0	3	0	0	3	0	0	0	0	0	0	0	0	0	
2:00 PM	2	1	0	1	4	1	0	0	0	1	0	0	0	0	
2:15 PM	2	1	0	0	3	0	2	0	0	2	0	0	0	0	
Peak Hour	5	9	0	1	15	2	2	0	0	4	0	0	0	1	1

Six-Hour Count Summaries																			
Interval Start	Deer Park Rd				Deer Park Rd				n/a				Sanitarium Rd				15-min Total	Rolling One Hour	
	Eastbound				Westbound				Northbound				Southbound						
	UT	LT	TH	RT	UT	LT	TH	RT	UT	LT	TH	RT	UT	LT	TH	RT			
12:00 PM	0	18	19	0	0	0	23	5	0	0	0	0	0	0	0	21	86	0	
12:15 PM	0	23	17	0	0	0	36	0	0	0	0	0	0	0	0	21	97	0	
12:30 PM	0	22	42	0	0	0	29	1	0	0	0	0	0	0	0	19	113	0	
12:45 PM	1	16	27	0	0	0	27	0	0	0	0	0	0	0	0	27	98	394	
1:00 PM	0	25	29	0	0	0	36	1	0	0	0	0	0	0	0	22	113	421	
1:15 PM	0	30	15	0	0	0	14	0	0	0	0	0	0	1	0	16	76	400	
1:30 PM	0	21	34	0	0	0	39	2	0	0	0	0	0	2	0	15	113	400	
1:45 PM	0	26	27	0	0	0	34	1	0	0	0	0	0	0	0	23	111	413	
2:00 PM	0	24	37	0	0	0	26	1	0	0	0	0	0	1	0	26	115	415	
2:15 PM	0	22	24	0	0	0	22	0	0	0	0	0	0	0	0	24	92	431	
2:30 PM	0	19	18	0	0	0	34	0	0	0	0	0	0	0	0	26	97	415	
2:45 PM	0	20	26	0	0	0	31	1	0	0	0	0	0	0	0	27	105	409	
3:00 PM	0	18	12	0	0	0	33	0	0	0	0	0	0	0	0	36	99	393	
3:15 PM	0	16	23	0	0	0	33	1	0	0	0	0	0	1	0	20	94	395	
3:30 PM	0	15	24	0	0	0	32	0	0	0	0	0	0	1	0	19	91	389	
3:45 PM	0	17	28	0	0	0	37	1	0	0	0	0	0	0	0	24	107	391	
4:00 PM	0	23	20	0	0	0	31	1	0	0	0	0	0	2	0	14	91	383	
4:15 PM	0	18	34	0	0	0	44	0	0	0	0	0	0	0	0	23	119	408	
4:30 PM	0	16	25	0	0	0	18	0	0	0	0	0	0	0	0	20	79	396	
4:45 PM	0	15	26	0	0	0	33	0	0	0	0	0	0	0	0	13	87	376	
5:00 PM	0	20	40	0	1	0	34	0	0	0	0	0	0	0	0	16	111	396	
5:15 PM	0	12	25	0	0	0	21	0	0	0	0	0	0	0	0	14	72	349	
5:30 PM	0	27	24	0	0	0	21	0	0	0	0	0	0	0	0	20	92	362	
5:45 PM	0	11	15	0	0	0	36	0	0	0	0	0	0	0	0	15	77	352	
Count Total	1	474	611	0	1	0	724	15	0	0	0	0	0	8	0	501	2,335	0	
Peak Hour	All	0	93	122	0	0	0	121	4	0	0	0	0	0	3	0	88	431	0
	HV	0	1	4	0	0	0	8	1	0	0	0	0	0	1	0	0	15	0
	HV%	-	1%	3%	-	-	-	7%	25%	-	-	-	-	-	33%	-	0%	3%	0
Note: Six-hour count summary volumes include heavy vehicles but exclude bicycles in overall count.																			
Interval Start	Heavy Vehicle Totals					Bicycles					Pedestrians (Crossing Leg)								
	EB	WB	NB	SB	Total	EB	WB	NB	SB	Total	East	West	North	South	Total				
12:00 PM	2	1	0	0	3	0	0	0	0	0	0	0	0	0	0				
12:15 PM	1	3	0	0	4	0	0	0	1	1	0	0	0	0	0				
12:30 PM	2	1	0	0	3	0	0	0	1	1	0	0	0	0	0				
12:45 PM	1	1	0	0	2	0	6	0	0	6	0	0	0	0	0				
1:00 PM	2	1	0	2	5	0	0	0	0	0	0	0	0	0	0				
1:15 PM	1	2	0	0	3	0	0	0	1	1	0	0	0	1	1				
1:30 PM	1	4	0	0	5	1	0	0	0	1	0	0	0	1	1				
1:45 PM	0	3	0	0	3	0	0	0	0	0	0	0	0	0	0				
2:00 PM	2	1	0	1	4	1	0	0	0	1	0	0	0	0	0				
2:15 PM	2	1	0	0	3	0	2	0	0	2	0	0	0	0	0				
2:30 PM	1	1	0	0	2	2	1	0	0	3	0	1	0	0	1				
2:45 PM	0	1	0	1	2	0	1	0	0	1	0	0	0	0	0				
3:00 PM	1	2	0	0	3	0	0	0	0	0	0	0	0	0	0				
3:15 PM	0	0	0	0	0	1	0	0	0	1	0	0	0	0	0				
3:30 PM	0	0	0	1	1	0	0	0	0	0	0	0	0	0	0				
3:45 PM	0	1	0	0	1	0	0	0	0	0	0	0	0	0	0				
4:00 PM	0	2	0	1	3	0	0	0	0	0	0	0	0	0	0				
4:15 PM	0	3	0	0	3	0	0	0	0	0	0	0	0	0	0				
4:30 PM	0	1	0	2	3	0	2	0	0	2	0	0	0	0	0				
4:45 PM	0	3	0	0	3	0	0	0	0	0	0	0	0	0	0				
5:00 PM	0	0	0	0	0	0	0	0	0	0	0	0	0	0	0				
5:15 PM	0	0	0	0	0	0	0	0	0	0	0	0	0	0	0				
5:30 PM	0	0	0	0	0	0	0	0	0	0	0	0	0	0	0				
5:45 PM	0	0	0	0	0	0	0	0	0	0	0	0	0	0	0				
Count Total	16	32	0	8	56	5	12	0	3	20	0	1	0	2	3				
Peak Hr	5	9	0	1	15	2	2	0	0	4	0	0	0	1	1				

Silverado Trail N Deer Park Rd



Peak Hour

Date: 02-05-2021
Count Period: 2:00 PM to 6:00 PM
Peak Hour: 3:30 PM to 4:30 PM

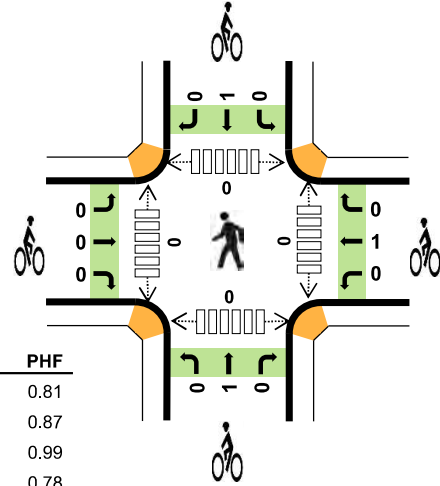
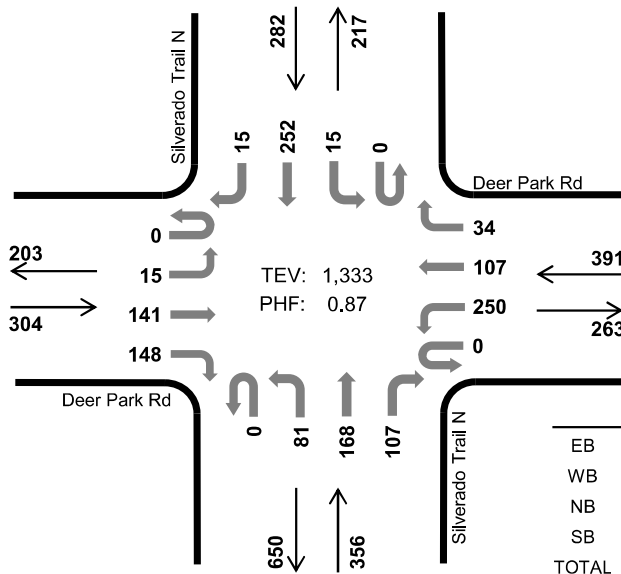

	HV %:	PHF
EB	0.3%	0.81
WB	4.6%	0.87
NB	2.0%	0.99
SB	5.3%	0.78
TOTAL	3.1%	0.87

Four-Hour Count Summaries

Interval Start	Deer Park Rd Eastbound				Deer Park Rd Westbound				Silverado Trail N Northbound				Silverado Trail N Southbound				15-min Total	Rolling One Hour	
	UT	LT	TH	RT	UT	LT	TH	RT	UT	LT	TH	RT	UT	LT	TH	RT			
3:30 PM	0	6	34	54	0	66	32	14	0	28	36	25	0	3	84	3	385	0	
3:45 PM	0	3	39	32	0	76	26	5	0	17	44	29	0	5	50	6	332	0	
4:00 PM	0	4	27	37	0	41	20	8	0	17	46	26	0	2	67	3	298	0	
4:15 PM	0	2	41	25	0	67	29	7	0	19	42	27	0	5	51	3	318	1,333	
Peak Hour	All	0	15	141	148	0	250	107	34	0	81	168	107	0	15	252	15	1,333	0
	HV	0	0	0	1	0	9	1	8	0	3	4	0	0	6	8	1	41	0
	HV%	-	0%	0%	1%	-	4%	1%	24%	-	4%	2%	0%	-	40%	3%	7%	3%	0

Note: For all three-hour count summary, see next page.

Interval Start	Heavy Vehicle Totals					Bicycles					Pedestrians (Crossing Leg)				
	EB	WB	NB	SB	Total	EB	WB	NB	SB	Total	East	West	North	South	Total
3:30 PM	1	3	4	4	12	0	1	0	0	1	0	0	0	0	0
3:45 PM	0	4	2	4	10	0	0	0	1	1	0	0	0	0	0
4:00 PM	0	2	0	2	4	0	0	0	0	0	0	0	0	0	0
4:15 PM	0	9	1	5	15	0	0	1	0	1	0	0	0	0	0
Peak Hour	1	18	7	15	41	0	1	1	1	3	0	0	0	0	0

Four-Hour Count Summaries																			
Interval Start	Deer Park Rd				Deer Park Rd				Silverado Trail N				Silverado Trail N				15-min Total	Rolling One Hour	
	Eastbound				Westbound				Northbound				Southbound						
	UT	LT	TH	RT	UT	LT	TH	RT	UT	LT	TH	RT	UT	LT	TH	RT			
2:00 PM	0	5	33	10	0	33	38	4	0	25	24	18	0	2	33	6	231	0	
2:15 PM	0	1	26	4	0	39	34	8	0	9	29	24	0	7	36	9	226	0	
2:30 PM	0	3	32	17	0	50	24	10	0	21	39	29	0	0	50	6	281	0	
2:45 PM	0	5	32	19	0	42	19	5	0	25	31	21	0	1	46	2	248	986	
3:00 PM	0	10	28	13	0	60	27	9	0	10	29	26	0	2	51	3	268	1,023	
3:15 PM	0	4	34	27	0	43	14	8	0	14	32	19	0	2	58	9	264	1,061	
3:30 PM	0	6	34	54	0	66	32	14	0	28	36	25	0	3	84	3	385	1,165	
3:45 PM	0	3	39	32	0	76	26	5	0	17	44	29	0	5	50	6	332	1,249	
4:00 PM	0	4	27	37	0	41	20	8	0	17	46	26	0	2	67	3	298	1,279	
4:15 PM	0	2	41	25	0	67	29	7	0	19	42	27	0	5	51	3	318	1,333	
4:30 PM	0	2	48	26	0	46	19	5	0	14	38	25	0	2	70	0	295	1,243	
4:45 PM	0	4	33	26	0	28	22	6	0	10	40	21	0	1	32	1	224	1,135	
5:00 PM	0	3	52	12	0	51	28	0	0	23	27	32	0	2	44	3	277	1,114	
5:15 PM	0	0	54	20	0	34	14	1	0	14	36	29	0	5	43	5	255	1,051	
5:30 PM	0	2	43	12	0	28	16	3	0	15	26	26	0	1	39	2	213	969	
5:45 PM	0	3	37	11	0	29	17	1	0	7	21	24	0	1	34	5	190	935	
Count Total	0	57	593	345	0	733	379	94	0	268	540	401	0	41	788	66	4,305	0	
Peak Hour	All	0	15	141	148	0	250	107	34	0	81	168	107	0	15	252	15	1,333	0
	HV	0	0	0	1	0	9	1	8	0	3	4	0	0	6	8	1	41	0
	HV%	-	0%	0%	1%	-	4%	1%	24%	-	4%	2%	0%	-	40%	3%	7%	3%	0
Note: Four-hour count summary volumes include heavy vehicles but exclude bicycles in overall count.																			
Interval Start	Heavy Vehicle Totals					Bicycles					Pedestrians (Crossing Leg)								
	EB	WB	NB	SB	Total	EB	WB	NB	SB	Total	East	West	North	South	Total				
2:00 PM	4	4	2	5	15	0	0	0	3	3	0	0	0	0	0				
2:15 PM	2	5	3	7	17	0	0	0	0	0	0	0	0	0	0				
2:30 PM	0	1	4	4	9	0	0	0	1	1	0	0	0	0	0				
2:45 PM	4	6	2	1	13	0	0	0	0	0	0	0	0	0	0				
3:00 PM	0	1	3	3	7	0	0	0	0	0	0	0	0	0	0				
3:15 PM	2	2	1	4	9	0	0	0	0	0	0	0	0	0	0				
3:30 PM	1	3	4	4	12	0	1	0	0	1	0	0	0	0	0				
3:45 PM	0	4	2	4	10	0	0	0	1	1	0	0	0	0	0				
4:00 PM	0	2	0	2	4	0	0	0	0	0	0	0	0	0	0				
4:15 PM	0	9	1	5	15	0	0	1	0	1	0	0	0	0	0				
4:30 PM	0	6	1	1	8	0	0	0	1	1	0	0	0	0	0				
4:45 PM	0	4	0	2	6	0	0	1	0	1	0	0	0	0	0				
5:00 PM	0	0	0	1	1	0	0	0	0	0	0	0	0	0	0				
5:15 PM	0	0	0	4	4	0	0	0	0	0	0	0	0	0	0				
5:30 PM	0	1	0	2	3	0	0	0	0	0	0	0	0	0	0				
5:45 PM	0	0	0	5	5	0	0	0	0	0	0	0	0	0	0				
Count Total	13	48	23	54	138	0	1	2	6	9	0	0	0	0	0				
Peak Hour	1	18	7	15	41	0	1	1	1	3	0	0	0	0	0				

Silverado Trail N Deer Park Rd



Peak Hour

Date: 02-06-2021
Count Period: 12:00 PM to 6:00 PM
Peak Hour: 2:15 PM to 3:15 PM

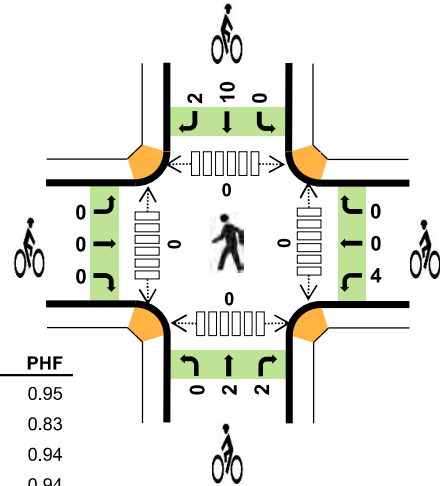
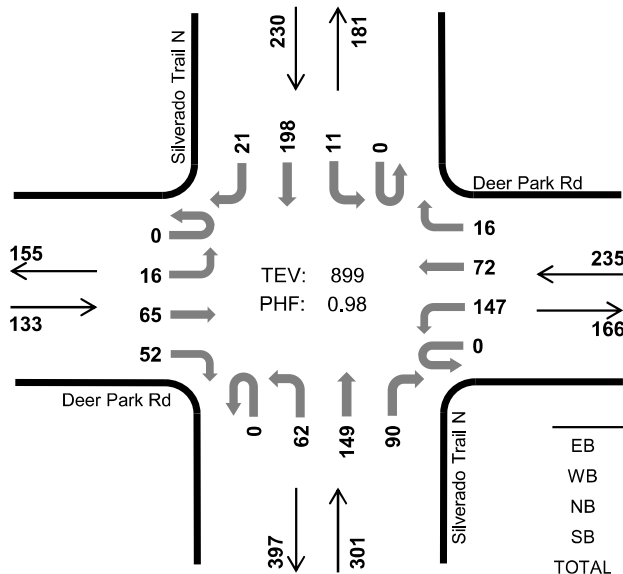

	HV %:	PHF
EB	0.8%	0.95
WB	2.6%	0.83
NB	0.3%	0.94
SB	4.8%	0.94
TOTAL	2.1%	0.98

Six-Hour Count Summaries

Interval Start	Deer Park Rd Eastbound				Deer Park Rd Westbound				Silverado Trail N Northbound				Silverado Trail N Southbound				15-min Total	Rolling One Hour	
	UT	LT	TH	RT	UT	LT	TH	RT	UT	LT	TH	RT	UT	LT	TH	RT			
2:15 PM	0	5	16	14	0	29	14	3	0	16	35	29	0	3	53	5	222	0	
2:30 PM	0	2	14	15	0	42	12	5	0	17	37	22	0	3	47	5	221	0	
2:45 PM	0	5	22	7	0	28	27	4	0	10	42	21	0	3	54	4	227	0	
3:00 PM	0	4	13	16	0	48	19	4	0	19	35	18	0	2	44	7	229	899	
Peak Hour	All	0	16	65	52	0	147	72	16	0	62	149	90	0	11	198	21	899	0
	HV	0	1	0	0	0	0	1	5	0	0	0	1	0	3	6	2	19	0
	HV%	-	6%	0%	0%	-	0%	1%	31%	-	0%	0%	1%	-	27%	3%	10%	2%	0

Note: For all three-hour count summary, see next page.

Interval Start	Heavy Vehicle Totals					Bicycles					Pedestrians (Crossing Leg)				
	EB	WB	NB	SB	Total	EB	WB	NB	SB	Total	East	West	North	South	Total
2:15 PM	0	1	1	3	5	0	2	1	0	3	0	0	0	0	0
2:30 PM	0	1	0	5	6	0	1	2	3	6	0	0	0	0	0
2:45 PM	0	2	0	1	3	0	1	1	2	4	0	0	0	0	0
3:00 PM	1	2	0	2	5	0	0	0	7	7	0	0	0	0	0
Peak Hour	1	6	1	11	19	0	4	4	12	20	0	0	0	0	0

Six-Hour Count Summaries																			
Interval Start	Deer Park Rd				Deer Park Rd				Silverado Trail N				Silverado Trail N				15-min Total	Rolling One Hour	
	Eastbound				Westbound				Northbound				Southbound						
	UT	LT	TH	RT	UT	LT	TH	RT	UT	LT	TH	RT	UT	LT	TH	RT			
12:00 PM	0	7	17	12	0	26	12	3	0	15	53	14	0	6	33	4	202	0	
12:15 PM	0	4	19	24	0	35	26	4	0	16	44	21	0	3	22	2	220	0	
12:30 PM	0	3	28	10	0	29	15	4	0	11	58	32	0	5	40	4	239	0	
12:45 PM	0	2	24	8	0	26	24	6	0	12	44	15	0	2	39	5	207	868	
1:00 PM	0	3	23	6	0	28	23	6	1	14	24	26	0	5	21	4	184	850	
1:15 PM	0	3	28	6	0	14	12	8	0	18	39	17	0	3	35	3	186	816	
1:30 PM	0	8	22	11	0	27	24	2	0	14	39	30	0	2	37	5	221	798	
1:45 PM	0	2	24	14	0	31	21	3	1	14	38	25	0	5	34	3	215	806	
2:00 PM	0	5	31	9	1	24	26	4	0	18	30	27	0	2	44	6	227	849	
2:15 PM	0	5	16	14	0	29	14	3	0	16	35	29	0	3	53	5	222	885	
2:30 PM	0	2	14	15	0	42	12	5	0	17	37	22	0	3	47	5	221	885	
2:45 PM	0	5	22	7	0	28	27	4	0	10	42	21	0	3	54	4	227	897	
3:00 PM	0	4	13	16	0	48	19	4	0	19	35	18	0	2	44	7	229	899	
3:15 PM	0	2	20	12	0	29	19	3	0	15	28	15	0	0	61	7	211	888	
3:30 PM	0	2	20	15	0	36	11	6	0	12	35	17	0	2	54	5	215	882	
3:45 PM	0	4	22	17	0	42	16	5	0	11	21	20	0	1	52	3	214	869	
4:00 PM	0	3	29	18	0	28	13	2	0	8	35	20	0	1	49	3	209	849	
4:15 PM	0	3	22	3	0	46	16	7	0	12	25	23	0	0	40	3	200	838	
4:30 PM	0	4	20	13	0	20	12	3	0	7	30	19	0	4	46	2	180	803	
4:45 PM	1	4	29	13	0	19	24	4	0	7	18	11	0	4	54	6	194	783	
5:00 PM	1	2	35	11	0	34	12	4	0	9	16	18	0	3	45	2	192	766	
5:15 PM	0	4	20	10	0	13	20	2	0	8	29	21	0	0	37	4	168	734	
5:30 PM	0	4	24	8	0	28	12	0	0	9	26	24	0	1	34	2	172	726	
5:45 PM	0	3	11	10	0	26	24	1	0	5	17	13	0	3	23	2	138	670	
Count Total	2	88	533	282	1	708	434	93	2	297	798	498	0	63	998	96	4,893	0	
Peak Hour	All	0	16	65	52	0	147	72	16	0	62	149	90	0	11	198	21	899	0
	HV	0	1	0	0	0	0	1	5	0	0	0	1	0	3	6	2	19	0
	HV%	-	6%	0%	0%	-	0%	1%	31%	-	0%	0%	1%	-	27%	3%	10%	2%	0
Note: Six-hour count summary volumes include heavy vehicles but exclude bicycles in overall count.																			
Interval Start	Heavy Vehicle Totals					Bicycles					Pedestrians (Crossing Leg)								
	EB	WB	NB	SB	Total	EB	WB	NB	SB	Total	East	West	North	South	Total				
12:00 PM	0	1	2	3	6	0	0	5	5	10	0	0	0	0	0				
12:15 PM	0	3	1	2	6	0	1	1	11	13	0	0	0	0	0				
12:30 PM	1	1	1	4	7	0	1	3	11	15	0	0	0	0	0				
12:45 PM	0	1	0	3	4	2	6	4	4	16	0	0	1	0	1				
1:00 PM	1	3	1	2	7	0	0	3	6	9	0	1	0	0	1				
1:15 PM	0	3	0	3	6	2	1	0	0	3	0	0	0	0	0				
1:30 PM	0	3	0	1	4	1	0	1	9	11	0	0	0	1	1				
1:45 PM	0	2	3	2	7	0	0	0	6	6	0	0	0	0	0				
2:00 PM	0	1	0	4	5	0	0	2	6	8	0	0	0	0	0				
2:15 PM	0	1	1	3	5	0	2	1	0	3	0	0	0	0	0				
2:30 PM	0	1	0	5	6	0	1	2	3	6	0	0	0	0	0				
2:45 PM	0	2	0	1	3	0	1	1	2	4	0	0	0	0	0				
3:00 PM	1	2	0	2	5	0	0	0	7	7	0	0	0	0	0				
3:15 PM	0	0	1	0	1	0	0	1	0	1	0	0	0	0	0				
3:30 PM	0	1	0	5	6	0	0	0	0	0	0	0	0	0	0				
3:45 PM	0	1	0	4	5	0	0	1	1	2	0	0	0	0	0				
4:00 PM	0	3	0	1	4	0	0	1	1	2	0	0	0	0	0				
4:15 PM	0	4	0	0	4	2	0	0	2	4	0	0	0	0	0				
4:30 PM	0	2	1	2	5	1	2	0	2	5	0	0	0	0	0				
4:45 PM	0	3	0	1	4	0	0	2	0	2	0	0	0	0	0				
5:00 PM	0	0	0	1	1	0	0	0	0	0	0	0	0	0	0				
5:15 PM	0	0	0	2	2	0	0	0	0	0	0	0	0	0	0				
5:30 PM	0	0	0	0	0	0	0	0	0	0	0	0	0	0	0				
5:45 PM	0	0	0	0	0	0	0	0	0	0	0	0	0	0	0				
Count Total	3	38	11	51	103	8	15	28	76	127	0	1	1	1	3				
Peak Hour	1	6	1	11	19	0	4	4	12	20	0	0	0	0	0				

A P P E N D I X B

HCM 6th AWSC
2: Silverado Trail & Deer Park Rd

02-11-2021

Intersection	
Intersection Delay, s/veh	76.7
Intersection LOS	F

Movement	EBL	EBT	EBR	WBL	WBT	WBR	NBL	NBT	NBR	SBL	SBT	SBR
Lane Configurations		↖	↗		↖	↗		↖	↗		↖	↗
Traffic Vol, veh/h	24	219	290	226	97	26	115	326	104	6	334	21
Future Vol, veh/h	24	219	290	226	97	26	115	326	104	6	334	21
Peak Hour Factor	0.94	0.94	0.94	0.94	0.94	0.94	0.94	0.94	0.94	0.94	0.94	0.94
Heavy Vehicles, %	0	0	2	0	0	0	0	1	0	0	0	0
Mvmt Flow	26	233	309	240	103	28	122	347	111	6	355	22
Number of Lanes	0	1	1	0	1	1	0	1	1	0	1	1

Approach	EB	WB	NB	SB
Opposing Approach	WB	EB	SB	NB
Opposing Lanes	2	2	2	2
Conflicting Approach Left	SB	NB	EB	WB
Conflicting Lanes Left	2	2	2	2
Conflicting Approach Right	NB	SB	WB	EB
Conflicting Lanes Right	2	2	2	2
HCM Control Delay	33.4	61.9	136.9	63.9
HCM LOS	D	F	F	F

Lane	NBLn1	NBLn2	EBLn1	EBLn2	WBLn1	WBLn2	SBLn1	SBLn2
Vol Left, %	26%	0%	10%	0%	70%	0%	2%	0%
Vol Thru, %	74%	0%	90%	0%	30%	0%	98%	0%
Vol Right, %	0%	100%	0%	100%	0%	100%	0%	100%
Sign Control	Stop	Stop	Stop	Stop	Stop	Stop	Stop	Stop
Traffic Vol by Lane	441	104	243	290	323	26	340	21
LT Vol	115	0	24	0	226	0	6	0
Through Vol	326	0	219	0	97	0	334	0
RT Vol	0	104	0	290	0	26	0	21
Lane Flow Rate	469	111	259	309	344	28	362	22
Geometry Grp	7	7	7	7	7	7	7	7
Degree of Util (X)	1.261	0.271	0.676	0.743	0.931	0.067	0.945	0.054
Departure Headway (Hd)	9.68	8.825	10.176	9.384	10.496	9.387	10.096	9.347
Convergence, Y/N	Yes	Yes	Yes	Yes	Yes	Yes	Yes	Yes
Cap	380	409	357	389	347	384	362	386
Service Time	7.38	6.525	7.876	7.084	8.196	7.087	7.796	7.047
HCM Lane V/C Ratio	1.234	0.271	0.725	0.794	0.991	0.073	1	0.057
HCM Control Delay	165.7	14.8	31.7	34.8	65.8	12.8	67.1	12.6
HCM Lane LOS	F	B	D	D	F	B	F	B
HCM 95th-tile Q	20.6	1.1	4.7	5.9	9.6	0.2	10.1	0.2

HCM 6th TWSC
 1: Silverado Trail & Crystal Springs Rd

02-11-2021

Intersection						
Int Delay, s/veh	0.5					
Movement	WBL	WBR	SEL	SET	NWT	NWR
Lane Configurations	T			T		T
Traffic Vol, veh/h	14	7	9	352	395	5
Future Vol, veh/h	14	7	9	352	395	5
Conflicting Peds, #/hr	0	0	0	0	0	0
Sign Control	Stop	Stop	Free	Free	Free	Free
RT Channelized	-	None	-	None	-	None
Storage Length	0	-	-	-	-	-
Veh in Median Storage, #	0	-	-	0	0	-
Grade, %	0	-	-	0	0	-
Peak Hour Factor	87	87	87	87	87	87
Heavy Vehicles, %	0	0	0	0	1	0
Mvmt Flow	16	8	10	405	454	6

Major/Minor	Minor2	Major1		Major2	
Conflicting Flow All	882	457	460	0	0
Stage 1	457	-	-	-	-
Stage 2	425	-	-	-	-
Critical Hdwy	6.4	6.2	4.1	-	-
Critical Hdwy Stg 1	5.4	-	-	-	-
Critical Hdwy Stg 2	5.4	-	-	-	-
Follow-up Hdwy	3.5	3.3	2.2	-	-
Pot Cap-1 Maneuver	319	608	1112	-	-
Stage 1	642	-	-	-	-
Stage 2	664	-	-	-	-
Platoon blocked, %				-	-
Mov Cap-1 Maneuver	315	608	1112	-	-
Mov Cap-2 Maneuver	315	-	-	-	-
Stage 1	634	-	-	-	-
Stage 2	664	-	-	-	-

Approach	WB	SE	NW
HCM Control Delay, s	15.3	0.2	0
HCM LOS	C		

Minor Lane/Major Mvmt	NWT	NWRWBLn1	SEL	SET
Capacity (veh/h)	-	-	375	1112
HCM Lane V/C Ratio	-	-	0.064	0.009
HCM Control Delay (s)	-	-	15.3	8.3
HCM Lane LOS	-	-	C	A
HCM 95th %tile Q(veh)	-	-	0.2	0

HCM 6th TWSC
6: Deer Park Rd & Sanitarium Rd

02-11-2021

Intersection						
Int Delay, s/veh	4					
Movement	EBL	EBR	NBL	NBT	SBT	SBR
Lane Configurations						
Traffic Vol, veh/h	1	163	120	210	186	1
Future Vol, veh/h	1	163	120	210	186	1
Conflicting Peds, #/hr	0	0	0	0	0	0
Sign Control	Stop	Stop	Free	Free	Free	Free
RT Channelized	-	Yield	-	None	-	None
Storage Length	55	0	100	-	-	-
Veh in Median Storage, #	0	-	-	0	0	-
Grade, %	0	-	-	0	0	-
Peak Hour Factor	88	88	88	88	88	88
Heavy Vehicles, %	0	4	2	3	6	0
Mvmt Flow	1	185	136	239	211	1

Major/Minor	Minor2	Major1		Major2	
Conflicting Flow All	723	212	212	0	0
Stage 1	212	-	-	-	-
Stage 2	511	-	-	-	-
Critical Hdwy	6.4	6.24	4.12	-	-
Critical Hdwy Stg 1	5.4	-	-	-	-
Critical Hdwy Stg 2	5.4	-	-	-	-
Follow-up Hdwy	3.5	3.336	2.218	-	-
Pot Cap-1 Maneuver	396	823	1358	-	-
Stage 1	828	-	-	-	-
Stage 2	606	-	-	-	-
Platoon blocked, %				-	-
Mov Cap-1 Maneuver	356	823	1358	-	-
Mov Cap-2 Maneuver	356	-	-	-	-
Stage 1	745	-	-	-	-
Stage 2	606	-	-	-	-

Approach	EB	NB	SB
HCM Control Delay, s	10.6	2.9	0
HCM LOS	B		

Minor Lane/Major Mvmt	NBL	NBT	EBLn1	EBLn2	SBT	SBR
Capacity (veh/h)	1358	-	356	823	-	-
HCM Lane V/C Ratio	0.1	-	0.003	0.225	-	-
HCM Control Delay (s)	7.9	-	15.1	10.6	-	-
HCM Lane LOS	A	-	C	B	-	-
HCM 95th %tile Q(veh)	0.3	-	0	0.9	-	-

HCM 6th TWSC
7: Sanitarium Rd & Crystal Springs Rd

02-11-2021

Intersection						
Int Delay, s/veh	0.7					
Movement	EBL	EBR	NBL	NBT	SBT	SBR
Lane Configurations	T		T		T	
Traffic Vol, veh/h	6	10	13	127	192	3
Future Vol, veh/h	6	10	13	127	192	3
Conflicting Peds, #/hr	0	0	0	0	0	0
Sign Control	Stop	Stop	Free	Free	Free	Free
RT Channelized	-	None	-	None	-	None
Storage Length	0	-	-	-	-	-
Veh in Median Storage, #	0	-	-	0	0	-
Grade, %	0	-	-	0	0	-
Peak Hour Factor	88	88	88	88	88	88
Heavy Vehicles, %	0	0	0	1	2	0
Mvmt Flow	7	11	15	144	218	3

Major/Minor	Minor2	Major1		Major2	
Conflicting Flow All	394	220	221	0	0
Stage 1	220	-	-	-	-
Stage 2	174	-	-	-	-
Critical Hdwy	6.4	6.2	4.1	-	-
Critical Hdwy Stg 1	5.4	-	-	-	-
Critical Hdwy Stg 2	5.4	-	-	-	-
Follow-up Hdwy	3.5	3.3	2.2	-	-
Pot Cap-1 Maneuver	615	825	1360	-	-
Stage 1	821	-	-	-	-
Stage 2	861	-	-	-	-
Platoon blocked, %				-	-
Mov Cap-1 Maneuver	608	825	1360	-	-
Mov Cap-2 Maneuver	608	-	-	-	-
Stage 1	811	-	-	-	-
Stage 2	861	-	-	-	-

Approach	EB	NB	SB
HCM Control Delay, s	10.1	0.7	0
HCM LOS	B		

Minor Lane/Major Mvmt	NBL	NBT	EBLn1	SBT	SBR
Capacity (veh/h)	1360	-	728	-	-
HCM Lane V/C Ratio	0.011	-	0.025	-	-
HCM Control Delay (s)	7.7	0	10.1	-	-
HCM Lane LOS	A	A	B	-	-
HCM 95th %tile Q(veh)	0	-	0.1	-	-

Intersection

Int Delay, s/veh 5

Movement	EBL	EBT	WBT	WBR	SBL	SBR
Lane Configurations		↕	↕		↕	
Traffic Vol, veh/h	6	8	6	1	3	15
Future Vol, veh/h	6	8	6	1	3	15
Conflicting Peds, #/hr	0	0	0	0	0	0
Sign Control	Free	Free	Free	Free	Stop	Stop
RT Channelized	-	None	-	None	-	None
Storage Length	-	-	-	-	0	-
Veh in Median Storage, #	-	0	0	-	0	-
Grade, %	-	0	0	-	0	-
Peak Hour Factor	80	80	80	80	80	80
Heavy Vehicles, %	0	0	0	0	0	0
Mvmt Flow	8	10	8	1	4	19

Major/Minor	Major1	Major2	Minor2
Conflicting Flow All	9	0	0 35 9
Stage 1	-	-	- - 9 -
Stage 2	-	-	- - 26 -
Critical Hdwy	4.1	-	- - 6.4 6.2
Critical Hdwy Stg 1	-	-	- - 5.4 -
Critical Hdwy Stg 2	-	-	- - 5.4 -
Follow-up Hdwy	2.2	-	- - 3.5 3.3
Pot Cap-1 Maneuver	1624	-	- - 983 1079
Stage 1	-	-	- - 1019 -
Stage 2	-	-	- - 1002 -
Platoon blocked, %		-	- - -
Mov Cap-1 Maneuver	1624	-	- - 978 1079
Mov Cap-2 Maneuver	-	-	- - 978 -
Stage 1	-	-	- - 1014 -
Stage 2	-	-	- - 1002 -

Approach	EB	WB	SB
HCM Control Delay, s	3.1	0	8.5
HCM LOS			A

Minor Lane/Major Mvmt	EBL	EBT	WBT	WBR	SBLn1
Capacity (veh/h)	1624	-	-	-	1061
HCM Lane V/C Ratio	0.005	-	-	-	0.021
HCM Control Delay (s)	7.2	0	-	-	8.5
HCM Lane LOS	A	A	-	-	A
HCM 95th %tile Q(veh)	0	-	-	-	0.1

HCM 6th AWSC
2: Silverado Trail & Deer Park Rd

02-11-2021

Intersection	
Intersection Delay, s/veh	46.2
Intersection LOS	E

Movement	EBL	EBT	EBR	WBL	WBT	WBR	NBL	NBT	NBR	SBL	SBT	SBR
Lane Configurations		↖	↗		↖	↗		↖	↗		↖	↗
Traffic Vol, veh/h	17	109	132	130	78	16	174	339	97	16	292	19
Future Vol, veh/h	17	109	132	130	78	16	174	339	97	16	292	19
Peak Hour Factor	0.97	0.97	0.97	0.97	0.97	0.97	0.97	0.97	0.97	0.97	0.97	0.97
Heavy Vehicles, %	0	0	2	0	0	0	0	1	0	0	0	0
Mvmt Flow	18	112	136	134	80	16	179	349	100	16	301	20
Number of Lanes	0	1	1	0	1	1	0	1	1	0	1	1

Approach	EB	WB	NB	SB
Opposing Approach	WB	EB	SB	NB
Opposing Lanes	2	2	2	2
Conflicting Approach Left	SB	NB	EB	WB
Conflicting Lanes Left	2	2	2	2
Conflicting Approach Right	NB	SB	WB	EB
Conflicting Lanes Right	2	2	2	2
HCM Control Delay	14.2	19.5	81.3	24.2
HCM LOS	B	C	F	C

Lane	NBLn1	NBLn2	EBLn1	EBLn2	WBLn1	WBLn2	SBLn1	SBLn2
Vol Left, %	34%	0%	13%	0%	62%	0%	5%	0%
Vol Thru, %	66%	0%	87%	0%	38%	0%	95%	0%
Vol Right, %	0%	100%	0%	100%	0%	100%	0%	100%
Sign Control	Stop	Stop	Stop	Stop	Stop	Stop	Stop	Stop
Traffic Vol by Lane	513	97	126	132	208	16	308	19
LT Vol	174	0	17	0	130	0	16	0
Through Vol	339	0	109	0	78	0	292	0
RT Vol	0	97	0	132	0	16	0	19
Lane Flow Rate	529	100	130	136	214	16	318	20
Geometry Grp	7	7	7	7	7	7	7	7
Degree of Util (X)	1.092	0.182	0.298	0.283	0.506	0.034	0.67	0.037
Departure Headway (Hd)	7.43	6.556	8.587	7.79	8.801	7.75	7.877	7.127
Convergence, Y/N	Yes	Yes	Yes	Yes	Yes	Yes	Yes	Yes
Cap	492	551	421	464	412	465	460	505
Service Time	5.13	4.256	6.287	5.49	6.501	5.45	5.577	4.827
HCM Lane V/C Ratio	1.075	0.181	0.309	0.293	0.519	0.034	0.691	0.04
HCM Control Delay	94.7	10.7	14.9	13.5	20.2	10.7	25.1	10.1
HCM Lane LOS	F	B	B	B	C	B	D	B
HCM 95th-tile Q	17.1	0.7	1.2	1.2	2.8	0.1	4.8	0.1

HCM 6th TWSC
 1: Silverado Trail & Crystal Springs Rd

02-11-2021

Intersection						
Int Delay, s/veh	0.3					
Movement	WBL	WBR	SEL	SET	NWT	NWR
Lane Configurations	T			T		
Traffic Vol, veh/h	8	4	6	288	365	0
Future Vol, veh/h	8	4	6	288	365	0
Conflicting Peds, #/hr	0	0	0	0	0	0
Sign Control	Stop	Stop	Free	Free	Free	Free
RT Channelized	-	None	-	None	-	None
Storage Length	0	-	-	-	-	-
Veh in Median Storage, #	0	-	-	0	0	-
Grade, %	0	-	-	0	0	-
Peak Hour Factor	95	95	95	95	95	95
Heavy Vehicles, %	0	0	0	0	1	0
Mvmt Flow	8	4	6	303	384	0

Major/Minor	Minor2	Major1	Major2			
Conflicting Flow All	699	384	384	0	-	0
Stage 1	384	-	-	-	-	-
Stage 2	315	-	-	-	-	-
Critical Hdwy	6.4	6.2	4.1	-	-	-
Critical Hdwy Stg 1	5.4	-	-	-	-	-
Critical Hdwy Stg 2	5.4	-	-	-	-	-
Follow-up Hdwy	3.5	3.3	2.2	-	-	-
Pot Cap-1 Maneuver	409	668	1186	-	-	-
Stage 1	693	-	-	-	-	-
Stage 2	744	-	-	-	-	-
Platoon blocked, %				-	-	-
Mov Cap-1 Maneuver	407	668	1186	-	-	-
Mov Cap-2 Maneuver	407	-	-	-	-	-
Stage 1	689	-	-	-	-	-
Stage 2	744	-	-	-	-	-

Approach	WB	SE	NW
HCM Control Delay, s	12.9	0.2	0
HCM LOS	B		

Minor Lane/Major Mvmt	NWT	NWRWBLn1	SEL	SET
Capacity (veh/h)	-	-	468	1186
HCM Lane V/C Ratio	-	-	0.027	0.005
HCM Control Delay (s)	-	-	12.9	8.1
HCM Lane LOS	-	-	B	A
HCM 95th %tile Q(veh)	-	-	0.1	0

Intersection						
Int Delay, s/veh	3.1					
Movement	EBL	EBR	NBL	NBT	SBT	SBR
Lane Configurations						
Traffic Vol, veh/h	1	83	79	143	141	1
Future Vol, veh/h	1	83	79	143	141	1
Conflicting Peds, #/hr	0	0	0	0	0	0
Sign Control	Stop	Stop	Free	Free	Free	Free
RT Channelized	-	None	-	None	-	None
Storage Length	50	0	50	-	-	-
Veh in Median Storage, #	0	-	-	0	0	-
Grade, %	0	-	-	0	0	-
Peak Hour Factor	92	92	92	92	92	92
Heavy Vehicles, %	0	1	1	3	7	2
Mvmt Flow	1	90	86	155	153	1

Major/Minor	Minor2	Major1	Major2			
Conflicting Flow All	481	154	154	0	-	0
Stage 1	154	-	-	-	-	-
Stage 2	327	-	-	-	-	-
Critical Hdwy	6.4	6.21	4.11	-	-	-
Critical Hdwy Stg 1	5.4	-	-	-	-	-
Critical Hdwy Stg 2	5.4	-	-	-	-	-
Follow-up Hdwy	3.5	3.309	2.209	-	-	-
Pot Cap-1 Maneuver	548	895	1433	-	-	-
Stage 1	879	-	-	-	-	-
Stage 2	735	-	-	-	-	-
Platoon blocked, %				-	-	-
Mov Cap-1 Maneuver	515	895	1433	-	-	-
Mov Cap-2 Maneuver	515	-	-	-	-	-
Stage 1	826	-	-	-	-	-
Stage 2	735	-	-	-	-	-

Approach	EB	NB	SB
HCM Control Delay, s	9.5	2.7	0
HCM LOS	A		

Minor Lane/Major Mvmt	NBL	NBT	EBLn1	EBLn2	SBT	SBR
Capacity (veh/h)	1433	-	515	895	-	-
HCM Lane V/C Ratio	0.06	-	0.002	0.101	-	-
HCM Control Delay (s)	7.7	-	12	9.5	-	-
HCM Lane LOS	A	-	B	A	-	-
HCM 95th %tile Q(veh)	0.2	-	0	0.3	-	-

HCM 6th TWSC
7: Sanitarium Rd & Crystal Springs Rd

02-11-2021

Intersection						
Int Delay, s/veh	1					
Movement	EBL	EBR	NBL	NBT	SBT	SBR
Lane Configurations						
Traffic Vol, veh/h	6	8	9	79	103	3
Future Vol, veh/h	6	8	9	79	103	3
Conflicting Peds, #/hr	0	0	0	0	0	0
Sign Control	Stop	Stop	Free	Free	Free	Free
RT Channelized	-	None	-	None	-	None
Storage Length	0	-	-	-	-	-
Veh in Median Storage, #	0	-	-	0	0	-
Grade, %	0	-	-	0	0	-
Peak Hour Factor	85	85	85	85	85	85
Heavy Vehicles, %	0	0	0	6	3	0
Mvmt Flow	7	9	11	93	121	4

Major/Minor	Minor2	Major1		Major2	
Conflicting Flow All	238	123	125	0	0
Stage 1	123	-	-	-	-
Stage 2	115	-	-	-	-
Critical Hdwy	6.4	6.2	4.1	-	-
Critical Hdwy Stg 1	5.4	-	-	-	-
Critical Hdwy Stg 2	5.4	-	-	-	-
Follow-up Hdwy	3.5	3.3	2.2	-	-
Pot Cap-1 Maneuver	755	933	1474	-	-
Stage 1	907	-	-	-	-
Stage 2	915	-	-	-	-
Platoon blocked, %				-	-
Mov Cap-1 Maneuver	749	933	1474	-	-
Mov Cap-2 Maneuver	749	-	-	-	-
Stage 1	900	-	-	-	-
Stage 2	915	-	-	-	-

Approach	EB	NB	SB
HCM Control Delay, s	9.4	0.8	0
HCM LOS	A		

Minor Lane/Major Mvmt	NBL	NBT	EBLn1	SBT	SBR
Capacity (veh/h)	1474	-	844	-	-
HCM Lane V/C Ratio	0.007	-	0.02	-	-
HCM Control Delay (s)	7.5	0	9.4	-	-
HCM Lane LOS	A	A	A	-	-
HCM 95th %tile Q(veh)	0	-	0.1	-	-

Intersection						
Int Delay, s/veh	3.1					
Movement	EBL	EBT	WBT	WBR	SBL	SBR
Lane Configurations		↶	↷		↶	
Traffic Vol, veh/h	3	3	8	0	0	4
Future Vol, veh/h	3	3	8	0	0	4
Conflicting Peds, #/hr	0	0	0	0	0	0
Sign Control	Free	Free	Free	Free	Stop	Stop
RT Channelized	-	None	-	None	-	None
Storage Length	-	-	-	-	0	-
Veh in Median Storage, #	-	0	0	-	0	-
Grade, %	-	0	0	-	0	-
Peak Hour Factor	80	80	80	80	80	80
Heavy Vehicles, %	2	2	2	2	2	2
Mvmt Flow	4	4	10	0	0	5

Major/Minor	Major1	Major2	Minor2		
Conflicting Flow All	10	0	-	0	22 10
Stage 1	-	-	-	-	10 -
Stage 2	-	-	-	-	12 -
Critical Hdwy	4.12	-	-	-	6.42 6.22
Critical Hdwy Stg 1	-	-	-	-	5.42 -
Critical Hdwy Stg 2	-	-	-	-	5.42 -
Follow-up Hdwy	2.218	-	-	-	3.518 3.318
Pot Cap-1 Maneuver	1610	-	-	-	995 1071
Stage 1	-	-	-	-	1013 -
Stage 2	-	-	-	-	1011 -
Platoon blocked, %		-	-	-	
Mov Cap-1 Maneuver	1610	-	-	-	993 1071
Mov Cap-2 Maneuver	-	-	-	-	993 -
Stage 1	-	-	-	-	1011 -
Stage 2	-	-	-	-	1011 -

Approach	EB	WB	SB
HCM Control Delay, s	3.6	0	8.4
HCM LOS			A

Minor Lane/Major Mvmt	EBL	EBT	WBT	WBR	SBLn1
Capacity (veh/h)	1610	-	-	-	1071
HCM Lane V/C Ratio	0.002	-	-	-	0.005
HCM Control Delay (s)	7.2	0	-	-	8.4
HCM Lane LOS	A	A	-	-	A
HCM 95th %tile Q(veh)	0	-	-	-	0

HCM 6th AWSC
2: Silverado Trail & Deer Park Rd

03-26-2021

Intersection	
Intersection Delay, s/veh	110.2
Intersection LOS	F

Movement	EBL	EBT	EBR	WBL	WBT	WBR	NBL	NBT	NBR	SBL	SBT	SBR
Lane Configurations		↖	↗		↖	↗		↖	↗		↖	↗
Traffic Vol, veh/h	25	232	317	240	105	28	125	371	109	8	374	24
Future Vol, veh/h	25	232	317	240	105	28	125	371	109	8	374	24
Peak Hour Factor	0.94	0.94	0.94	0.94	0.94	0.94	0.94	0.94	0.94	0.94	0.94	0.94
Heavy Vehicles, %	0	0	2	0	0	0	0	1	0	0	0	0
Mvmt Flow	27	247	337	255	112	30	133	395	116	9	398	26
Number of Lanes	0	1	1	0	1	1	0	1	1	0	1	1

Approach	EB	WB	NB	SB
Opposing Approach	WB	EB	SB	NB
Opposing Lanes	2	2	2	2
Conflicting Approach Left	SB	NB	EB	WB
Conflicting Lanes Left	2	2	2	2
Conflicting Approach Right	NB	SB	WB	EB
Conflicting Lanes Right	2	2	2	2
HCM Control Delay	44.2	81.9	194.9	103.5
HCM LOS	E	F	F	F

Lane	NBLn1	NBLn2	EBLn1	EBLn2	WBLn1	WBLn2	SBLn1	SBLn2
Vol Left, %	25%	0%	10%	0%	70%	0%	2%	0%
Vol Thru, %	75%	0%	90%	0%	30%	0%	98%	0%
Vol Right, %	0%	100%	0%	100%	0%	100%	0%	100%
Sign Control	Stop	Stop	Stop	Stop	Stop	Stop	Stop	Stop
Traffic Vol by Lane	496	109	257	317	345	28	382	24
LT Vol	125	0	25	0	240	0	8	0
Through Vol	371	0	232	0	105	0	374	0
RT Vol	0	109	0	317	0	28	0	24
Lane Flow Rate	528	116	273	337	367	30	406	26
Geometry Grp	7	7	7	7	7	7	7	7
Degree of Util (X)	1.426	0.287	0.74	0.842	1.011	0.073	1.092	0.064
Departure Headway (Hd)	10.213	9.358	10.876	10.079	11.107	9.992	10.617	9.863
Convergence, Y/N	Yes	Yes	Yes	Yes	Yes	Yes	Yes	Yes
Cap	359	386	336	361	330	361	345	365
Service Time	7.913	7.058	8.576	7.779	8.807	7.692	8.317	7.563
HCM Lane V/C Ratio	1.471	0.301	0.813	0.934	1.112	0.083	1.177	0.071
HCM Control Delay	234.2	15.8	39	48.5	87.4	13.5	109.2	13.2
HCM Lane LOS	F	C	E	E	F	B	F	B
HCM 95th-tile Q	26	1.2	5.6	7.7	11.3	0.2	13.9	0.2

HCM 6th TWSC
 1: Silverado Trail & Crystal Springs Rd

03-26-2021

Intersection						
Int Delay, s/veh	0.5					
Movement	WBL	WBR	SEL	SET	NWT	NWR
Lane Configurations	T			T		
Traffic Vol, veh/h	15	8	9	355	405	6
Future Vol, veh/h	15	8	9	355	405	6
Conflicting Peds, #/hr	0	0	0	0	0	0
Sign Control	Stop	Stop	Free	Free	Free	Free
RT Channelized	-	None	-	None	-	None
Storage Length	0	-	-	-	-	-
Veh in Median Storage, #	0	-	-	0	0	-
Grade, %	0	-	-	0	0	-
Peak Hour Factor	87	87	87	87	87	87
Heavy Vehicles, %	0	0	0	0	1	0
Mvmt Flow	17	9	10	408	466	7

Major/Minor	Minor2	Major1		Major2	
Conflicting Flow All	898	470	473	0	0
Stage 1	470	-	-	-	-
Stage 2	428	-	-	-	-
Critical Hdwy	6.4	6.2	4.1	-	-
Critical Hdwy Stg 1	5.4	-	-	-	-
Critical Hdwy Stg 2	5.4	-	-	-	-
Follow-up Hdwy	3.5	3.3	2.2	-	-
Pot Cap-1 Maneuver	312	598	1099	-	-
Stage 1	633	-	-	-	-
Stage 2	662	-	-	-	-
Platoon blocked, %				-	-
Mov Cap-1 Maneuver	308	598	1099	-	-
Mov Cap-2 Maneuver	308	-	-	-	-
Stage 1	625	-	-	-	-
Stage 2	662	-	-	-	-

Approach	WB	SE	NW
HCM Control Delay, s	15.5	0.2	0
HCM LOS	C		

Minor Lane/Major Mvmt	NWT	NWRWBLn1	SEL	SET
Capacity (veh/h)	-	-	370	1099
HCM Lane V/C Ratio	-	-	0.071	0.009
HCM Control Delay (s)	-	-	15.5	8.3
HCM Lane LOS	-	-	C	A
HCM 95th %tile Q(veh)	-	-	0.2	0

Intersection						
Int Delay, s/veh	4.1					
Movement	EBL	EBR	NBL	NBT	SBT	SBR
Lane Configurations	↙	↗	↙	↑	↗	
Traffic Vol, veh/h	2	175	127	222	198	2
Future Vol, veh/h	2	175	127	222	198	2
Conflicting Peds, #/hr	0	0	0	0	0	0
Sign Control	Stop	Stop	Free	Free	Free	Free
RT Channelized	-	Yield	-	None	-	None
Storage Length	55	0	100	-	-	-
Veh in Median Storage, #	0	-	-	0	0	-
Grade, %	0	-	-	0	0	-
Peak Hour Factor	88	88	88	88	88	88
Heavy Vehicles, %	0	4	2	3	6	0
Mvmt Flow	2	199	144	252	225	2

Major/Minor	Minor2	Major1	Major2			
Conflicting Flow All	766	226	227	0	-	0
Stage 1	226	-	-	-	-	-
Stage 2	540	-	-	-	-	-
Critical Hdwy	6.4	6.24	4.12	-	-	-
Critical Hdwy Stg 1	5.4	-	-	-	-	-
Critical Hdwy Stg 2	5.4	-	-	-	-	-
Follow-up Hdwy	3.5	3.336	2.218	-	-	-
Pot Cap-1 Maneuver	374	808	1341	-	-	-
Stage 1	816	-	-	-	-	-
Stage 2	588	-	-	-	-	-
Platoon blocked, %				-	-	-
Mov Cap-1 Maneuver	334	808	1341	-	-	-
Mov Cap-2 Maneuver	334	-	-	-	-	-
Stage 1	729	-	-	-	-	-
Stage 2	588	-	-	-	-	-

Approach	EB	NB	SB
HCM Control Delay, s	11	2.9	0
HCM LOS	B		

Minor Lane/Major Mvmt	NBL	NBT	EBLn1	EBLn2	SBT	SBR
Capacity (veh/h)	1341	-	334	808	-	-
HCM Lane V/C Ratio	0.108	-	0.007	0.246	-	-
HCM Control Delay (s)	8	-	15.9	10.9	-	-
HCM Lane LOS	A	-	C	B	-	-
HCM 95th %tile Q(veh)	0.4	-	0	1	-	-

HCM 6th TWSC
7: Sanitarium Rd & Crystal Springs Rd

03-26-2021

Intersection						
Int Delay, s/veh	0.8					
Movement	EBL	EBR	NBL	NBT	SBT	SBR
Lane Configurations						
Traffic Vol, veh/h	7	11	14	136	206	4
Future Vol, veh/h	7	11	14	136	206	4
Conflicting Peds, #/hr	0	0	0	0	0	0
Sign Control	Stop	Stop	Free	Free	Free	Free
RT Channelized	-	None	-	None	-	None
Storage Length	0	-	-	-	-	-
Veh in Median Storage, #	0	-	-	0	0	-
Grade, %	0	-	-	0	0	-
Peak Hour Factor	88	88	88	88	88	88
Heavy Vehicles, %	0	0	0	1	2	0
Mvmt Flow	8	13	16	155	234	5

Major/Minor	Minor2	Major1	Major2			
Conflicting Flow All	424	237	239	0	-	0
Stage 1	237	-	-	-	-	-
Stage 2	187	-	-	-	-	-
Critical Hdwy	6.4	6.2	4.1	-	-	-
Critical Hdwy Stg 1	5.4	-	-	-	-	-
Critical Hdwy Stg 2	5.4	-	-	-	-	-
Follow-up Hdwy	3.5	3.3	2.2	-	-	-
Pot Cap-1 Maneuver	591	807	1340	-	-	-
Stage 1	807	-	-	-	-	-
Stage 2	850	-	-	-	-	-
Platoon blocked, %				-	-	-
Mov Cap-1 Maneuver	583	807	1340	-	-	-
Mov Cap-2 Maneuver	583	-	-	-	-	-
Stage 1	797	-	-	-	-	-
Stage 2	850	-	-	-	-	-

Approach	EB	NB	SB
HCM Control Delay, s	10.3	0.7	0
HCM LOS	B		

Minor Lane/Major Mvmt	NBL	NBT	EBLn1	SBT	SBR
Capacity (veh/h)	1340	-	702	-	-
HCM Lane V/C Ratio	0.012	-	0.029	-	-
HCM Control Delay (s)	7.7	0	10.3	-	-
HCM Lane LOS	A	A	B	-	-
HCM 95th %tile Q(veh)	0	-	0.1	-	-

HCM 6th TWSC
 10: Crystal Springs Rd & Crystal Springs North

03-26-2021

Intersection						
Int Delay, s/veh	4.9					
Movement	EBL	EBT	WBT	WBR	SBL	SBR
Lane Configurations		↕	↕		↕	
Traffic Vol, veh/h	6	9	7	1	3	16
Future Vol, veh/h	6	9	7	1	3	16
Conflicting Peds, #/hr	0	0	0	0	0	0
Sign Control	Free	Free	Free	Free	Stop	Stop
RT Channelized	-	None	-	None	-	None
Storage Length	-	-	-	-	0	-
Veh in Median Storage, #	-	0	0	-	0	-
Grade, %	-	0	0	-	0	-
Peak Hour Factor	92	92	92	92	92	92
Heavy Vehicles, %	2	2	2	2	2	2
Mvmt Flow	7	10	8	1	3	17

Major/Minor	Major1	Major2	Minor2		
Conflicting Flow All	9	0	-	0	33
Stage 1	-	-	-	-	9
Stage 2	-	-	-	-	24
Critical Hdwy	4.12	-	-	-	6.42
Critical Hdwy Stg 1	-	-	-	-	5.42
Critical Hdwy Stg 2	-	-	-	-	5.42
Follow-up Hdwy	2.218	-	-	-	3.518
Pot Cap-1 Maneuver	1611	-	-	-	980
Stage 1	-	-	-	-	1014
Stage 2	-	-	-	-	999
Platoon blocked, %		-	-	-	
Mov Cap-1 Maneuver	1611	-	-	-	976
Mov Cap-2 Maneuver	-	-	-	-	976
Stage 1	-	-	-	-	1010
Stage 2	-	-	-	-	999

Approach	EB	WB	SB
HCM Control Delay, s	2.9	0	8.5
HCM LOS			A

Minor Lane/Major Mvmt	EBL	EBT	WBT	WBR	SBLn1
Capacity (veh/h)	1611	-	-	-	1056
HCM Lane V/C Ratio	0.004	-	-	-	0.02
HCM Control Delay (s)	7.2	0	-	-	8.5
HCM Lane LOS	A	A	-	-	A
HCM 95th %tile Q(veh)	0	-	-	-	0.1

HCM 6th AWSC
2: Silverado Trail & Deer Park Rd

03-26-2021

Intersection	
Intersection Delay, s/veh	72.3
Intersection LOS	F

Movement	EBL	EBT	EBR	WBL	WBT	WBR	NBL	NBT	NBR	SBL	SBT	SBR
Lane Configurations		↖	↗		↖	↗		↖	↗		↖	↗
Traffic Vol, veh/h	19	116	143	136	84	18	189	381	103	18	331	21
Future Vol, veh/h	19	116	143	136	84	18	189	381	103	18	331	21
Peak Hour Factor	0.97	0.97	0.97	0.97	0.97	0.97	0.97	0.97	0.97	0.97	0.97	0.97
Heavy Vehicles, %	0	0	2	0	0	0	0	1	0	0	0	0
Mvmt Flow	20	120	147	140	87	19	195	393	106	19	341	22
Number of Lanes	0	1	1	0	1	1	0	1	1	0	1	1

Approach	EB	WB	NB	SB
Opposing Approach	WB	EB	SB	NB
Opposing Lanes	2	2	2	2
Conflicting Approach Left	SB	NB	EB	WB
Conflicting Lanes Left	2	2	2	2
Conflicting Approach Right	NB	SB	WB	EB
Conflicting Lanes Right	2	2	2	2
HCM Control Delay	15.4	21.6	135.6	32.5
HCM LOS	C	C	F	D

Lane	NBLn1	NBLn2	EBLn1	EBLn2	WBLn1	WBLn2	SBLn1	SBLn2
Vol Left, %	33%	0%	14%	0%	62%	0%	5%	0%
Vol Thru, %	67%	0%	86%	0%	38%	0%	95%	0%
Vol Right, %	0%	100%	0%	100%	0%	100%	0%	100%
Sign Control	Stop	Stop	Stop	Stop	Stop	Stop	Stop	Stop
Traffic Vol by Lane	570	103	135	143	220	18	349	21
LT Vol	189	0	19	0	136	0	18	0
Through Vol	381	0	116	0	84	0	331	0
RT Vol	0	103	0	143	0	18	0	21
Lane Flow Rate	588	106	139	147	227	19	360	22
Geometry Grp	7	7	7	7	7	7	7	7
Degree of Util (X)	1.262	0.202	0.324	0.316	0.541	0.039	0.771	0.042
Departure Headway (Hd)	7.729	6.855	9.095	8.29	9.307	8.253	8.271	7.518
Convergence, Y/N	Yes	Yes	Yes	Yes	Yes	Yes	Yes	Yes
Cap	476	527	398	436	390	436	439	479
Service Time	5.435	4.562	6.795	5.99	7.007	5.953	5.971	5.218
HCM Lane V/C Ratio	1.235	0.201	0.349	0.337	0.582	0.044	0.82	0.046
HCM Control Delay	158.1	11.3	16.1	14.8	22.4	11.3	33.8	10.5
HCM Lane LOS	F	B	C	B	C	B	D	B
HCM 95th-tile Q	24.3	0.7	1.4	1.3	3.1	0.1	6.6	0.1

HCM 6th TWSC
 1: Silverado Trail & Crystal Springs Rd

03-26-2021

Intersection						
Int Delay, s/veh	0.3					
Movement	WBL	WBR	SEL	SET	NWT	NWR
Lane Configurations	T			L		R
Traffic Vol, veh/h	8	5	7	325	403	1
Future Vol, veh/h	8	5	7	325	403	1
Conflicting Peds, #/hr	0	0	0	0	0	0
Sign Control	Stop	Stop	Free	Free	Free	Free
RT Channelized	-	None	-	None	-	None
Storage Length	0	-	-	-	-	-
Veh in Median Storage, #	0	-	-	0	0	-
Grade, %	0	-	-	0	0	-
Peak Hour Factor	95	95	95	95	95	95
Heavy Vehicles, %	0	0	0	0	1	0
Mvmt Flow	8	5	7	342	424	1

Major/Minor	Minor2	Major1		Major2	
Conflicting Flow All	781	425	425	0	- 0
Stage 1	425	-	-	-	-
Stage 2	356	-	-	-	-
Critical Hdwy	6.4	6.2	4.1	-	-
Critical Hdwy Stg 1	5.4	-	-	-	-
Critical Hdwy Stg 2	5.4	-	-	-	-
Follow-up Hdwy	3.5	3.3	2.2	-	-
Pot Cap-1 Maneuver	366	634	1145	-	-
Stage 1	664	-	-	-	-
Stage 2	713	-	-	-	-
Platoon blocked, %				-	-
Mov Cap-1 Maneuver	363	634	1145	-	-
Mov Cap-2 Maneuver	363	-	-	-	-
Stage 1	659	-	-	-	-
Stage 2	713	-	-	-	-

Approach	WB	SE	NW
HCM Control Delay, s	13.6	0.2	0
HCM LOS	B		

Minor Lane/Major Mvmt	NWT	NWRWBLn1	SEL	SET
Capacity (veh/h)	-	-	434	1145
HCM Lane V/C Ratio	-	-	0.032	0.006
HCM Control Delay (s)	-	-	13.6	8.2
HCM Lane LOS	-	-	B	A
HCM 95th %tile Q(veh)	-	-	0.1	0

HCM 6th TWSC
6: Deer Park Rd & Sanitarium Rd

03-26-2021

Intersection						
Int Delay, s/veh	3.2					
Movement	EBL	EBR	NBL	NBT	SBT	SBR
Lane Configurations						
Traffic Vol, veh/h	2	88	84	153	150	2
Future Vol, veh/h	2	88	84	153	150	2
Conflicting Peds, #/hr	0	0	0	0	0	0
Sign Control	Stop	Stop	Free	Free	Free	Free
RT Channelized	-	None	-	None	-	None
Storage Length	50	0	50	-	-	-
Veh in Median Storage, #	0	-	-	0	0	-
Grade, %	0	-	-	0	0	-
Peak Hour Factor	92	92	92	92	92	92
Heavy Vehicles, %	0	1	1	3	7	2
Mvmt Flow	2	96	91	166	163	2

Major/Minor	Minor2	Major1	Major2			
Conflicting Flow All	512	164	165	0	-	0
Stage 1	164	-	-	-	-	-
Stage 2	348	-	-	-	-	-
Critical Hdwy	6.4	6.21	4.11	-	-	-
Critical Hdwy Stg 1	5.4	-	-	-	-	-
Critical Hdwy Stg 2	5.4	-	-	-	-	-
Follow-up Hdwy	3.5	3.309	2.209	-	-	-
Pot Cap-1 Maneuver	525	883	1419	-	-	-
Stage 1	870	-	-	-	-	-
Stage 2	719	-	-	-	-	-
Platoon blocked, %				-	-	-
Mov Cap-1 Maneuver	491	883	1419	-	-	-
Mov Cap-2 Maneuver	491	-	-	-	-	-
Stage 1	814	-	-	-	-	-
Stage 2	719	-	-	-	-	-

Approach	EB	NB	SB
HCM Control Delay, s	9.7	2.7	0
HCM LOS	A		

Minor Lane/Major Mvmt	NBL	NBT	EBLn1	EBLn2	SBT	SBR
Capacity (veh/h)	1419	-	491	883	-	-
HCM Lane V/C Ratio	0.064	-	0.004	0.108	-	-
HCM Control Delay (s)	7.7	-	12.4	9.6	-	-
HCM Lane LOS	A	-	B	A	-	-
HCM 95th %tile Q(veh)	0.2	-	0	0.4	-	-

HCM 6th TWSC
7: Sanitarium Rd & Crystal Springs Rd

03-26-2021

Intersection						
Int Delay, s/veh	1					
Movement	EBL	EBR	NBL	NBT	SBT	SBR
Lane Configurations						
Traffic Vol, veh/h	7	9	10	85	109	4
Future Vol, veh/h	7	9	10	85	109	4
Conflicting Peds, #/hr	0	0	0	0	0	0
Sign Control	Stop	Stop	Free	Free	Free	Free
RT Channelized	-	None	-	None	-	None
Storage Length	0	-	-	-	-	-
Veh in Median Storage, #	0	-	-	0	0	-
Grade, %	0	-	-	0	0	-
Peak Hour Factor	85	85	85	85	85	85
Heavy Vehicles, %	0	0	0	6	3	0
Mvmt Flow	8	11	12	100	128	5

Major/Minor	Minor2	Major1		Major2	
Conflicting Flow All	255	131	133	0	0
Stage 1	131	-	-	-	-
Stage 2	124	-	-	-	-
Critical Hdwy	6.4	6.2	4.1	-	-
Critical Hdwy Stg 1	5.4	-	-	-	-
Critical Hdwy Stg 2	5.4	-	-	-	-
Follow-up Hdwy	3.5	3.3	2.2	-	-
Pot Cap-1 Maneuver	738	924	1464	-	-
Stage 1	900	-	-	-	-
Stage 2	907	-	-	-	-
Platoon blocked, %				-	-
Mov Cap-1 Maneuver	731	924	1464	-	-
Mov Cap-2 Maneuver	731	-	-	-	-
Stage 1	892	-	-	-	-
Stage 2	907	-	-	-	-

Approach	EB	NB	SB
HCM Control Delay, s	9.4	0.8	0
HCM LOS	A		

Minor Lane/Major Mvmt	NBL	NBT	EBLn1	SBT	SBR
Capacity (veh/h)	1464	-	828	-	-
HCM Lane V/C Ratio	0.008	-	0.023	-	-
HCM Control Delay (s)	7.5	0	9.4	-	-
HCM Lane LOS	A	A	A	-	-
HCM 95th %tile Q(veh)	0	-	0.1	-	-

Intersection						
Int Delay, s/veh	3.4					
Movement	EBL	EBT	WBT	WBR	SBL	SBR
Lane Configurations		↶	↷		↶	
Traffic Vol, veh/h	4	4	8	0	0	5
Future Vol, veh/h	4	4	8	0	0	5
Conflicting Peds, #/hr	0	0	0	0	0	0
Sign Control	Free	Free	Free	Free	Stop	Stop
RT Channelized	-	None	-	None	-	None
Storage Length	-	-	-	-	0	-
Veh in Median Storage, #	-	0	0	-	0	-
Grade, %	-	0	0	-	0	-
Peak Hour Factor	80	80	80	80	80	80
Heavy Vehicles, %	2	2	2	2	2	2
Mvmt Flow	5	5	10	0	0	6

Major/Minor	Major1	Major2	Minor2		
Conflicting Flow All	10	0	-	0	25 10
Stage 1	-	-	-	-	10 -
Stage 2	-	-	-	-	15 -
Critical Hdwy	4.12	-	-	-	6.42 6.22
Critical Hdwy Stg 1	-	-	-	-	5.42 -
Critical Hdwy Stg 2	-	-	-	-	5.42 -
Follow-up Hdwy	2.218	-	-	-	3.518 3.318
Pot Cap-1 Maneuver	1610	-	-	-	991 1071
Stage 1	-	-	-	-	1013 -
Stage 2	-	-	-	-	1008 -
Platoon blocked, %		-	-	-	
Mov Cap-1 Maneuver	1610	-	-	-	988 1071
Mov Cap-2 Maneuver	-	-	-	-	988 -
Stage 1	-	-	-	-	1010 -
Stage 2	-	-	-	-	1008 -

Approach	EB	WB	SB
HCM Control Delay, s	3.6	0	8.4
HCM LOS			A

Minor Lane/Major Mvmt	EBL	EBT	WBT	WBR	SBLn1
Capacity (veh/h)	1610	-	-	-	1071
HCM Lane V/C Ratio	0.003	-	-	-	0.006
HCM Control Delay (s)	7.2	0	-	-	8.4
HCM Lane LOS	A	A	-	-	A
HCM 95th %tile Q(veh)	0	-	-	-	0

HCM 6th AWSC
2: Silverado Trail & Deer Park Rd

03-26-2021

Intersection	
Intersection Delay, s/veh	144.9
Intersection LOS	F

Movement	EBL	EBT	EBR	WBL	WBT	WBR	NBL	NBT	NBR	SBL	SBT	SBR
Lane Configurations		↖	↗		↖	↗		↖	↗		↖	↗
Traffic Vol, veh/h	30	240	345	255	110	30	135	415	115	10	415	25
Future Vol, veh/h	30	240	345	255	110	30	135	415	115	10	415	25
Peak Hour Factor	0.94	0.94	0.94	0.94	0.94	0.94	0.94	0.94	0.94	0.94	0.94	0.94
Heavy Vehicles, %	0	0	2	0	0	0	0	1	0	0	0	0
Mvmt Flow	32	255	367	271	117	32	144	441	122	11	441	27
Number of Lanes	0	1	1	0	1	1	0	1	1	0	1	1

Approach	EB	WB	NB	SB
Opposing Approach	WB	EB	SB	NB
Opposing Lanes	2	2	2	2
Conflicting Approach Left	SB	NB	EB	WB
Conflicting Lanes Left	2	2	2	2
Conflicting Approach Right	NB	SB	WB	EB
Conflicting Lanes Right	2	2	2	2
HCM Control Delay	55.5	102.3	252.2	145.9
HCM LOS	F	F	F	F

Lane	NBLn1	NBLn2	EBLn1	EBLn2	WBLn1	WBLn2	SBLn1	SBLn2
Vol Left, %	25%	0%	11%	0%	70%	0%	2%	0%
Vol Thru, %	75%	0%	89%	0%	30%	0%	98%	0%
Vol Right, %	0%	100%	0%	100%	0%	100%	0%	100%
Sign Control	Stop	Stop	Stop	Stop	Stop	Stop	Stop	Stop
Traffic Vol by Lane	550	115	270	345	365	30	425	25
LT Vol	135	0	30	0	255	0	10	0
Through Vol	415	0	240	0	110	0	415	0
RT Vol	0	115	0	345	0	30	0	25
Lane Flow Rate	585	122	287	367	388	32	452	27
Geometry Grp	7	7	7	7	7	7	7	7
Degree of Util (X)	1.582	0.303	0.778	0.917	1.08	0.079	1.215	0.066
Departure Headway (Hd)	10.645	9.789	11.5	10.691	11.6	10.478	11.053	10.294
Convergence, Y/N	Yes	Yes	Yes	Yes	Yes	Yes	Yes	Yes
Cap	345	369	316	341	315	344	335	350
Service Time	8.345	7.489	9.2	8.391	9.3	8.178	8.753	7.994
HCM Lane V/C Ratio	1.696	0.331	0.908	1.076	1.232	0.093	1.349	0.077
HCM Control Delay	301.5	16.7	45	63.7	109.5	14.1	153.7	13.7
HCM Lane LOS	F	C	E	F	F	B	F	B
HCM 95th-tile Q	31.1	1.3	6.2	9.2	12.9	0.3	17.3	0.2

HCM 6th TWSC
 1: Silverado Trail & Crystal Springs Rd

03-26-2021

Intersection						
Int Delay, s/veh	0.6					
Movement	WBL	WBR	SEL	SET	NWT	NWR
Lane Configurations	T			L		R
Traffic Vol, veh/h	17	9	11	389	450	7
Future Vol, veh/h	17	9	11	389	450	7
Conflicting Peds, #/hr	0	0	0	0	0	0
Sign Control	Stop	Stop	Free	Free	Free	Free
RT Channelized	-	None	-	None	-	None
Storage Length	0	-	-	-	-	-
Veh in Median Storage, #	0	-	-	0	0	-
Grade, %	0	-	-	0	0	-
Peak Hour Factor	87	87	87	87	87	87
Heavy Vehicles, %	0	0	0	0	1	0
Mvmt Flow	20	10	13	447	517	8

Major/Minor	Minor2	Major1	Major2			
Conflicting Flow All	994	521	525	0	-	0
Stage 1	521	-	-	-	-	-
Stage 2	473	-	-	-	-	-
Critical Hdwy	6.4	6.2	4.1	-	-	-
Critical Hdwy Stg 1	5.4	-	-	-	-	-
Critical Hdwy Stg 2	5.4	-	-	-	-	-
Follow-up Hdwy	3.5	3.3	2.2	-	-	-
Pot Cap-1 Maneuver	274	559	1052	-	-	-
Stage 1	600	-	-	-	-	-
Stage 2	631	-	-	-	-	-
Platoon blocked, %				-	-	-
Mov Cap-1 Maneuver	270	559	1052	-	-	-
Mov Cap-2 Maneuver	270	-	-	-	-	-
Stage 1	590	-	-	-	-	-
Stage 2	631	-	-	-	-	-

Approach	WB	SE	NW
HCM Control Delay, s	17	0.2	0
HCM LOS	C		

Minor Lane/Major Mvmt	NWT	NWRWBLn1	SEL	SET
Capacity (veh/h)	-	-	329	1052
HCM Lane V/C Ratio	-	-	0.091	0.012
HCM Control Delay (s)	-	-	17	8.5
HCM Lane LOS	-	-	C	A
HCM 95th %tile Q(veh)	-	-	0.3	0

Intersection						
Int Delay, s/veh	4.1					
Movement	EBL	EBR	NBL	NBT	SBT	SBR
Lane Configurations						
Traffic Vol, veh/h	3	185	134	236	210	3
Future Vol, veh/h	3	185	134	236	210	3
Conflicting Peds, #/hr	0	0	0	0	0	0
Sign Control	Stop	Stop	Free	Free	Free	Free
RT Channelized	-	Yield	-	None	-	None
Storage Length	55	0	100	-	-	-
Veh in Median Storage, #	0	-	-	0	0	-
Grade, %	0	-	-	0	0	-
Peak Hour Factor	88	88	88	88	88	88
Heavy Vehicles, %	0	4	2	3	6	0
Mvmt Flow	3	210	152	268	239	3

Major/Minor	Minor2	Major1		Major2	
Conflicting Flow All	813	241	242	0	0
Stage 1	241	-	-	-	-
Stage 2	572	-	-	-	-
Critical Hdwy	6.4	6.24	4.12	-	-
Critical Hdwy Stg 1	5.4	-	-	-	-
Critical Hdwy Stg 2	5.4	-	-	-	-
Follow-up Hdwy	3.5	3.336	2.218	-	-
Pot Cap-1 Maneuver	351	793	1324	-	-
Stage 1	804	-	-	-	-
Stage 2	569	-	-	-	-
Platoon blocked, %				-	-
Mov Cap-1 Maneuver	311	793	1324	-	-
Mov Cap-2 Maneuver	311	-	-	-	-
Stage 1	712	-	-	-	-
Stage 2	569	-	-	-	-

Approach	EB	NB	SB
HCM Control Delay, s	11.3	2.9	0
HCM LOS	B		

Minor Lane/Major Mvmt	NBL	NBT	EBLn1	EBLn2	SBT	SBR
Capacity (veh/h)	1324	-	311	793	-	-
HCM Lane V/C Ratio	0.115	-	0.011	0.265	-	-
HCM Control Delay (s)	8.1	-	16.7	11.2	-	-
HCM Lane LOS	A	-	C	B	-	-
HCM 95th %tile Q(veh)	0.4	-	0	1.1	-	-

HCM 6th TWSC
7: Sanitarium Rd & Crystal Springs Rd

03-26-2021

Intersection						
Int Delay, s/veh	0.8					
Movement	EBL	EBR	NBL	NBT	SBT	SBR
Lane Configurations						
Traffic Vol, veh/h	8	12	15	144	219	4
Future Vol, veh/h	8	12	15	144	219	4
Conflicting Peds, #/hr	0	0	0	0	0	0
Sign Control	Stop	Stop	Free	Free	Free	Free
RT Channelized	-	None	-	None	-	None
Storage Length	0	-	-	-	-	-
Veh in Median Storage, #	0	-	-	0	0	-
Grade, %	0	-	-	0	0	-
Peak Hour Factor	88	88	88	88	88	88
Heavy Vehicles, %	0	0	0	1	2	0
Mvmt Flow	9	14	17	164	249	5

Major/Minor	Minor2	Major1		Major2	
Conflicting Flow All	450	252	254	0	0
Stage 1	252	-	-	-	-
Stage 2	198	-	-	-	-
Critical Hdwy	6.4	6.2	4.1	-	-
Critical Hdwy Stg 1	5.4	-	-	-	-
Critical Hdwy Stg 2	5.4	-	-	-	-
Follow-up Hdwy	3.5	3.3	2.2	-	-
Pot Cap-1 Maneuver	571	792	1323	-	-
Stage 1	795	-	-	-	-
Stage 2	840	-	-	-	-
Platoon blocked, %				-	-
Mov Cap-1 Maneuver	563	792	1323	-	-
Mov Cap-2 Maneuver	563	-	-	-	-
Stage 1	784	-	-	-	-
Stage 2	840	-	-	-	-

Approach	EB	NB	SB
HCM Control Delay, s	10.5	0.7	0
HCM LOS	B		

Minor Lane/Major Mvmt	NBL	NBT	EBLn1	SBT	SBR
Capacity (veh/h)	1323	-	681	-	-
HCM Lane V/C Ratio	0.013	-	0.033	-	-
HCM Control Delay (s)	7.8	0	10.5	-	-
HCM Lane LOS	A	A	B	-	-
HCM 95th %tile Q(veh)	0	-	0.1	-	-

HCM 6th TWSC
 10: Crystal Springs Rd & Crystal Springs North

03-26-2021

Intersection						
Int Delay, s/veh	4.8					
Movement	EBL	EBT	WBT	WBR	SBL	SBR
Lane Configurations		↶	↷		↶	↷
Traffic Vol, veh/h	7	11	8	1	3	18
Future Vol, veh/h	7	11	8	1	3	18
Conflicting Peds, #/hr	0	0	0	0	0	0
Sign Control	Free	Free	Free	Free	Stop	Stop
RT Channelized	-	None	-	None	-	None
Storage Length	-	-	-	-	0	-
Veh in Median Storage, #	-	0	0	-	0	-
Grade, %	-	0	0	-	0	-
Peak Hour Factor	92	92	92	92	92	92
Heavy Vehicles, %	2	2	2	2	2	2
Mvmt Flow	8	12	9	1	3	20

Major/Minor	Major1	Major2	Minor2		
Conflicting Flow All	10	0	-	0	38
Stage 1	-	-	-	-	10
Stage 2	-	-	-	-	28
Critical Hdwy	4.12	-	-	-	6.42
Critical Hdwy Stg 1	-	-	-	-	5.42
Critical Hdwy Stg 2	-	-	-	-	5.42
Follow-up Hdwy	2.218	-	-	-	3.518
Pot Cap-1 Maneuver	1610	-	-	-	974
Stage 1	-	-	-	-	1013
Stage 2	-	-	-	-	995
Platoon blocked, %		-	-	-	
Mov Cap-1 Maneuver	1610	-	-	-	969
Mov Cap-2 Maneuver	-	-	-	-	969
Stage 1	-	-	-	-	1008
Stage 2	-	-	-	-	995

Approach	EB	WB	SB
HCM Control Delay, s	2.8	0	8.5
HCM LOS			A

Minor Lane/Major Mvmt	EBL	EBT	WBT	WBR	SBLn1
Capacity (veh/h)	1610	-	-	-	1055
HCM Lane V/C Ratio	0.005	-	-	-	0.022
HCM Control Delay (s)	7.2	0	-	-	8.5
HCM Lane LOS	A	A	-	-	A
HCM 95th %tile Q(veh)	0	-	-	-	0.1

HCM 6th AWSC
2: Silverado Trail & Deer Park Rd

03-26-2021

Intersection	
Intersection Delay, s/veh	107
Intersection LOS	F

Movement	EBL	EBT	EBR	WBL	WBT	WBR	NBL	NBT	NBR	SBL	SBT	SBR
Lane Configurations		↖	↗		↖	↗		↖	↗		↖	↗
Traffic Vol, veh/h	21	124	154	142	89	19	203	424	109	20	370	23
Future Vol, veh/h	21	124	154	142	89	19	203	424	109	20	370	23
Peak Hour Factor	0.97	0.97	0.97	0.97	0.97	0.97	0.97	0.97	0.97	0.97	0.97	0.97
Heavy Vehicles, %	0	0	2	0	0	0	0	1	0	0	0	0
Mvmt Flow	22	128	159	146	92	20	209	437	112	21	381	24
Number of Lanes	0	1	1	0	1	1	0	1	1	0	1	1

Approach	EB	WB	NB	SB
Opposing Approach	WB	EB	SB	NB
Opposing Lanes	2	2	2	2
Conflicting Approach Left	SB	NB	EB	WB
Conflicting Lanes Left	2	2	2	2
Conflicting Approach Right	NB	SB	WB	EB
Conflicting Lanes Right	2	2	2	2
HCM Control Delay	17	24.8	203.9	49.4
HCM LOS	C	C	F	E

Lane	NBLn1	NBLn2	EBLn1	EBLn2	WBLn1	WBLn2	SBLn1	SBLn2
Vol Left, %	32%	0%	14%	0%	61%	0%	5%	0%
Vol Thru, %	68%	0%	86%	0%	39%	0%	95%	0%
Vol Right, %	0%	100%	0%	100%	0%	100%	0%	100%
Sign Control	Stop	Stop	Stop	Stop	Stop	Stop	Stop	Stop
Traffic Vol by Lane	627	109	145	154	231	19	390	23
LT Vol	203	0	21	0	142	0	20	0
Through Vol	424	0	124	0	89	0	370	0
RT Vol	0	109	0	154	0	19	0	23
Lane Flow Rate	646	112	149	159	238	20	402	24
Geometry Grp	7	7	7	7	7	7	7	7
Degree of Util (X)	1.451	0.225	0.363	0.352	0.592	0.043	0.895	0.048
Departure Headway (Hd)	8.081	7.208	9.68	8.868	9.881	8.822	8.752	7.995
Convergence, Y/N	Yes	Yes	Yes	Yes	Yes	Yes	Yes	Yes
Cap	452	498	374	408	367	408	418	451
Service Time	5.835	4.961	7.38	6.568	7.581	6.522	6.452	5.695
HCM Lane V/C Ratio	1.429	0.225	0.398	0.39	0.649	0.049	0.962	0.053
HCM Control Delay	237.2	12.1	17.8	16.3	25.9	11.9	51.7	11.1
HCM Lane LOS	F	B	C	C	D	B	F	B
HCM 95th-tile Q	32.4	0.9	1.6	1.6	3.6	0.1	9.4	0.2

HCM 6th TWSC
 1: Silverado Trail & Crystal Springs Rd

03-26-2021

Intersection						
Int Delay, s/veh	0.3					
Movement	WBL	WBR	SEL	SET	NWT	NWR
Lane Configurations	T			T		T
Traffic Vol, veh/h	9	5	7	361	443	2
Future Vol, veh/h	9	5	7	361	443	2
Conflicting Peds, #/hr	0	0	0	0	0	0
Sign Control	Stop	Stop	Free	Free	Free	Free
RT Channelized	-	None	-	None	-	None
Storage Length	0	-	-	-	-	-
Veh in Median Storage, #	0	-	-	0	0	-
Grade, %	0	-	-	0	0	-
Peak Hour Factor	95	95	95	95	95	95
Heavy Vehicles, %	0	0	0	0	1	0
Mvmt Flow	9	5	7	380	466	2

Major/Minor	Minor2	Major1		Major2	
Conflicting Flow All	861	467	468	0	0
Stage 1	467	-	-	-	-
Stage 2	394	-	-	-	-
Critical Hdwy	6.4	6.2	4.1	-	-
Critical Hdwy Stg 1	5.4	-	-	-	-
Critical Hdwy Stg 2	5.4	-	-	-	-
Follow-up Hdwy	3.5	3.3	2.2	-	-
Pot Cap-1 Maneuver	329	600	1104	-	-
Stage 1	635	-	-	-	-
Stage 2	686	-	-	-	-
Platoon blocked, %				-	-
Mov Cap-1 Maneuver	326	600	1104	-	-
Mov Cap-2 Maneuver	326	-	-	-	-
Stage 1	630	-	-	-	-
Stage 2	686	-	-	-	-

Approach	WB	SE	NW
HCM Control Delay, s	14.6	0.2	0
HCM LOS	B		

Minor Lane/Major Mvmt	NWT	NWRWBLn1	SEL	SET
Capacity (veh/h)	-	-	390	1104
HCM Lane V/C Ratio	-	-	0.038	0.007
HCM Control Delay (s)	-	-	14.6	8.3
HCM Lane LOS	-	-	B	A
HCM 95th %tile Q(veh)	-	-	0.1	0

HCM 6th TWSC
6: Deer Park Rd & Sanitarium Rd

03-26-2021

Intersection						
Int Delay, s/veh	3.2					
Movement	EBL	EBR	NBL	NBT	SBT	SBR
Lane Configurations						
Traffic Vol, veh/h	3	93	89	164	157	3
Future Vol, veh/h	3	93	89	164	157	3
Conflicting Peds, #/hr	0	0	0	0	0	0
Sign Control	Stop	Stop	Free	Free	Free	Free
RT Channelized	-	None	-	None	-	None
Storage Length	50	0	50	-	-	-
Veh in Median Storage, #	0	-	-	0	0	-
Grade, %	0	-	-	0	0	-
Peak Hour Factor	92	92	92	92	92	92
Heavy Vehicles, %	0	1	1	3	7	2
Mvmt Flow	3	101	97	178	171	3



Major/Minor	Minor2	Major1		Major2	
Conflicting Flow All	545	173	174	0	0
Stage 1	173	-	-	-	-
Stage 2	372	-	-	-	-
Critical Hdwy	6.4	6.21	4.11	-	-
Critical Hdwy Stg 1	5.4	-	-	-	-
Critical Hdwy Stg 2	5.4	-	-	-	-
Follow-up Hdwy	3.5	3.309	2.209	-	-
Pot Cap-1 Maneuver	503	873	1409	-	-
Stage 1	862	-	-	-	-
Stage 2	702	-	-	-	-
Platoon blocked, %				-	-
Mov Cap-1 Maneuver	468	873	1409	-	-
Mov Cap-2 Maneuver	468	-	-	-	-
Stage 1	803	-	-	-	-
Stage 2	702	-	-	-	-

Approach	EB	NB	SB
HCM Control Delay, s	9.8	2.7	0
HCM LOS	A		

Minor Lane/Major Mvmt	NBL	NBT	EBLn1	EBLn2	SBT	SBR
Capacity (veh/h)	1409	-	468	873	-	-
HCM Lane V/C Ratio	0.069	-	0.007	0.116	-	-
HCM Control Delay (s)	7.7	-	12.7	9.7	-	-
HCM Lane LOS	A	-	B	A	-	-
HCM 95th %tile Q(veh)	0.2	-	0	0.4	-	-

HCM 6th TWSC
7: Sanitarium Rd & Crystal Springs Rd

03-26-2021

Intersection						
Int Delay, s/veh	1.1					
Movement	EBL	EBR	NBL	NBT	SBT	SBR
Lane Configurations						
Traffic Vol, veh/h	8	10	11	91	115	5
Future Vol, veh/h	8	10	11	91	115	5
Conflicting Peds, #/hr	0	0	0	0	0	0
Sign Control	Stop	Stop	Free	Free	Free	Free
RT Channelized	-	None	-	None	-	None
Storage Length	0	-	-	-	-	-
Veh in Median Storage, #	0	-	-	0	0	-
Grade, %	0	-	-	0	0	-
Peak Hour Factor	85	85	85	85	85	85
Heavy Vehicles, %	0	0	0	6	3	0
Mvmt Flow	9	12	13	107	135	6

Major/Minor	Minor2	Major1		Major2	
Conflicting Flow All	271	138	141	0	0
Stage 1	138	-	-	-	-
Stage 2	133	-	-	-	-
Critical Hdwy	6.4	6.2	4.1	-	-
Critical Hdwy Stg 1	5.4	-	-	-	-
Critical Hdwy Stg 2	5.4	-	-	-	-
Follow-up Hdwy	3.5	3.3	2.2	-	-
Pot Cap-1 Maneuver	723	916	1455	-	-
Stage 1	894	-	-	-	-
Stage 2	898	-	-	-	-
Platoon blocked, %				-	-
Mov Cap-1 Maneuver	716	916	1455	-	-
Mov Cap-2 Maneuver	716	-	-	-	-
Stage 1	886	-	-	-	-
Stage 2	898	-	-	-	-

Approach	EB	NB	SB
HCM Control Delay, s	9.5	0.8	0
HCM LOS	A		

Minor Lane/Major Mvmt	NBL	NBT	EBLn1	SBT	SBR
Capacity (veh/h)	1455	-	815	-	-
HCM Lane V/C Ratio	0.009	-	0.026	-	-
HCM Control Delay (s)	7.5	0	9.5	-	-
HCM Lane LOS	A	A	A	-	-
HCM 95th %tile Q(veh)	0	-	0.1	-	-

Intersection

Int Delay, s/veh 3.4

Movement EBL EBT WBT WBR SBL SBR

Lane Configurations		↶	↷		↶	
Traffic Vol, veh/h	5	4	9	0	0	5
Future Vol, veh/h	5	4	9	0	0	5
Conflicting Peds, #/hr	0	0	0	0	0	0
Sign Control	Free	Free	Free	Free	Stop	Stop
RT Channelized	-	None	-	None	-	None
Storage Length	-	-	-	-	0	-
Veh in Median Storage, #	-	0	0	-	0	-
Grade, %	-	0	0	-	0	-
Peak Hour Factor	80	80	80	80	80	80
Heavy Vehicles, %	2	2	2	2	2	2
Mvmt Flow	6	5	11	0	0	6

Major/Minor Major1 Major2 Minor2

Conflicting Flow All	11	0	-	0	28	11
Stage 1	-	-	-	-	11	-
Stage 2	-	-	-	-	17	-
Critical Hdwy	4.12	-	-	-	6.42	6.22
Critical Hdwy Stg 1	-	-	-	-	5.42	-
Critical Hdwy Stg 2	-	-	-	-	5.42	-
Follow-up Hdwy	2.218	-	-	-	3.518	3.318
Pot Cap-1 Maneuver	1608	-	-	-	987	1070
Stage 1	-	-	-	-	1012	-
Stage 2	-	-	-	-	1006	-
Platoon blocked, %		-	-	-		
Mov Cap-1 Maneuver	1608	-	-	-	983	1070
Mov Cap-2 Maneuver	-	-	-	-	983	-
Stage 1	-	-	-	-	1008	-
Stage 2	-	-	-	-	1006	-

Approach EB WB SB

HCM Control Delay, s 4 0 8.4
 HCM LOS A

Minor Lane/Major Mvmt EBL EBT WBT WBR SBLn1

Capacity (veh/h)	1608	-	-	-	1070
HCM Lane V/C Ratio	0.004	-	-	-	0.006
HCM Control Delay (s)	7.2	0	-	-	8.4
HCM Lane LOS	A	A	-	-	A
HCM 95th %tile Q(veh)	0	-	-	-	0

HCM 6th AWSC
2: Silverado Trail & Deer Park Rd

02-11-2021

Intersection	
Intersection Delay, s/veh	77.9
Intersection LOS	F

Movement	EBL	EBT	EBR	WBL	WBT	WBR	NBL	NBT	NBR	SBL	SBT	SBR
Lane Configurations		↖	↗		↖	↗		↖	↗		↖	↗
Traffic Vol, veh/h	25	219	290	227	97	26	115	327	105	6	336	22
Future Vol, veh/h	25	219	290	227	97	26	115	327	105	6	336	22
Peak Hour Factor	0.94	0.94	0.94	0.94	0.94	0.94	0.94	0.94	0.94	0.94	0.94	0.94
Heavy Vehicles, %	0	0	2	0	0	0	0	1	0	0	0	0
Mvmt Flow	27	233	309	241	103	28	122	348	112	6	357	23
Number of Lanes	0	1	1	0	1	1	0	1	1	0	1	1

Approach	EB	WB	NB	SB
Opposing Approach	WB	EB	SB	NB
Opposing Lanes	2	2	2	2
Conflicting Approach Left	SB	NB	EB	WB
Conflicting Lanes Left	2	2	2	2
Conflicting Approach Right	NB	SB	WB	EB
Conflicting Lanes Right	2	2	2	2
HCM Control Delay	33.7	62.7	139	65.3
HCM LOS	D	F	F	F

Lane	NBLn1	NBLn2	EBLn1	EBLn2	WBLn1	WBLn2	SBLn1	SBLn2
Vol Left, %	26%	0%	10%	0%	70%	0%	2%	0%
Vol Thru, %	74%	0%	90%	0%	30%	0%	98%	0%
Vol Right, %	0%	100%	0%	100%	0%	100%	0%	100%
Sign Control	Stop	Stop	Stop	Stop	Stop	Stop	Stop	Stop
Traffic Vol by Lane	442	105	244	290	324	26	342	22
LT Vol	115	0	25	0	227	0	6	0
Through Vol	327	0	219	0	97	0	336	0
RT Vol	0	105	0	290	0	26	0	22
Lane Flow Rate	470	112	260	309	345	28	364	23
Geometry Grp	7	7	7	7	7	7	7	7
Degree of Util (X)	1.268	0.275	0.681	0.745	0.935	0.067	0.952	0.057
Departure Headway (Hd)	9.706	8.851	10.209	9.415	10.525	9.415	10.118	9.37
Convergence, Y/N	Yes	Yes	Yes	Yes	Yes	Yes	Yes	Yes
Cap	376	409	356	386	348	383	360	385
Service Time	7.406	6.551	7.909	7.115	8.225	7.115	7.818	7.07
HCM Lane V/C Ratio	1.25	0.274	0.73	0.801	0.991	0.073	1.011	0.06
HCM Control Delay	168.5	14.9	32.1	35	66.7	12.8	68.7	12.6
HCM Lane LOS	F	B	D	D	F	B	F	B
HCM 95th-tile Q	20.9	1.1	4.8	5.9	9.6	0.2	10.3	0.2

HCM 6th TWSC
 1: Silverado Trail & Crystal Springs Rd

03-26-2021

Intersection						
Int Delay, s/veh	0.6					
Movement	WBL	WBR	SEL	SET	NWT	NWR
Lane Configurations	T			T		T
Traffic Vol, veh/h	17	8	11	352	395	7
Future Vol, veh/h	17	8	11	352	395	7
Conflicting Peds, #/hr	0	0	0	0	0	0
Sign Control	Stop	Stop	Free	Free	Free	Free
RT Channelized	-	None	-	None	-	None
Storage Length	0	-	-	-	-	-
Veh in Median Storage, #	0	-	-	0	0	-
Grade, %	0	-	-	0	0	-
Peak Hour Factor	87	87	87	87	87	87
Heavy Vehicles, %	0	0	0	0	1	0
Mvmt Flow	20	9	13	405	454	8

Major/Minor	Minor2	Major1		Major2	
Conflicting Flow All	889	458	462	0	0
Stage 1	458	-	-	-	-
Stage 2	431	-	-	-	-
Critical Hdwy	6.4	6.2	4.1	-	-
Critical Hdwy Stg 1	5.4	-	-	-	-
Critical Hdwy Stg 2	5.4	-	-	-	-
Follow-up Hdwy	3.5	3.3	2.2	-	-
Pot Cap-1 Maneuver	316	607	1110	-	-
Stage 1	641	-	-	-	-
Stage 2	660	-	-	-	-
Platoon blocked, %				-	-
Mov Cap-1 Maneuver	311	607	1110	-	-
Mov Cap-2 Maneuver	311	-	-	-	-
Stage 1	631	-	-	-	-
Stage 2	660	-	-	-	-

Approach	WB	SE	NW
HCM Control Delay, s	15.6	0.3	0
HCM LOS	C		

Minor Lane/Major Mvmt	NWT	NWRWBLn1	SEL	SET
Capacity (veh/h)	-	-	369	1110
HCM Lane V/C Ratio	-	-	0.078	0.011
HCM Control Delay (s)	-	-	15.6	8.3
HCM Lane LOS	-	-	C	A
HCM 95th %tile Q(veh)	-	-	0.3	0

Intersection						
Int Delay, s/veh	4					
Movement	EBL	EBR	NBL	NBT	SBT	SBR
Lane Configurations	↶	↷	↶	↷	↷	
Traffic Vol, veh/h	1	164	121	210	186	1
Future Vol, veh/h	1	164	121	210	186	1
Conflicting Peds, #/hr	0	0	0	0	0	0
Sign Control	Stop	Stop	Free	Free	Free	Free
RT Channelized	-	Yield	-	None	-	None
Storage Length	55	0	100	-	-	-
Veh in Median Storage, #	0	-	-	0	0	-
Grade, %	0	-	-	0	0	-
Peak Hour Factor	88	88	88	88	88	88
Heavy Vehicles, %	0	4	2	3	6	0
Mvmt Flow	1	186	138	239	211	1

Major/Minor	Minor2	Major1		Major2	
Conflicting Flow All	727	212	212	0	0
Stage 1	212	-	-	-	-
Stage 2	515	-	-	-	-
Critical Hdwy	6.4	6.24	4.12	-	-
Critical Hdwy Stg 1	5.4	-	-	-	-
Critical Hdwy Stg 2	5.4	-	-	-	-
Follow-up Hdwy	3.5	3.336	2.218	-	-
Pot Cap-1 Maneuver	394	823	1358	-	-
Stage 1	828	-	-	-	-
Stage 2	604	-	-	-	-
Platoon blocked, %				-	-
Mov Cap-1 Maneuver	354	823	1358	-	-
Mov Cap-2 Maneuver	354	-	-	-	-
Stage 1	744	-	-	-	-
Stage 2	604	-	-	-	-

Approach	EB	NB	SB
HCM Control Delay, s	10.7	2.9	0
HCM LOS	B		

Minor Lane/Major Mvmt	NBL	NBT	EBLn1	EBLn2	SBT	SBR
Capacity (veh/h)	1358	-	354	823	-	-
HCM Lane V/C Ratio	0.101	-	0.003	0.226	-	-
HCM Control Delay (s)	7.9	-	15.2	10.7	-	-
HCM Lane LOS	A	-	C	B	-	-
HCM 95th %tile Q(veh)	0.3	-	0	0.9	-	-

HCM 6th TWSC
7: Sanitarium Rd & Crystal Springs Rd

03-26-2021

Intersection						
Int Delay, s/veh	0.8					
Movement	NBL	NBT	SBT	SBR	SEL	SER
Lane Configurations		↶	↷		↶	↷
Traffic Vol, veh/h	14	127	192	3	6	11
Future Vol, veh/h	14	127	192	3	6	11
Conflicting Peds, #/hr	0	0	0	0	0	0
Sign Control	Free	Free	Free	Free	Stop	Stop
RT Channelized	-	None	-	None	-	None
Storage Length	-	-	-	-	0	-
Veh in Median Storage, #	-	0	0	-	0	-
Grade, %	-	0	0	-	0	-
Peak Hour Factor	88	88	88	88	88	88
Heavy Vehicles, %	0	1	2	0	0	0
Mvmt Flow	16	144	218	3	7	13

Major/Minor	Major1	Major2	Minor2		
Conflicting Flow All	221	0	0	396	220
Stage 1	-	-	-	220	-
Stage 2	-	-	-	176	-
Critical Hdwy	4.1	-	-	6.4	6.2
Critical Hdwy Stg 1	-	-	-	5.4	-
Critical Hdwy Stg 2	-	-	-	5.4	-
Follow-up Hdwy	2.2	-	-	3.5	3.3
Pot Cap-1 Maneuver	1360	-	-	613	825
Stage 1	-	-	-	821	-
Stage 2	-	-	-	859	-
Platoon blocked, %		-	-		
Mov Cap-1 Maneuver	1360	-	-	605	825
Mov Cap-2 Maneuver	-	-	-	605	-
Stage 1	-	-	-	810	-
Stage 2	-	-	-	859	-

Approach	NB	SB	SE
HCM Control Delay, s	0.8	0	10.1
HCM LOS			B

Minor Lane/Major Mvmt	NBL	NBT	SELn1	SBT	SBR
Capacity (veh/h)	1360	-	731	-	-
HCM Lane V/C Ratio	0.012	-	0.026	-	-
HCM Control Delay (s)	7.7	0	10.1	-	-
HCM Lane LOS	A	A	B	-	-
HCM 95th %tile Q(veh)	0	-	0.1	-	-

HCM 6th TWSC
 9: Project Dwy & Crystal Springs Rd/Crystal Springs

03-26-2021

Intersection						
Int Delay, s/veh	2					
Movement	SET	SER	NWL	NWT	NEL	NER
Lane Configurations						
Traffic Vol, veh/h	8	4	1	7	4	1
Future Vol, veh/h	8	4	1	7	4	1
Conflicting Peds, #/hr	0	0	0	0	0	0
Sign Control	Free	Free	Free	Free	Stop	Stop
RT Channelized	-	None	-	None	-	None
Storage Length	-	-	-	-	0	-
Veh in Median Storage, #	0	-	-	0	0	-
Grade, %	0	-	-	0	0	-
Peak Hour Factor	70	70	70	70	70	70
Heavy Vehicles, %	0	0	0	0	0	0
Mvmt Flow	11	6	1	10	6	1

Major/Minor	Major1	Major2	Minor1	Minor2	Minor3
Conflicting Flow All	0	0	17	0	26
Stage 1	-	-	-	-	14
Stage 2	-	-	-	-	12
Critical Hdwy	-	-	4.1	-	6.4
Critical Hdwy Stg 1	-	-	-	-	5.4
Critical Hdwy Stg 2	-	-	-	-	5.4
Follow-up Hdwy	-	-	2.2	-	3.5
Pot Cap-1 Maneuver	-	-	1613	-	995
Stage 1	-	-	-	-	1014
Stage 2	-	-	-	-	1016
Platoon blocked, %	-	-	-	-	-
Mov Cap-1 Maneuver	-	-	1613	-	994
Mov Cap-2 Maneuver	-	-	-	-	994
Stage 1	-	-	-	-	1014
Stage 2	-	-	-	-	1015

Approach	SE	NW	NE
HCM Control Delay, s	0	0.9	8.6
HCM LOS			A

Minor Lane/Major Mvmt	NELn1	NWL	NWT	SET	SER
Capacity (veh/h)	1009	1613	-	-	-
HCM Lane V/C Ratio	0.007	0.001	-	-	-
HCM Control Delay (s)	8.6	7.2	0	-	-
HCM Lane LOS	A	A	A	-	-
HCM 95th %tile Q(veh)	0	0	-	-	-

Intersection

Int Delay, s/veh 4.2

Movement	EBL	EBT	WBT	WBR	SBL	SBR
Lane Configurations		↕	↕		↕	
Traffic Vol, veh/h	6	12	10	1	3	15
Future Vol, veh/h	6	12	10	1	3	15
Conflicting Peds, #/hr	0	0	0	0	0	0
Sign Control	Free	Free	Free	Free	Stop	Stop
RT Channelized	-	None	-	None	-	None
Storage Length	-	-	-	-	0	-
Veh in Median Storage, #	-	0	0	-	0	-
Grade, %	-	0	0	-	0	-
Peak Hour Factor	80	80	80	80	80	80
Heavy Vehicles, %	0	0	0	0	0	0
Mvmt Flow	8	15	13	1	4	19

Major/Minor	Major1	Major2	Minor2		
Conflicting Flow All	14	0	-	0	45
Stage 1	-	-	-	-	14
Stage 2	-	-	-	-	31
Critical Hdwy	4.1	-	-	-	6.4
Critical Hdwy Stg 1	-	-	-	-	5.4
Critical Hdwy Stg 2	-	-	-	-	5.4
Follow-up Hdwy	2.2	-	-	-	3.5
Pot Cap-1 Maneuver	1617	-	-	-	970
Stage 1	-	-	-	-	1014
Stage 2	-	-	-	-	997
Platoon blocked, %		-	-	-	
Mov Cap-1 Maneuver	1617	-	-	-	965
Mov Cap-2 Maneuver	-	-	-	-	965
Stage 1	-	-	-	-	1009
Stage 2	-	-	-	-	997

Approach	EB	WB	SB
HCM Control Delay, s	2.4	0	8.5
HCM LOS			A

Minor Lane/Major Mvmt	EBL	EBT	WBT	WBR	SBLn1
Capacity (veh/h)	1617	-	-	-	1053
HCM Lane V/C Ratio	0.005	-	-	-	0.021
HCM Control Delay (s)	7.2	0	-	-	8.5
HCM Lane LOS	A	A	-	-	A
HCM 95th %tile Q(veh)	0	-	-	-	0.1

HCM 6th TWSC
 1: Silverado Trail & Crystal Springs Rd

02-11-2021

Intersection						
Int Delay, s/veh	0.4					
Movement	WBL	WBR	SEL	SET	NWT	NWR
Lane Configurations	T			T		
Traffic Vol, veh/h	10	5	7	288	365	1
Future Vol, veh/h	10	5	7	288	365	1
Conflicting Peds, #/hr	0	0	0	0	0	0
Sign Control	Stop	Stop	Free	Free	Free	Free
RT Channelized	-	None	-	None	-	None
Storage Length	0	-	-	-	-	-
Veh in Median Storage, #	0	-	-	0	0	-
Grade, %	0	-	-	0	0	-
Peak Hour Factor	95	95	95	95	95	95
Heavy Vehicles, %	0	0	0	0	1	0
Mvmt Flow	11	5	7	303	384	1

Major/Minor	Minor2	Major1		Major2	
Conflicting Flow All	702	385	385	0	0
Stage 1	385	-	-	-	-
Stage 2	317	-	-	-	-
Critical Hdwy	6.4	6.2	4.1	-	-
Critical Hdwy Stg 1	5.4	-	-	-	-
Critical Hdwy Stg 2	5.4	-	-	-	-
Follow-up Hdwy	3.5	3.3	2.2	-	-
Pot Cap-1 Maneuver	407	667	1185	-	-
Stage 1	692	-	-	-	-
Stage 2	743	-	-	-	-
Platoon blocked, %				-	-
Mov Cap-1 Maneuver	404	667	1185	-	-
Mov Cap-2 Maneuver	404	-	-	-	-
Stage 1	687	-	-	-	-
Stage 2	743	-	-	-	-

Approach	WB	SE	NW
HCM Control Delay, s	13	0.2	0
HCM LOS	B		

Minor Lane/Major Mvmt	NWT	NWRWBLn1	SEL	SET
Capacity (veh/h)	-	-	465	1185
HCM Lane V/C Ratio	-	-	0.034	0.006
HCM Control Delay (s)	-	-	13	8.1
HCM Lane LOS	-	-	B	A
HCM 95th %tile Q(veh)	-	-	0.1	0

Intersection						
Int Delay, s/veh	3.2					
Movement	EBL	EBR	NBL	NBT	SBT	SBR
Lane Configurations						
Traffic Vol, veh/h	1	84	80	143	141	1
Future Vol, veh/h	1	84	80	143	141	1
Conflicting Peds, #/hr	0	0	0	0	0	0
Sign Control	Stop	Stop	Free	Free	Free	Free
RT Channelized	-	None	-	None	-	None
Storage Length	50	0	50	-	-	-
Veh in Median Storage, #	0	-	-	0	0	-
Grade, %	0	-	-	0	0	-
Peak Hour Factor	92	92	92	92	92	92
Heavy Vehicles, %	0	1	1	3	7	2
Mvmt Flow	1	91	87	155	153	1

Major/Minor	Minor2	Major1		Major2	
Conflicting Flow All	483	154	154	0	0
Stage 1	154	-	-	-	-
Stage 2	329	-	-	-	-
Critical Hdwy	6.4	6.21	4.11	-	-
Critical Hdwy Stg 1	5.4	-	-	-	-
Critical Hdwy Stg 2	5.4	-	-	-	-
Follow-up Hdwy	3.5	3.309	2.209	-	-
Pot Cap-1 Maneuver	546	895	1433	-	-
Stage 1	879	-	-	-	-
Stage 2	734	-	-	-	-
Platoon blocked, %				-	-
Mov Cap-1 Maneuver	513	895	1433	-	-
Mov Cap-2 Maneuver	513	-	-	-	-
Stage 1	825	-	-	-	-
Stage 2	734	-	-	-	-

Approach	EB	NB	SB
HCM Control Delay, s	9.5	2.8	0
HCM LOS	A		

Minor Lane/Major Mvmt	NBL	NBT	EBLn1	EBLn2	SBT	SBR
Capacity (veh/h)	1433	-	513	895	-	-
HCM Lane V/C Ratio	0.061	-	0.002	0.102	-	-
HCM Control Delay (s)	7.7	-	12	9.5	-	-
HCM Lane LOS	A	-	B	A	-	-
HCM 95th %tile Q(veh)	0.2	-	0	0.3	-	-

HCM 6th TWSC
7: Sanitarium Rd & Crystal Springs Rd

02-11-2021

Intersection						
Int Delay, s/veh	1					
Movement	NBL	NBT	SBT	SBR	SEL	SER
Lane Configurations		↶	↷		↶	↷
Traffic Vol, veh/h	10	79	103	3	6	9
Future Vol, veh/h	10	79	103	3	6	9
Conflicting Peds, #/hr	0	0	0	0	0	0
Sign Control	Free	Free	Free	Free	Stop	Stop
RT Channelized	-	None	-	None	-	None
Storage Length	-	-	-	-	0	-
Veh in Median Storage, #	-	0	0	-	0	-
Grade, %	-	0	0	-	0	-
Peak Hour Factor	85	85	85	85	85	85
Heavy Vehicles, %	0	6	3	0	0	0
Mvmt Flow	12	93	121	4	7	11

Major/Minor	Major1	Major2	Minor2		
Conflicting Flow All	125	0	-	0	240
Stage 1	-	-	-	-	123
Stage 2	-	-	-	-	117
Critical Hdwy	4.1	-	-	-	6.4
Critical Hdwy Stg 1	-	-	-	-	5.4
Critical Hdwy Stg 2	-	-	-	-	5.4
Follow-up Hdwy	2.2	-	-	-	3.5
Pot Cap-1 Maneuver	1474	-	-	-	753
Stage 1	-	-	-	-	907
Stage 2	-	-	-	-	913
Platoon blocked, %		-	-	-	
Mov Cap-1 Maneuver	1474	-	-	-	746
Mov Cap-2 Maneuver	-	-	-	-	746
Stage 1	-	-	-	-	899
Stage 2	-	-	-	-	913

Approach	NB	SB	SE
HCM Control Delay, s	0.8	0	9.3
HCM LOS			A

Minor Lane/Major Mvmt	NBL	NBT	SELn1	SBT	SBR
Capacity (veh/h)	1474	-	848	-	-
HCM Lane V/C Ratio	0.008	-	0.021	-	-
HCM Control Delay (s)	7.5	0	9.3	-	-
HCM Lane LOS	A	A	A	-	-
HCM 95th %tile Q(veh)	0	-	0.1	-	-

HCM 6th TWSC
 9: Project Dwy & Crystal Springs Rd/Crystal Springs

02-11-2021

Intersection						
Int Delay, s/veh	2.4					
Movement	SET	SER	NWL	NWT	NEL	NER
Lane Configurations						
Traffic Vol, veh/h	3	2	1	7	3	1
Future Vol, veh/h	3	2	1	7	3	1
Conflicting Peds, #/hr	0	0	0	0	0	0
Sign Control	Free	Free	Free	Free	Stop	Stop
RT Channelized	-	None	-	None	-	None
Storage Length	-	-	-	-	0	-
Veh in Median Storage, #	0	-	-	0	0	-
Grade, %	0	-	-	0	0	-
Peak Hour Factor	70	70	70	70	70	70
Heavy Vehicles, %	0	0	0	0	0	0
Mvmt Flow	4	3	1	10	4	1

Major/Minor	Major1	Major2	Minor1	Minor2	Minor3
Conflicting Flow All	0	0	7	0	18
Stage 1	-	-	-	-	6
Stage 2	-	-	-	-	12
Critical Hdwy	-	-	4.1	-	6.4
Critical Hdwy Stg 1	-	-	-	-	5.4
Critical Hdwy Stg 2	-	-	-	-	5.4
Follow-up Hdwy	-	-	2.2	-	3.5
Pot Cap-1 Maneuver	-	-	1627	-	1005
Stage 1	-	-	-	-	1022
Stage 2	-	-	-	-	1016
Platoon blocked, %	-	-	-	-	-
Mov Cap-1 Maneuver	-	-	1627	-	1004
Mov Cap-2 Maneuver	-	-	-	-	1004
Stage 1	-	-	-	-	1022
Stage 2	-	-	-	-	1015

Approach	SE	NW	NE
HCM Control Delay, s	0	0.9	8.5
HCM LOS			A

Minor Lane/Major Mvmt	NELn1	NWL	NWT	SET	SER
Capacity (veh/h)	1023	1627	-	-	-
HCM Lane V/C Ratio	0.006	0.001	-	-	-
HCM Control Delay (s)	8.5	7.2	0	-	-
HCM Lane LOS	A	A	A	-	-
HCM 95th %tile Q(veh)	0	0	-	-	-

Intersection

Int Delay, s/veh 2.4

Movement	EBL	EBT	WBT	WBR	SBL	SBR
Lane Configurations		↕	↕		↕	
Traffic Vol, veh/h	3	5	11	0	0	4
Future Vol, veh/h	3	5	11	0	0	4
Conflicting Peds, #/hr	0	0	0	0	0	0
Sign Control	Free	Free	Free	Free	Stop	Stop
RT Channelized	-	None	-	None	-	None
Storage Length	-	-	-	-	0	-
Veh in Median Storage, #	-	0	0	-	0	-
Grade, %	-	0	0	-	0	-
Peak Hour Factor	80	80	80	80	80	80
Heavy Vehicles, %	2	2	2	2	2	2
Mvmt Flow	4	6	14	0	0	5

Major/Minor

	Major1	Major2	Minor2		
Conflicting Flow All	14	0	-	0	28
Stage 1	-	-	-	-	14
Stage 2	-	-	-	-	14
Critical Hdwy	4.12	-	-	-	6.42
Critical Hdwy Stg 1	-	-	-	-	5.42
Critical Hdwy Stg 2	-	-	-	-	5.42
Follow-up Hdwy	2.218	-	-	-	3.518
Pot Cap-1 Maneuver	1604	-	-	-	987
Stage 1	-	-	-	-	1009
Stage 2	-	-	-	-	1009
Platoon blocked, %		-	-	-	
Mov Cap-1 Maneuver	1604	-	-	-	984
Mov Cap-2 Maneuver	-	-	-	-	984
Stage 1	-	-	-	-	1006
Stage 2	-	-	-	-	1009

Approach

	EB	WB	SB
HCM Control Delay, s	2.7	0	8.4
HCM LOS			A

Minor Lane/Major Mvmt

	EBL	EBT	WBT	WBR	SBLn1
Capacity (veh/h)	1604	-	-	-	1066
HCM Lane V/C Ratio	0.002	-	-	-	0.005
HCM Control Delay (s)	7.2	0	-	-	8.4
HCM Lane LOS	A	A	-	-	A
HCM 95th %tile Q(veh)	0	-	-	-	0

HCM 6th AWSC
2: Silverado Trail & Deer Park Rd

02-11-2021

Intersection	
Intersection Delay, s/veh	46.7
Intersection LOS	E

Movement	EBL	EBT	EBR	WBL	WBT	WBR	NBL	NBT	NBR	SBL	SBT	SBR
Lane Configurations		↖	↗		↖	↗		↖	↗		↖	↗
Traffic Vol, veh/h	17	109	132	131	78	16	174	340	98	16	293	20
Future Vol, veh/h	17	109	132	131	78	16	174	340	98	16	293	20
Peak Hour Factor	0.97	0.97	0.97	0.97	0.97	0.97	0.97	0.97	0.97	0.97	0.97	0.97
Heavy Vehicles, %	0	0	2	0	0	0	0	1	0	0	0	0
Mvmt Flow	18	112	136	135	80	16	179	351	101	16	302	21
Number of Lanes	0	1	1	0	1	1	0	1	1	0	1	1

Approach	EB	WB	NB	SB
Opposing Approach	WB	EB	SB	NB
Opposing Lanes	2	2	2	2
Conflicting Approach Left	SB	NB	EB	WB
Conflicting Lanes Left	2	2	2	2
Conflicting Approach Right	NB	SB	WB	EB
Conflicting Lanes Right	2	2	2	2
HCM Control Delay	14.2	19.6	82.4	24.5
HCM LOS	B	C	F	C

Lane	NBLn1	NBLn2	EBLn1	EBLn2	WBLn1	WBLn2	SBLn1	SBLn2
Vol Left, %	34%	0%	13%	0%	63%	0%	5%	0%
Vol Thru, %	66%	0%	87%	0%	37%	0%	95%	0%
Vol Right, %	0%	100%	0%	100%	0%	100%	0%	100%
Sign Control	Stop	Stop	Stop	Stop	Stop	Stop	Stop	Stop
Traffic Vol by Lane	514	98	126	132	209	16	309	20
LT Vol	174	0	17	0	131	0	16	0
Through Vol	340	0	109	0	78	0	293	0
RT Vol	0	98	0	132	0	16	0	20
Lane Flow Rate	530	101	130	136	215	16	319	21
Geometry Grp	7	7	7	7	7	7	7	7
Degree of Util (X)	1.096	0.184	0.299	0.283	0.509	0.034	0.673	0.039
Departure Headway (Hd)	7.443	6.569	8.605	7.808	8.816	7.764	7.891	7.141
Convergence, Y/N	Yes	Yes	Yes	Yes	Yes	Yes	Yes	Yes
Cap	493	550	421	463	412	464	462	505
Service Time	5.143	4.269	6.305	5.508	6.516	5.464	5.591	4.841
HCM Lane V/C Ratio	1.075	0.184	0.309	0.294	0.522	0.034	0.69	0.042
HCM Control Delay	96.1	10.7	14.9	13.6	20.3	10.7	25.4	10.1
HCM Lane LOS	F	B	B	B	C	B	D	B
HCM 95th-tile Q	17.3	0.7	1.2	1.2	2.8	0.1	4.9	0.1

HCM 6th AWSC
2: Silverado Trail & Deer Park Rd

03-26-2021

Intersection	
Intersection Delay, s/veh	110.8
Intersection LOS	F

Movement	EBL	EBT	EBR	WBL	WBT	WBR	NBL	NBT	NBR	SBL	SBT	SBR
Lane Configurations		↖	↗		↖	↗		↖	↗		↖	↗
Traffic Vol, veh/h	26	232	317	241	105	28	125	372	110	8	376	25
Future Vol, veh/h	26	232	317	241	105	28	125	372	110	8	376	25
Peak Hour Factor	0.94	0.94	0.94	0.94	0.94	0.94	0.94	0.94	0.94	0.94	0.94	0.94
Heavy Vehicles, %	0	0	2	0	0	0	0	1	0	0	0	0
Mvmt Flow	28	247	337	256	112	30	133	396	117	9	400	27
Number of Lanes	0	1	1	0	1	1	0	1	1	0	1	1

Approach	EB	WB	NB	SB
Opposing Approach	WB	EB	SB	NB
Opposing Lanes	2	2	2	2
Conflicting Approach Left	SB	NB	EB	WB
Conflicting Lanes Left	2	2	2	2
Conflicting Approach Right	NB	SB	WB	EB
Conflicting Lanes Right	2	2	2	2
HCM Control Delay	43.5	82.9	195.7	105.1
HCM LOS	E	F	F	F

Lane	NBLn1	NBLn2	EBLn1	EBLn2	WBLn1	WBLn2	SBLn1	SBLn2
Vol Left, %	25%	0%	10%	0%	70%	0%	2%	0%
Vol Thru, %	75%	0%	90%	0%	30%	0%	98%	0%
Vol Right, %	0%	100%	0%	100%	0%	100%	0%	100%
Sign Control	Stop	Stop	Stop	Stop	Stop	Stop	Stop	Stop
Traffic Vol by Lane	497	110	258	317	346	28	384	25
LT Vol	125	0	26	0	241	0	8	0
Through Vol	372	0	232	0	105	0	376	0
RT Vol	0	110	0	317	0	28	0	25
Lane Flow Rate	529	117	274	337	368	30	409	27
Geometry Grp	7	7	7	7	7	7	7	7
Degree of Util (X)	1.429	0.29	0.735	0.834	1.015	0.073	1.098	0.066
Departure Headway (Hd)	10.226	9.371	10.9	10.101	11.113	9.998	10.621	9.866
Convergence, Y/N	Yes	Yes	Yes	Yes	Yes	Yes	Yes	Yes
Cap	360	386	335	361	331	360	343	365
Service Time	7.926	7.071	8.6	7.801	8.813	7.698	8.321	7.566
HCM Lane V/C Ratio	1.469	0.303	0.818	0.934	1.112	0.083	1.192	0.074
HCM Control Delay	235.5	15.9	38.6	47.5	88.5	13.5	111.1	13.3
HCM Lane LOS	F	C	E	E	F	B	F	B
HCM 95th-tile Q	26.1	1.2	5.5	7.5	11.4	0.2	14.1	0.2

HCM 6th TWSC
 1: Silverado Trail & Crystal Springs Rd

03-26-2021

Intersection						
Int Delay, s/veh	0.6					
Movement	WBL	WBR	SEL	SET	NWT	NWR
Lane Configurations	T			T		T
Traffic Vol, veh/h	18	9	11	355	405	8
Future Vol, veh/h	18	9	11	355	405	8
Conflicting Peds, #/hr	0	0	0	0	0	0
Sign Control	Stop	Stop	Free	Free	Free	Free
RT Channelized	-	None	-	None	-	None
Storage Length	0	-	-	-	-	-
Veh in Median Storage, #	0	-	-	0	0	-
Grade, %	0	-	-	0	0	-
Peak Hour Factor	87	87	87	87	87	87
Heavy Vehicles, %	0	0	0	0	1	0
Mvmt Flow	21	10	13	408	466	9

Major/Minor	Minor2	Major1	Major2			
Conflicting Flow All	905	471	475	0	-	0
Stage 1	471	-	-	-	-	-
Stage 2	434	-	-	-	-	-
Critical Hdwy	6.4	6.2	4.1	-	-	-
Critical Hdwy Stg 1	5.4	-	-	-	-	-
Critical Hdwy Stg 2	5.4	-	-	-	-	-
Follow-up Hdwy	3.5	3.3	2.2	-	-	-
Pot Cap-1 Maneuver	309	597	1098	-	-	-
Stage 1	632	-	-	-	-	-
Stage 2	658	-	-	-	-	-
Platoon blocked, %				-	-	-
Mov Cap-1 Maneuver	304	597	1098	-	-	-
Mov Cap-2 Maneuver	304	-	-	-	-	-
Stage 1	623	-	-	-	-	-
Stage 2	658	-	-	-	-	-

Approach	WB	SE	NW
HCM Control Delay, s	15.8	0.2	0
HCM LOS	C		

Minor Lane/Major Mvmt	NWT	NWRWBLn1	SEL	SET
Capacity (veh/h)	-	-	363	1098
HCM Lane V/C Ratio	-	-	0.085	0.012
HCM Control Delay (s)	-	-	15.8	8.3
HCM Lane LOS	-	-	C	A
HCM 95th %tile Q(veh)	-	-	0.3	0

Intersection						
Int Delay, s/veh	4.1					
Movement	EBL	EBR	NBL	NBT	SBT	SBR
Lane Configurations						
Traffic Vol, veh/h	2	176	128	222	198	2
Future Vol, veh/h	2	176	128	222	198	2
Conflicting Peds, #/hr	0	0	0	0	0	0
Sign Control	Stop	Stop	Free	Free	Free	Free
RT Channelized	-	Yield	-	None	-	None
Storage Length	55	0	100	-	-	-
Veh in Median Storage, #	0	-	-	0	0	-
Grade, %	0	-	-	0	0	-
Peak Hour Factor	88	88	88	88	88	88
Heavy Vehicles, %	0	4	2	3	6	0
Mvmt Flow	2	200	145	252	225	2

Major/Minor	Minor2	Major1		Major2	
Conflicting Flow All	768	226	227	0	0
Stage 1	226	-	-	-	-
Stage 2	542	-	-	-	-
Critical Hdwy	6.4	6.24	4.12	-	-
Critical Hdwy Stg 1	5.4	-	-	-	-
Critical Hdwy Stg 2	5.4	-	-	-	-
Follow-up Hdwy	3.5	3.336	2.218	-	-
Pot Cap-1 Maneuver	373	808	1341	-	-
Stage 1	816	-	-	-	-
Stage 2	587	-	-	-	-
Platoon blocked, %				-	-
Mov Cap-1 Maneuver	333	808	1341	-	-
Mov Cap-2 Maneuver	333	-	-	-	-
Stage 1	728	-	-	-	-
Stage 2	587	-	-	-	-

Approach	EB	NB	SB
HCM Control Delay, s	11	2.9	0
HCM LOS	B		

Minor Lane/Major Mvmt	NBL	NBT	EBLn1	EBLn2	SBT	SBR
Capacity (veh/h)	1341	-	333	808	-	-
HCM Lane V/C Ratio	0.108	-	0.007	0.248	-	-
HCM Control Delay (s)	8	-	15.9	10.9	-	-
HCM Lane LOS	A	-	C	B	-	-
HCM 95th %tile Q(veh)	0.4	-	0	1	-	-

HCM 6th TWSC
7: Sanitarium Rd & Crystal Springs Rd

03-26-2021

Intersection						
Int Delay, s/veh	0.8					
Movement	NBL	NBT	SBT	SBR	SEL	SER
Lane Configurations		↕	↕		↕	
Traffic Vol, veh/h	15	136	206	4	7	12
Future Vol, veh/h	15	136	206	4	7	12
Conflicting Peds, #/hr	0	0	0	0	0	0
Sign Control	Free	Free	Free	Free	Stop	Stop
RT Channelized	-	None	-	None	-	None
Storage Length	-	-	-	-	0	-
Veh in Median Storage, #	-	0	0	-	0	-
Grade, %	-	0	0	-	0	-
Peak Hour Factor	88	88	88	88	88	88
Heavy Vehicles, %	0	1	2	0	0	0
Mvmt Flow	17	155	234	5	8	14

Major/Minor	Major1	Major2	Minor2		
Conflicting Flow All	239	0	0	426	237
Stage 1	-	-	-	237	-
Stage 2	-	-	-	189	-
Critical Hdwy	4.1	-	-	6.4	6.2
Critical Hdwy Stg 1	-	-	-	5.4	-
Critical Hdwy Stg 2	-	-	-	5.4	-
Follow-up Hdwy	2.2	-	-	3.5	3.3
Pot Cap-1 Maneuver	1340	-	-	589	807
Stage 1	-	-	-	807	-
Stage 2	-	-	-	848	-
Platoon blocked, %		-	-		
Mov Cap-1 Maneuver	1340	-	-	581	807
Mov Cap-2 Maneuver	-	-	-	581	-
Stage 1	-	-	-	796	-
Stage 2	-	-	-	848	-

Approach	NB	SB	SE
HCM Control Delay, s	0.8	0	10.3
HCM LOS			B

Minor Lane/Major Mvmt	NBL	NBT	SELn1	SBT	SBR
Capacity (veh/h)	1340	-	706	-	-
HCM Lane V/C Ratio	0.013	-	0.031	-	-
HCM Control Delay (s)	7.7	0	10.3	-	-
HCM Lane LOS	A	A	B	-	-
HCM 95th %tile Q(veh)	0	-	0.1	-	-

HCM 6th TWSC
 9: Project Dwy & Crystal Springs Rd/Crystal Springs

03-26-2021

Intersection						
Int Delay, s/veh	1.9					
Movement	SET	SER	NWL	NWT	NEL	NER
Lane Configurations						
Traffic Vol, veh/h	9	4	1	8	4	1
Future Vol, veh/h	9	4	1	8	4	1
Conflicting Peds, #/hr	0	0	0	0	0	0
Sign Control	Free	Free	Free	Free	Stop	Stop
RT Channelized	-	None	-	None	-	None
Storage Length	-	-	-	-	0	-
Veh in Median Storage, #	0	-	-	0	0	-
Grade, %	0	-	-	0	0	-
Peak Hour Factor	70	70	70	70	70	70
Heavy Vehicles, %	0	0	0	0	0	0
Mvmt Flow	13	6	1	11	6	1

Major/Minor	Major1	Major2	Minor1	Minor2	Minor3
Conflicting Flow All	0	0	19	0	29
Stage 1	-	-	-	-	16
Stage 2	-	-	-	-	13
Critical Hdwy	-	-	4.1	-	6.4
Critical Hdwy Stg 1	-	-	-	-	5.4
Critical Hdwy Stg 2	-	-	-	-	5.4
Follow-up Hdwy	-	-	2.2	-	3.5
Pot Cap-1 Maneuver	-	-	1611	-	991
Stage 1	-	-	-	-	1012
Stage 2	-	-	-	-	1015
Platoon blocked, %	-	-	-	-	-
Mov Cap-1 Maneuver	-	-	1611	-	990
Mov Cap-2 Maneuver	-	-	-	-	990
Stage 1	-	-	-	-	1012
Stage 2	-	-	-	-	1014

Approach	SE	NW	NE
HCM Control Delay, s	0	0.8	8.6
HCM LOS			A

Minor Lane/Major Mvmt	NELn1	NWL	NWT	SET	SER
Capacity (veh/h)	1005	1611	-	-	-
HCM Lane V/C Ratio	0.007	0.001	-	-	-
HCM Control Delay (s)	8.6	7.2	0	-	-
HCM Lane LOS	A	A	A	-	-
HCM 95th %tile Q(veh)	0	0	-	-	-

Intersection

Int Delay, s/veh 4.1

Movement	EBL	EBT	WBT	WBR	SBL	SBR
Lane Configurations		↕	↕		↕	
Traffic Vol, veh/h	6	13	11	1	3	16
Future Vol, veh/h	6	13	11	1	3	16
Conflicting Peds, #/hr	0	0	0	0	0	0
Sign Control	Free	Free	Free	Free	Stop	Stop
RT Channelized	-	None	-	None	-	None
Storage Length	-	-	-	-	0	-
Veh in Median Storage, #	-	0	0	-	0	-
Grade, %	-	0	0	-	0	-
Peak Hour Factor	80	80	80	80	80	80
Heavy Vehicles, %	0	0	0	0	0	0
Mvmt Flow	8	16	14	1	4	20

Major/Minor	Major1	Major2	Minor2
Conflicting Flow All	15	0	0 47 15
Stage 1	-	-	- 15 -
Stage 2	-	-	- 32 -
Critical Hdwy	4.1	-	- 6.4 6.2
Critical Hdwy Stg 1	-	-	- 5.4 -
Critical Hdwy Stg 2	-	-	- 5.4 -
Follow-up Hdwy	2.2	-	- 3.5 3.3
Pot Cap-1 Maneuver	1616	-	- 968 1070
Stage 1	-	-	- 1013 -
Stage 2	-	-	- 996 -
Platoon blocked, %		-	- -
Mov Cap-1 Maneuver	1616	-	- 963 1070
Mov Cap-2 Maneuver	-	-	- 963 -
Stage 1	-	-	- 1008 -
Stage 2	-	-	- 996 -

Approach	EB	WB	SB
HCM Control Delay, s	2.3	0	8.5
HCM LOS			A

Minor Lane/Major Mvmt	EBL	EBT	WBT	WBR	SBLn1
Capacity (veh/h)	1616	-	-	-	1052
HCM Lane V/C Ratio	0.005	-	-	-	0.023
HCM Control Delay (s)	7.2	0	-	-	8.5
HCM Lane LOS	A	A	-	-	A
HCM 95th %tile Q(veh)	0	-	-	-	0.1

HCM 6th AWSC
2: Silverado Trail & Deer Park Rd

03-26-2021

Intersection	
Intersection Delay, s/veh	72.9
Intersection LOS	F

Movement	EBL	EBT	EBR	WBL	WBT	WBR	NBL	NBT	NBR	SBL	SBT	SBR
Lane Configurations		↖	↗		↖	↗		↖	↗		↖	↗
Traffic Vol, veh/h	19	116	143	137	84	18	189	382	104	18	332	18
Future Vol, veh/h	19	116	143	137	84	18	189	382	104	18	332	18
Peak Hour Factor	0.97	0.97	0.97	0.97	0.97	0.97	0.97	0.97	0.97	0.97	0.97	0.97
Heavy Vehicles, %	0	0	2	0	0	0	0	1	0	0	0	0
Mvmt Flow	20	120	147	141	87	19	195	394	107	19	342	19
Number of Lanes	0	1	1	0	1	1	0	1	1	0	1	1

Approach	EB	WB	NB	SB
Opposing Approach	WB	EB	SB	NB
Opposing Lanes	2	2	2	2
Conflicting Approach Left	SB	NB	EB	WB
Conflicting Lanes Left	2	2	2	2
Conflicting Approach Right	NB	SB	WB	EB
Conflicting Lanes Right	2	2	2	2
HCM Control Delay	15.4	21.7	136.5	32.9
HCM LOS	C	C	F	D

Lane	NBLn1	NBLn2	EBLn1	EBLn2	WBLn1	WBLn2	SBLn1	SBLn2
Vol Left, %	33%	0%	14%	0%	62%	0%	5%	0%
Vol Thru, %	67%	0%	86%	0%	38%	0%	95%	0%
Vol Right, %	0%	100%	0%	100%	0%	100%	0%	100%
Sign Control	Stop	Stop	Stop	Stop	Stop	Stop	Stop	Stop
Traffic Vol by Lane	571	104	135	143	221	18	350	18
LT Vol	189	0	19	0	137	0	18	0
Through Vol	382	0	116	0	84	0	332	0
RT Vol	0	104	0	143	0	18	0	18
Lane Flow Rate	589	107	139	147	228	19	361	19
Geometry Grp	7	7	7	7	7	7	7	7
Degree of Util (X)	1.265	0.204	0.325	0.312	0.544	0.04	0.774	0.036
Departure Headway (Hd)	7.737	6.863	9.108	8.303	9.309	8.254	8.278	7.525
Convergence, Y/N	Yes	Yes	Yes	Yes	Yes	Yes	Yes	Yes
Cap	477	526	397	436	390	436	440	479
Service Time	5.438	4.565	6.808	6.003	7.009	5.954	5.978	5.225
HCM Lane V/C Ratio	1.235	0.203	0.35	0.337	0.585	0.044	0.82	0.04
HCM Control Delay	159.3	11.3	16.1	14.7	22.6	11.3	34.1	10.5
HCM Lane LOS	F	B	C	B	C	B	D	B
HCM 95th-tile Q	24.4	0.8	1.4	1.3	3.1	0.1	6.7	0.1

HCM 6th TWSC
 1: Silverado Trail & Crystal Springs Rd

03-26-2021

Intersection						
Int Delay, s/veh	0.4					
Movement	WBL	WBR	SEL	SET	NWT	NWR
Lane Configurations	T			T		
Traffic Vol, veh/h	10	6	8	325	403	1
Future Vol, veh/h	10	6	8	325	403	1
Conflicting Peds, #/hr	0	0	0	0	0	0
Sign Control	Stop	Stop	Free	Free	Free	Free
RT Channelized	-	None	-	None	-	None
Storage Length	0	-	-	-	-	-
Veh in Median Storage, #	0	-	-	0	0	-
Grade, %	0	-	-	0	0	-
Peak Hour Factor	95	95	95	95	95	95
Heavy Vehicles, %	0	0	0	0	1	0
Mvmt Flow	11	6	8	342	424	1

Major/Minor	Minor2	Major1	Major2			
Conflicting Flow All	783	425	425	0	-	0
Stage 1	425	-	-	-	-	-
Stage 2	358	-	-	-	-	-
Critical Hdwy	6.4	6.2	4.1	-	-	-
Critical Hdwy Stg 1	5.4	-	-	-	-	-
Critical Hdwy Stg 2	5.4	-	-	-	-	-
Follow-up Hdwy	3.5	3.3	2.2	-	-	-
Pot Cap-1 Maneuver	365	634	1145	-	-	-
Stage 1	664	-	-	-	-	-
Stage 2	712	-	-	-	-	-
Platoon blocked, %				-	-	-
Mov Cap-1 Maneuver	362	634	1145	-	-	-
Mov Cap-2 Maneuver	362	-	-	-	-	-
Stage 1	658	-	-	-	-	-
Stage 2	712	-	-	-	-	-

Approach	WB	SE	NW
HCM Control Delay, s	13.7	0.2	0
HCM LOS	B		

Minor Lane/Major Mvmt	NWT	NWRWBLn1	SEL	SET
Capacity (veh/h)	-	-	431	1145
HCM Lane V/C Ratio	-	-	0.039	0.007
HCM Control Delay (s)	-	-	13.7	8.2
HCM Lane LOS	-	-	B	A
HCM 95th %tile Q(veh)	-	-	0.1	0

HCM 6th TWSC
6: Deer Park Rd & Sanitarium Rd

03-26-2021

Intersection						
Int Delay, s/veh	3.2					
Movement	EBL	EBR	NBL	NBT	SBT	SBR
Lane Configurations						
Traffic Vol, veh/h	2	89	85	153	150	2
Future Vol, veh/h	2	89	85	153	150	2
Conflicting Peds, #/hr	0	0	0	0	0	0
Sign Control	Stop	Stop	Free	Free	Free	Free
RT Channelized	-	None	-	None	-	None
Storage Length	50	0	50	-	-	-
Veh in Median Storage, #	0	-	-	0	0	-
Grade, %	0	-	-	0	0	-
Peak Hour Factor	92	92	92	92	92	92
Heavy Vehicles, %	0	1	1	3	7	2
Mvmt Flow	2	97	92	166	163	2

Major/Minor	Minor2	Major1	Major2			
Conflicting Flow All	514	164	165	0	-	0
Stage 1	164	-	-	-	-	-
Stage 2	350	-	-	-	-	-
Critical Hdwy	6.4	6.21	4.11	-	-	-
Critical Hdwy Stg 1	5.4	-	-	-	-	-
Critical Hdwy Stg 2	5.4	-	-	-	-	-
Follow-up Hdwy	3.5	3.309	2.209	-	-	-
Pot Cap-1 Maneuver	524	883	1419	-	-	-
Stage 1	870	-	-	-	-	-
Stage 2	718	-	-	-	-	-
Platoon blocked, %				-	-	-
Mov Cap-1 Maneuver	490	883	1419	-	-	-
Mov Cap-2 Maneuver	490	-	-	-	-	-
Stage 1	813	-	-	-	-	-
Stage 2	718	-	-	-	-	-

Approach	EB	NB	SB
HCM Control Delay, s	9.7	2.8	0
HCM LOS	A		

Minor Lane/Major Mvmt	NBL	NBT	EBLn1	EBLn2	SBT	SBR
Capacity (veh/h)	1419	-	490	883	-	-
HCM Lane V/C Ratio	0.065	-	0.004	0.11	-	-
HCM Control Delay (s)	7.7	-	12.4	9.6	-	-
HCM Lane LOS	A	-	B	A	-	-
HCM 95th %tile Q(veh)	0.2	-	0	0.4	-	-

HCM 6th TWSC
7: Sanitarium Rd & Crystal Springs Rd

03-26-2021

Intersection						
Int Delay, s/veh	1.1					
Movement	NBL	NBT	SBT	SBR	SEL	SER
Lane Configurations		↶	↷		↶	↷
Traffic Vol, veh/h	11	85	109	4	7	10
Future Vol, veh/h	11	85	109	4	7	10
Conflicting Peds, #/hr	0	0	0	0	0	0
Sign Control	Free	Free	Free	Free	Stop	Stop
RT Channelized	-	None	-	None	-	None
Storage Length	-	-	-	-	0	-
Veh in Median Storage, #	-	0	0	-	0	-
Grade, %	-	0	0	-	0	-
Peak Hour Factor	85	85	85	85	85	85
Heavy Vehicles, %	0	6	3	0	0	0
Mvmt Flow	13	100	128	5	8	12

Major/Minor	Major1	Major2	Minor2		
Conflicting Flow All	133	0	-	0	257
Stage 1	-	-	-	-	131
Stage 2	-	-	-	-	126
Critical Hdwy	4.1	-	-	-	6.4
Critical Hdwy Stg 1	-	-	-	-	5.4
Critical Hdwy Stg 2	-	-	-	-	5.4
Follow-up Hdwy	2.2	-	-	-	3.5
Pot Cap-1 Maneuver	1464	-	-	-	736
Stage 1	-	-	-	-	900
Stage 2	-	-	-	-	905
Platoon blocked, %		-	-	-	
Mov Cap-1 Maneuver	1464	-	-	-	729
Mov Cap-2 Maneuver	-	-	-	-	729
Stage 1	-	-	-	-	892
Stage 2	-	-	-	-	905

Approach	NB	SB	SE
HCM Control Delay, s	0.9	0	9.4
HCM LOS			A

Minor Lane/Major Mvmt	NBL	NBT	SELn1	SBT	SBR
Capacity (veh/h)	1464	-	832	-	-
HCM Lane V/C Ratio	0.009	-	0.024	-	-
HCM Control Delay (s)	7.5	0	9.4	-	-
HCM Lane LOS	A	A	A	-	-
HCM 95th %tile Q(veh)	0	-	0.1	-	-

HCM 6th TWSC
 9: Project Dwy & Crystal Springs Rd/Crystal Springs

03-26-2021

Intersection						
Int Delay, s/veh	2.2					
Movement	SET	SER	NWL	NWT	NEL	NER
Lane Configurations						
Traffic Vol, veh/h	4	2	1	8	3	1
Future Vol, veh/h	4	2	1	8	3	1
Conflicting Peds, #/hr	0	0	0	0	0	0
Sign Control	Free	Free	Free	Free	Stop	Stop
RT Channelized	-	None	-	None	-	None
Storage Length	-	-	-	-	0	-
Veh in Median Storage, #	0	-	-	0	0	-
Grade, %	0	-	-	0	0	-
Peak Hour Factor	70	70	70	70	70	70
Heavy Vehicles, %	0	0	0	0	0	0
Mvmt Flow	6	3	1	11	4	1

Major/Minor	Major1	Major2	Minor1		
Conflicting Flow All	0	0	9	0	21 8
Stage 1	-	-	-	-	8 -
Stage 2	-	-	-	-	13 -
Critical Hdwy	-	-	4.1	-	6.4 6.2
Critical Hdwy Stg 1	-	-	-	-	5.4 -
Critical Hdwy Stg 2	-	-	-	-	5.4 -
Follow-up Hdwy	-	-	2.2	-	3.5 3.3
Pot Cap-1 Maneuver	-	-	1624	-	1001 1080
Stage 1	-	-	-	-	1020 -
Stage 2	-	-	-	-	1015 -
Platoon blocked, %	-	-	-	-	-
Mov Cap-1 Maneuver	-	-	1624	-	1000 1080
Mov Cap-2 Maneuver	-	-	-	-	1000 -
Stage 1	-	-	-	-	1020 -
Stage 2	-	-	-	-	1014 -

Approach	SE	NW	NE
HCM Control Delay, s	0	0.8	8.6
HCM LOS			A

Minor Lane/Major Mvmt	NELn1	NWL	NWT	SET	SER
Capacity (veh/h)	1019	1624	-	-	-
HCM Lane V/C Ratio	0.006	0.001	-	-	-
HCM Control Delay (s)	8.6	7.2	0	-	-
HCM Lane LOS	A	A	A	-	-
HCM 95th %tile Q(veh)	0	0	-	-	-

Intersection

Int Delay, s/veh 2.7

Movement	EBL	EBT	WBT	WBR	SBL	SBR
Lane Configurations		↕	↕		↕	
Traffic Vol, veh/h	4	6	11	0	0	5
Future Vol, veh/h	4	6	11	0	0	5
Conflicting Peds, #/hr	0	0	0	0	0	0
Sign Control	Free	Free	Free	Free	Stop	Stop
RT Channelized	-	None	-	None	-	None
Storage Length	-	-	-	-	0	-
Veh in Median Storage, #	-	0	0	-	0	-
Grade, %	-	0	0	-	0	-
Peak Hour Factor	80	80	80	80	80	80
Heavy Vehicles, %	2	2	2	2	2	2
Mvmt Flow	5	8	14	0	0	6

Major/Minor	Major1	Major2	Minor2		
Conflicting Flow All	14	0	-	0	32 14
Stage 1	-	-	-	-	14 -
Stage 2	-	-	-	-	18 -
Critical Hdwy	4.12	-	-	-	6.42 6.22
Critical Hdwy Stg 1	-	-	-	-	5.42 -
Critical Hdwy Stg 2	-	-	-	-	5.42 -
Follow-up Hdwy	2.218	-	-	-	3.518 3.318
Pot Cap-1 Maneuver	1604	-	-	-	982 1066
Stage 1	-	-	-	-	1009 -
Stage 2	-	-	-	-	1005 -
Platoon blocked, %		-	-	-	
Mov Cap-1 Maneuver	1604	-	-	-	979 1066
Mov Cap-2 Maneuver	-	-	-	-	979 -
Stage 1	-	-	-	-	1006 -
Stage 2	-	-	-	-	1005 -

Approach	EB	WB	SB
HCM Control Delay, s	2.9	0	8.4
HCM LOS			A

Minor Lane/Major Mvmt	EBL	EBT	WBT	WBR	SBLn1
Capacity (veh/h)	1604	-	-	-	1066
HCM Lane V/C Ratio	0.003	-	-	-	0.006
HCM Control Delay (s)	7.3	0	-	-	8.4
HCM Lane LOS	A	A	-	-	A
HCM 95th %tile Q(veh)	0	-	-	-	0

HCM 6th AWSC
2: Silverado Trail & Deer Park Rd

03-26-2021

Intersection	
Intersection Delay, s/veh	145.9
Intersection LOS	F

Movement	EBL	EBT	EBR	WBL	WBT	WBR	NBL	NBT	NBR	SBL	SBT	SBR
Lane Configurations		↖	↗		↖	↗		↖	↗		↖	↗
Traffic Vol, veh/h	31	240	345	256	110	30	135	416	116	10	417	26
Future Vol, veh/h	31	240	345	256	110	30	135	416	116	10	417	26
Peak Hour Factor	0.94	0.94	0.94	0.94	0.94	0.94	0.94	0.94	0.94	0.94	0.94	0.94
Heavy Vehicles, %	0	0	2	0	0	0	0	1	0	0	0	0
Mvmt Flow	33	255	367	272	117	32	144	443	123	11	444	28
Number of Lanes	0	1	1	0	1	1	0	1	1	0	1	1

Approach	EB	WB	NB	SB
Opposing Approach	WB	EB	SB	NB
Opposing Lanes	2	2	2	2
Conflicting Approach Left	SB	NB	EB	WB
Conflicting Lanes Left	2	2	2	2
Conflicting Approach Right	NB	SB	WB	EB
Conflicting Lanes Right	2	2	2	2
HCM Control Delay	55.7	103.2	253.1	148.1
HCM LOS	F	F	F	F

Lane	NBLn1	NBLn2	EBLn1	EBLn2	WBLn1	WBLn2	SBLn1	SBLn2
Vol Left, %	25%	0%	11%	0%	70%	0%	2%	0%
Vol Thru, %	75%	0%	89%	0%	30%	0%	98%	0%
Vol Right, %	0%	100%	0%	100%	0%	100%	0%	100%
Sign Control	Stop	Stop	Stop	Stop	Stop	Stop	Stop	Stop
Traffic Vol by Lane	551	116	271	345	366	30	427	26
LT Vol	135	0	31	0	256	0	10	0
Through Vol	416	0	240	0	110	0	417	0
RT Vol	0	116	0	345	0	30	0	26
Lane Flow Rate	586	123	288	367	389	32	454	28
Geometry Grp	7	7	7	7	7	7	7	7
Degree of Util (X)	1.585	0.306	0.781	0.917	1.083	0.079	1.222	0.069
Departure Headway (Hd)	10.664	9.809	11.522	10.711	11.615	10.493	11.062	10.303
Convergence, Y/N	Yes	Yes	Yes	Yes	Yes	Yes	Yes	Yes
Cap	346	369	317	341	315	344	332	350
Service Time	8.364	7.509	9.222	8.411	9.315	8.193	8.762	8.003
HCM Lane V/C Ratio	1.694	0.333	0.909	1.076	1.235	0.093	1.367	0.08
HCM Control Delay	302.9	16.8	45.4	63.8	110.5	14.1	156.3	13.8
HCM Lane LOS	F	C	E	F	F	B	F	B
HCM 95th-tile Q	31.1	1.3	6.2	9.1	12.9	0.3	17.5	0.2

HCM 6th TWSC
 1: Silverado Trail & Crystal Springs Rd

03-26-2021

Intersection						
Int Delay, s/veh	0.7					
Movement	WBL	WBR	SEL	SET	NWT	NWR
Lane Configurations	T			L		R
Traffic Vol, veh/h	20	10	13	389	450	9
Future Vol, veh/h	20	10	13	389	450	9
Conflicting Peds, #/hr	0	0	0	0	0	0
Sign Control	Stop	Stop	Free	Free	Free	Free
RT Channelized	-	None	-	None	-	None
Storage Length	0	-	-	-	-	-
Veh in Median Storage, #	0	-	-	0	0	-
Grade, %	0	-	-	0	0	-
Peak Hour Factor	87	87	87	87	87	87
Heavy Vehicles, %	0	0	0	0	1	0
Mvmt Flow	23	11	15	447	517	10

Major/Minor	Minor2	Major1	Major2			
Conflicting Flow All	999	522	527	0	-	0
Stage 1	522	-	-	-	-	-
Stage 2	477	-	-	-	-	-
Critical Hdwy	6.4	6.2	4.1	-	-	-
Critical Hdwy Stg 1	5.4	-	-	-	-	-
Critical Hdwy Stg 2	5.4	-	-	-	-	-
Follow-up Hdwy	3.5	3.3	2.2	-	-	-
Pot Cap-1 Maneuver	272	559	1050	-	-	-
Stage 1	599	-	-	-	-	-
Stage 2	629	-	-	-	-	-
Platoon blocked, %				-	-	-
Mov Cap-1 Maneuver	267	559	1050	-	-	-
Mov Cap-2 Maneuver	267	-	-	-	-	-
Stage 1	588	-	-	-	-	-
Stage 2	629	-	-	-	-	-

Approach	WB	SE	NW
HCM Control Delay, s	17.5	0.3	0
HCM LOS	C		

Minor Lane/Major Mvmt	NWT	NWRWBLn1	SEL	SET
Capacity (veh/h)	-	-	323	1050
HCM Lane V/C Ratio	-	-	0.107	0.014
HCM Control Delay (s)	-	-	17.5	8.5
HCM Lane LOS	-	-	C	A
HCM 95th %tile Q(veh)	-	-	0.4	0

HCM 6th TWSC
6: Deer Park Rd & Sanitarium Rd

03-26-2021

Intersection						
Int Delay, s/veh	4.2					
Movement	EBL	EBR	NBL	NBT	SBT	SBR
Lane Configurations						
Traffic Vol, veh/h	3	186	135	236	210	3
Future Vol, veh/h	3	186	135	236	210	3
Conflicting Peds, #/hr	0	0	0	0	0	0
Sign Control	Stop	Stop	Free	Free	Free	Free
RT Channelized	-	Yield	-	None	-	None
Storage Length	55	0	100	-	-	-
Veh in Median Storage, #	0	-	-	0	0	-
Grade, %	0	-	-	0	0	-
Peak Hour Factor	88	88	88	88	88	88
Heavy Vehicles, %	0	4	2	3	6	0
Mvmt Flow	3	211	153	268	239	3

Major/Minor	Minor2	Major1		Major2	
Conflicting Flow All	815	241	242	0	0
Stage 1	241	-	-	-	-
Stage 2	574	-	-	-	-
Critical Hdwy	6.4	6.24	4.12	-	-
Critical Hdwy Stg 1	5.4	-	-	-	-
Critical Hdwy Stg 2	5.4	-	-	-	-
Follow-up Hdwy	3.5	3.336	2.218	-	-
Pot Cap-1 Maneuver	350	793	1324	-	-
Stage 1	804	-	-	-	-
Stage 2	567	-	-	-	-
Platoon blocked, %				-	-
Mov Cap-1 Maneuver	309	793	1324	-	-
Mov Cap-2 Maneuver	309	-	-	-	-
Stage 1	711	-	-	-	-
Stage 2	567	-	-	-	-

Approach	EB	NB	SB
HCM Control Delay, s	11.3	2.9	0
HCM LOS	B		

Minor Lane/Major Mvmt	NBL	NBT	EBLn1	EBLn2	SBT	SBR
Capacity (veh/h)	1324	-	309	793	-	-
HCM Lane V/C Ratio	0.116	-	0.011	0.267	-	-
HCM Control Delay (s)	8.1	-	16.8	11.2	-	-
HCM Lane LOS	A	-	C	B	-	-
HCM 95th %tile Q(veh)	0.4	-	0	1.1	-	-

HCM 6th TWSC
7: Sanitarium Rd & Crystal Springs Rd

03-26-2021

Intersection						
Int Delay, s/veh	0.9					
Movement	NBL	NBT	SBT	SBR	SEL	SER
Lane Configurations		↶	↷		↶	↷
Traffic Vol, veh/h	16	144	219	4	8	13
Future Vol, veh/h	16	144	219	4	8	13
Conflicting Peds, #/hr	0	0	0	0	0	0
Sign Control	Free	Free	Free	Free	Stop	Stop
RT Channelized	-	None	-	None	-	None
Storage Length	-	-	-	-	0	-
Veh in Median Storage, #	-	0	0	-	0	-
Grade, %	-	0	0	-	0	-
Peak Hour Factor	88	88	88	88	88	88
Heavy Vehicles, %	0	1	2	0	0	0
Mvmt Flow	18	164	249	5	9	15

Major/Minor	Major1	Major2	Minor2		
Conflicting Flow All	254	0	-	0	452 252
Stage 1	-	-	-	-	252 -
Stage 2	-	-	-	-	200 -
Critical Hdwy	4.1	-	-	-	6.4 6.2
Critical Hdwy Stg 1	-	-	-	-	5.4 -
Critical Hdwy Stg 2	-	-	-	-	5.4 -
Follow-up Hdwy	2.2	-	-	-	3.5 3.3
Pot Cap-1 Maneuver	1323	-	-	-	569 792
Stage 1	-	-	-	-	795 -
Stage 2	-	-	-	-	838 -
Platoon blocked, %		-	-	-	
Mov Cap-1 Maneuver	1323	-	-	-	560 792
Mov Cap-2 Maneuver	-	-	-	-	560 -
Stage 1	-	-	-	-	783 -
Stage 2	-	-	-	-	838 -

Approach	NB	SB	SE
HCM Control Delay, s	0.8	0	10.5
HCM LOS			B

Minor Lane/Major Mvmt	NBL	NBT	SELn1	SBT	SBR
Capacity (veh/h)	1323	-	684	-	-
HCM Lane V/C Ratio	0.014	-	0.035	-	-
HCM Control Delay (s)	7.8	0	10.5	-	-
HCM Lane LOS	A	A	B	-	-
HCM 95th %tile Q(veh)	0	-	0.1	-	-

HCM 6th TWSC
 9: Project Dwy & Crystal Springs Rd/Crystal Springs

03-26-2021

Intersection						
Int Delay, s/veh	1.7					
Movement	SET	SER	NWL	NWT	NEL	NER
Lane Configurations						
Traffic Vol, veh/h	11	4	1	9	4	1
Future Vol, veh/h	11	4	1	9	4	1
Conflicting Peds, #/hr	0	0	0	0	0	0
Sign Control	Free	Free	Free	Free	Stop	Stop
RT Channelized	-	None	-	None	-	None
Storage Length	-	-	-	-	0	-
Veh in Median Storage, #	0	-	-	0	0	-
Grade, %	0	-	-	0	0	-
Peak Hour Factor	70	70	70	70	70	70
Heavy Vehicles, %	0	0	0	0	0	0
Mvmt Flow	16	6	1	13	6	1

Major/Minor	Major1	Major2	Minor1	Minor2	Minor3
Conflicting Flow All	0	0	22	0	34
Stage 1	-	-	-	-	19
Stage 2	-	-	-	-	15
Critical Hdwy	-	-	4.1	-	6.4
Critical Hdwy Stg 1	-	-	-	-	5.4
Critical Hdwy Stg 2	-	-	-	-	5.4
Follow-up Hdwy	-	-	2.2	-	3.5
Pot Cap-1 Maneuver	-	-	1607	-	984
Stage 1	-	-	-	-	1009
Stage 2	-	-	-	-	1013
Platoon blocked, %	-	-	-	-	-
Mov Cap-1 Maneuver	-	-	1607	-	983
Mov Cap-2 Maneuver	-	-	-	-	983
Stage 1	-	-	-	-	1009
Stage 2	-	-	-	-	1012

Approach	SE	NW	NE
HCM Control Delay, s	0	0.7	8.6
HCM LOS			A

Minor Lane/Major Mvmt	NELn1	NWL	NWT	SET	SER
Capacity (veh/h)	998	1607	-	-	-
HCM Lane V/C Ratio	0.007	0.001	-	-	-
HCM Control Delay (s)	8.6	7.2	0	-	-
HCM Lane LOS	A	A	A	-	-
HCM 95th %tile Q(veh)	0	0	-	-	-

Intersection						
Int Delay, s/veh	4.1					
Movement	EBL	EBT	WBT	WBR	SBL	SBR
Lane Configurations		↶	↷		↶	
Traffic Vol, veh/h	7	15	12	1	3	18
Future Vol, veh/h	7	15	12	1	3	18
Conflicting Peds, #/hr	0	0	0	0	0	0
Sign Control	Free	Free	Free	Free	Stop	Stop
RT Channelized	-	None	-	None	-	None
Storage Length	-	-	-	-	0	-
Veh in Median Storage, #	-	0	0	-	0	-
Grade, %	-	0	0	-	0	-
Peak Hour Factor	80	80	80	80	80	80
Heavy Vehicles, %	0	0	0	0	0	0
Mvmt Flow	9	19	15	1	4	23

Major/Minor	Major1	Major2	Minor2		
Conflicting Flow All	16	0	-	0	53
Stage 1	-	-	-	-	16
Stage 2	-	-	-	-	37
Critical Hdwy	4.1	-	-	-	6.4
Critical Hdwy Stg 1	-	-	-	-	5.4
Critical Hdwy Stg 2	-	-	-	-	5.4
Follow-up Hdwy	2.2	-	-	-	3.5
Pot Cap-1 Maneuver	1615	-	-	-	960
Stage 1	-	-	-	-	1012
Stage 2	-	-	-	-	991
Platoon blocked, %		-	-	-	
Mov Cap-1 Maneuver	1615	-	-	-	954
Mov Cap-2 Maneuver	-	-	-	-	954
Stage 1	-	-	-	-	1006
Stage 2	-	-	-	-	991

Approach	EB	WB	SB
HCM Control Delay, s	2.3	0	8.5
HCM LOS			A

Minor Lane/Major Mvmt	EBL	EBT	WBT	WBR	SBLn1
Capacity (veh/h)	1615	-	-	-	1051
HCM Lane V/C Ratio	0.005	-	-	-	0.025
HCM Control Delay (s)	7.2	0	-	-	8.5
HCM Lane LOS	A	A	-	-	A
HCM 95th %tile Q(veh)	0	-	-	-	0.1

HCM 6th AWSC
2: Silverado Trail & Deer Park Rd

03-26-2021

Intersection	
Intersection Delay, s/veh	107.8
Intersection LOS	F

Movement	EBL	EBT	EBR	WBL	WBT	WBR	NBL	NBT	NBR	SBL	SBT	SBR
Lane Configurations		↖	↗		↖	↗		↖	↗		↖	↗
Traffic Vol, veh/h	21	124	154	143	89	19	203	425	110	20	371	24
Future Vol, veh/h	21	124	154	143	89	19	203	425	110	20	371	24
Peak Hour Factor	0.97	0.97	0.97	0.97	0.97	0.97	0.97	0.97	0.97	0.97	0.97	0.97
Heavy Vehicles, %	0	0	2	0	0	0	0	1	0	0	0	0
Mvmt Flow	22	128	159	147	92	20	209	438	113	21	382	25
Number of Lanes	0	1	1	0	1	1	0	1	1	0	1	1

Approach	EB	WB	NB	SB
Opposing Approach	WB	EB	SB	NB
Opposing Lanes	2	2	2	2
Conflicting Approach Left	SB	NB	EB	WB
Conflicting Lanes Left	2	2	2	2
Conflicting Approach Right	NB	SB	WB	EB
Conflicting Lanes Right	2	2	2	2
HCM Control Delay	17	25	205.2	49.9
HCM LOS	C	C	F	E

Lane	NBLn1	NBLn2	EBLn1	EBLn2	WBLn1	WBLn2	SBLn1	SBLn2
Vol Left, %	32%	0%	14%	0%	62%	0%	5%	0%
Vol Thru, %	68%	0%	86%	0%	38%	0%	95%	0%
Vol Right, %	0%	100%	0%	100%	0%	100%	0%	100%
Sign Control	Stop	Stop	Stop	Stop	Stop	Stop	Stop	Stop
Traffic Vol by Lane	628	110	145	154	232	19	391	24
LT Vol	203	0	21	0	143	0	20	0
Through Vol	425	0	124	0	89	0	371	0
RT Vol	0	110	0	154	0	19	0	24
Lane Flow Rate	647	113	149	159	239	20	403	25
Geometry Grp	7	7	7	7	7	7	7	7
Degree of Util (X)	1.455	0.227	0.364	0.352	0.595	0.043	0.898	0.05
Departure Headway (Hd)	8.092	7.219	9.697	8.884	9.893	8.833	8.765	8.009
Convergence, Y/N	Yes	Yes	Yes	Yes	Yes	Yes	Yes	Yes
Cap	453	497	374	408	368	408	415	450
Service Time	5.848	4.975	7.397	6.584	7.593	6.533	6.465	5.709
HCM Lane V/C Ratio	1.428	0.227	0.398	0.39	0.649	0.049	0.971	0.056
HCM Control Delay	239	12.1	17.8	16.3	26.1	11.9	52.3	11.1
HCM Lane LOS	F	B	C	C	D	B	F	B
HCM 95th-tile Q	32.5	0.9	1.6	1.6	3.7	0.1	9.4	0.2

HCM 6th TWSC
 1: Silverado Trail & Crystal Springs Rd

03-26-2021

Intersection						
Int Delay, s/veh	0.4					
Movement	WBL	WBR	SEL	SET	NWT	NWR
Lane Configurations	T			T		T
Traffic Vol, veh/h	11	6	8	361	443	2
Future Vol, veh/h	11	6	8	361	443	2
Conflicting Peds, #/hr	0	0	0	0	0	0
Sign Control	Stop	Stop	Free	Free	Free	Free
RT Channelized	-	None	-	None	-	None
Storage Length	0	-	-	-	-	-
Veh in Median Storage, #	0	-	-	0	0	-
Grade, %	0	-	-	0	0	-
Peak Hour Factor	95	95	95	95	95	95
Heavy Vehicles, %	0	0	0	0	1	0
Mvmt Flow	12	6	8	380	466	2

Major/Minor	Minor2	Major1	Major2			
Conflicting Flow All	863	467	468	0	-	0
Stage 1	467	-	-	-	-	-
Stage 2	396	-	-	-	-	-
Critical Hdwy	6.4	6.2	4.1	-	-	-
Critical Hdwy Stg 1	5.4	-	-	-	-	-
Critical Hdwy Stg 2	5.4	-	-	-	-	-
Follow-up Hdwy	3.5	3.3	2.2	-	-	-
Pot Cap-1 Maneuver	328	600	1104	-	-	-
Stage 1	635	-	-	-	-	-
Stage 2	684	-	-	-	-	-
Platoon blocked, %				-	-	-
Mov Cap-1 Maneuver	325	600	1104	-	-	-
Mov Cap-2 Maneuver	325	-	-	-	-	-
Stage 1	629	-	-	-	-	-
Stage 2	684	-	-	-	-	-

Approach	WB	SE	NW
HCM Control Delay, s	14.7	0.2	0
HCM LOS	B		

Minor Lane/Major Mvmt	NWT	NWRWBLn1	SEL	SET
Capacity (veh/h)	-	-	388	1104
HCM Lane V/C Ratio	-	-	0.046	0.008
HCM Control Delay (s)	-	-	14.7	8.3
HCM Lane LOS	-	-	B	A
HCM 95th %tile Q(veh)	-	-	0.1	0

HCM 6th TWSC
6: Deer Park Rd & Sanitarium Rd

03-26-2021

Intersection						
Int Delay, s/veh	3.2					
Movement	EBL	EBR	NBL	NBT	SBT	SBR
Lane Configurations	↶	↷	↶	↶	↷	↷
Traffic Vol, veh/h	3	94	90	164	157	3
Future Vol, veh/h	3	94	90	164	157	3
Conflicting Peds, #/hr	0	0	0	0	0	0
Sign Control	Stop	Stop	Free	Free	Free	Free
RT Channelized	-	None	-	None	-	None
Storage Length	50	0	50	-	-	-
Veh in Median Storage, #	0	-	-	0	0	-
Grade, %	0	-	-	0	0	-
Peak Hour Factor	92	92	92	92	92	92
Heavy Vehicles, %	0	1	1	3	7	2
Mvmt Flow	3	102	98	178	171	3

Major/Minor	Minor2	Major1		Major2	
Conflicting Flow All	547	173	174	0	0
Stage 1	173	-	-	-	-
Stage 2	374	-	-	-	-
Critical Hdwy	6.4	6.21	4.11	-	-
Critical Hdwy Stg 1	5.4	-	-	-	-
Critical Hdwy Stg 2	5.4	-	-	-	-
Follow-up Hdwy	3.5	3.309	2.209	-	-
Pot Cap-1 Maneuver	502	873	1409	-	-
Stage 1	862	-	-	-	-
Stage 2	700	-	-	-	-
Platoon blocked, %				-	-
Mov Cap-1 Maneuver	467	873	1409	-	-
Mov Cap-2 Maneuver	467	-	-	-	-
Stage 1	802	-	-	-	-
Stage 2	700	-	-	-	-

Approach	EB	NB	SB
HCM Control Delay, s	9.8	2.7	0
HCM LOS	A		

Minor Lane/Major Mvmt	NBL	NBT	EBLn1	EBLn2	SBT	SBR
Capacity (veh/h)	1409	-	467	873	-	-
HCM Lane V/C Ratio	0.069	-	0.007	0.117	-	-
HCM Control Delay (s)	7.7	-	12.8	9.7	-	-
HCM Lane LOS	A	-	B	A	-	-
HCM 95th %tile Q(veh)	0.2	-	0	0.4	-	-

HCM 6th TWSC
7: Sanitarium Rd & Crystal Springs Rd

03-26-2021

Intersection						
Int Delay, s/veh	1.1					
Movement	NBL	NBT	SBT	SBR	SEL	SER
Lane Configurations		↶	↷		↶	↷
Traffic Vol, veh/h	12	91	115	5	8	11
Future Vol, veh/h	12	91	115	5	8	11
Conflicting Peds, #/hr	0	0	0	0	0	0
Sign Control	Free	Free	Free	Free	Stop	Stop
RT Channelized	-	None	-	None	-	None
Storage Length	-	-	-	-	0	-
Veh in Median Storage, #	-	0	0	-	0	-
Grade, %	-	0	0	-	0	-
Peak Hour Factor	85	85	85	85	85	85
Heavy Vehicles, %	0	6	3	0	0	0
Mvmt Flow	14	107	135	6	9	13

Major/Minor	Major1	Major2	Minor2		
Conflicting Flow All	141	0	0	273	138
Stage 1	-	-	-	138	-
Stage 2	-	-	-	135	-
Critical Hdwy	4.1	-	-	6.4	6.2
Critical Hdwy Stg 1	-	-	-	5.4	-
Critical Hdwy Stg 2	-	-	-	5.4	-
Follow-up Hdwy	2.2	-	-	3.5	3.3
Pot Cap-1 Maneuver	1455	-	-	721	916
Stage 1	-	-	-	894	-
Stage 2	-	-	-	896	-
Platoon blocked, %	-	-	-	-	-
Mov Cap-1 Maneuver	1455	-	-	714	916
Mov Cap-2 Maneuver	-	-	-	714	-
Stage 1	-	-	-	885	-
Stage 2	-	-	-	896	-

Approach	NB	SB	SE
HCM Control Delay, s	0.9	0	9.5
HCM LOS			A

Minor Lane/Major Mvmt	NBL	NBT	SELn1	SBT	SBR
Capacity (veh/h)	1455	-	818	-	-
HCM Lane V/C Ratio	0.01	-	0.027	-	-
HCM Control Delay (s)	7.5	0	9.5	-	-
HCM Lane LOS	A	A	A	-	-
HCM 95th %tile Q(veh)	0	-	0.1	-	-

HCM 6th TWSC
 9: Project Dwy & Crystal Springs Rd/Crystal Springs

03-26-2021

Intersection						
Int Delay, s/veh	2.4					
Movement	SET	SER	NWL	NWT	NEL	NER
Lane Configurations						
Traffic Vol, veh/h	5	2	1	8	3	2
Future Vol, veh/h	5	2	1	8	3	2
Conflicting Peds, #/hr	0	0	0	0	0	0
Sign Control	Free	Free	Free	Free	Stop	Stop
RT Channelized	-	None	-	None	-	None
Storage Length	-	-	-	-	0	-
Veh in Median Storage, #	0	-	-	0	0	-
Grade, %	0	-	-	0	0	-
Peak Hour Factor	70	70	70	70	70	70
Heavy Vehicles, %	0	0	0	0	0	0
Mvmt Flow	7	3	1	11	4	3

Major/Minor	Major1	Major2	Minor1	Minor2	Minor3
Conflicting Flow All	0	0	10	0	22
Stage 1	-	-	-	-	9
Stage 2	-	-	-	-	13
Critical Hdwy	-	-	4.1	-	6.4
Critical Hdwy Stg 1	-	-	-	-	5.4
Critical Hdwy Stg 2	-	-	-	-	5.4
Follow-up Hdwy	-	-	2.2	-	3.5
Pot Cap-1 Maneuver	-	-	1623	-	1000
Stage 1	-	-	-	-	1019
Stage 2	-	-	-	-	1015
Platoon blocked, %	-	-	-	-	-
Mov Cap-1 Maneuver	-	-	1623	-	999
Mov Cap-2 Maneuver	-	-	-	-	999
Stage 1	-	-	-	-	1019
Stage 2	-	-	-	-	1014

Approach	SE	NW	NE
HCM Control Delay, s	0	0.8	8.5
HCM LOS			A

Minor Lane/Major Mvmt	NELn1	NWL	NWT	SET	SER
Capacity (veh/h)	1030	1623	-	-	-
HCM Lane V/C Ratio	0.007	0.001	-	-	-
HCM Control Delay (s)	8.5	7.2	0	-	-
HCM Lane LOS	A	A	A	-	-
HCM 95th %tile Q(veh)	0	0	-	-	-

Intersection

Int Delay, s/veh 2.8

Movement EBL EBT WBT WBR SBL SBR

Lane Configurations		↶	↷		↶	
Traffic Vol, veh/h	5	6	12	0	0	5
Future Vol, veh/h	5	6	12	0	0	5
Conflicting Peds, #/hr	0	0	0	0	0	0
Sign Control	Free	Free	Free	Free	Stop	Stop
RT Channelized	-	None	-	None	-	None
Storage Length	-	-	-	-	0	-
Veh in Median Storage, #	-	0	0	-	0	-
Grade, %	-	0	0	-	0	-
Peak Hour Factor	80	80	80	80	80	80
Heavy Vehicles, %	2	2	2	2	2	2
Mvmt Flow	6	8	15	0	0	6

Major/Minor Major1 Major2 Minor2

Conflicting Flow All	15	0	-	0	35	15
Stage 1	-	-	-	-	15	-
Stage 2	-	-	-	-	20	-
Critical Hdwy	4.12	-	-	-	6.42	6.22
Critical Hdwy Stg 1	-	-	-	-	5.42	-
Critical Hdwy Stg 2	-	-	-	-	5.42	-
Follow-up Hdwy	2.218	-	-	-	3.518	3.318
Pot Cap-1 Maneuver	1603	-	-	-	978	1065
Stage 1	-	-	-	-	1008	-
Stage 2	-	-	-	-	1003	-
Platoon blocked, %		-	-	-		
Mov Cap-1 Maneuver	1603	-	-	-	974	1065
Mov Cap-2 Maneuver	-	-	-	-	974	-
Stage 1	-	-	-	-	1004	-
Stage 2	-	-	-	-	1003	-

Approach EB WB SB

HCM Control Delay, s	3.3	0	8.4
HCM LOS			A

Minor Lane/Major Mvmt EBL EBT WBT WBR SBLn1

Capacity (veh/h)	1603	-	-	-	1065
HCM Lane V/C Ratio	0.004	-	-	-	0.006
HCM Control Delay (s)	7.3	0	-	-	8.4
HCM Lane LOS	A	A	-	-	A
HCM 95th %tile Q(veh)	0	-	-	-	0

**A
P
P
E
N
D
I
X

C**

CALTRANS PEAK HOUR SIGNAL WARRANT #3 (Rural Area)

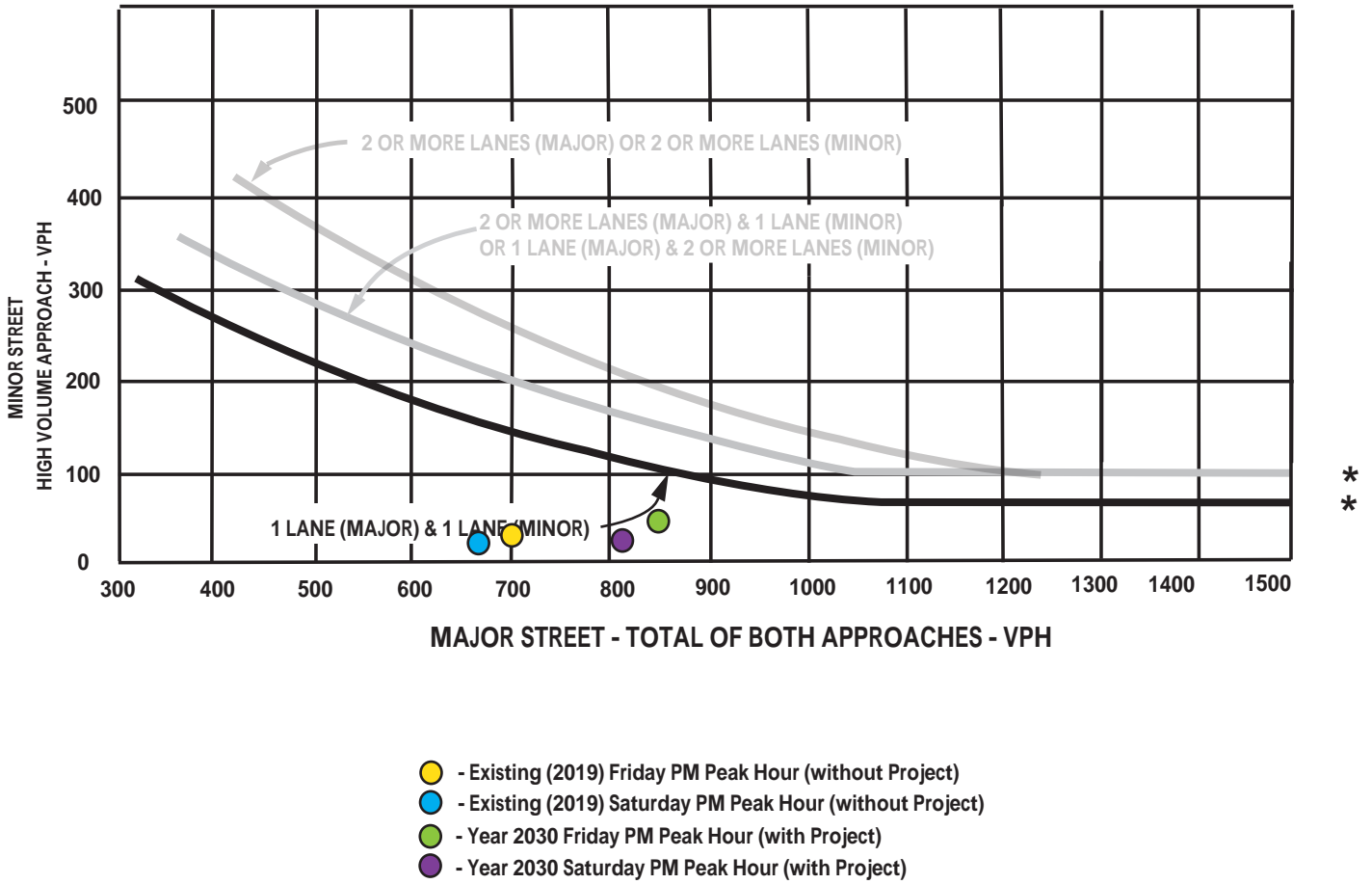

*** NOTE**

100 VPH APPLIES AS THE LOWER THRESHOLD VOLUME FOR A MINOR STREET APPROACH WITH TWO OR MORE LANES AND 75 VPH APPLIES AS THE LOWER THRESHOLD VOLUME FOR A MINOR STREET APPROACH WITH ONE LANE

Source: California 2014 Manual on Uniform Traffic Control Devices

Figure C-1
PEAK HOUR SIGNAL WARRANT #3
(Rural Area)
Silverado Trail/Crystal Springs Rd



CALTRANS PEAK HOUR SIGNAL WARRANT #3 (Rural Area)

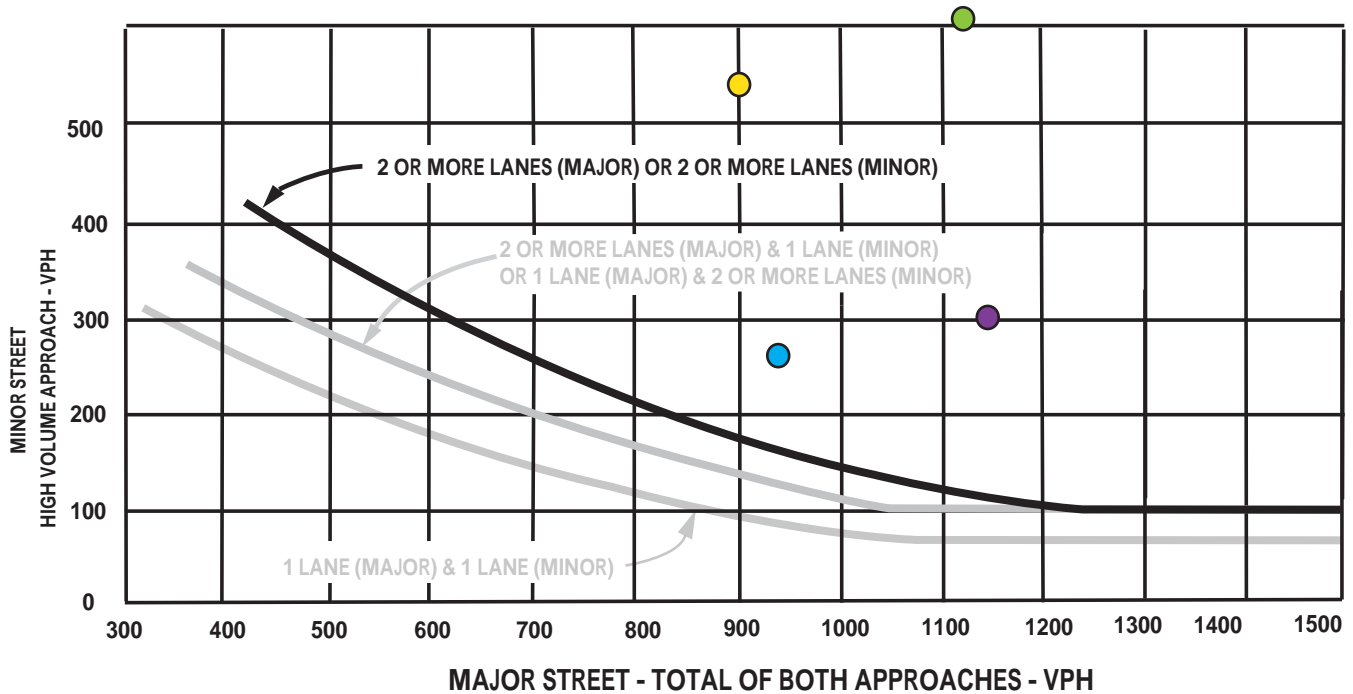

*
*

- - Existing (2019) Friday PM Peak Hour (without Project)
- - Existing (2019) Saturday PM Peak Hour (without Project)
- - Year 2030 Friday PM Peak Hour (with Project)
- - Year 2030 Saturday PM Peak Hour (with Project)

*** NOTE**

100 VPH APPLIES AS THE LOWER THRESHOLD VOLUME FOR A MINOR STREET APPROACH WITH TWO OR MORE LANES AND 75 VPH APPLIES AS THE LOWER THRESHOLD VOLUME FOR A MINOR STREET APPROACH WITH ONE LANE

Source: California 2014 Manual on Uniform Traffic Control Devices

Figure C-2
PEAK HOUR SIGNAL WARRANT #3
(Rural Area)
Silverado Trail/Deer Park Rd



A P P E N D I X D

Not To Scale

 NORTH

	# of veh	Cause	Type	Injury
1	1	object on road	hit object	no
2	2	improper pass	sideswipe	no
3	1	unsafe turn	hit object	yes
4	2	unsafe speed	rear end	yes
5	2	unsafe speed	sideswipe	no
6	1	unsafe turn	hit object	yes
7	2	unsafe speed	rear end	no
8	2	unsafe speed	overturn	yes
9	2	unsafe speed	rear end	no
10	1	improper pass	hit object	no

Accidents 7 & 8 are at
 Silverado Trail/Lodi Ln Intersection

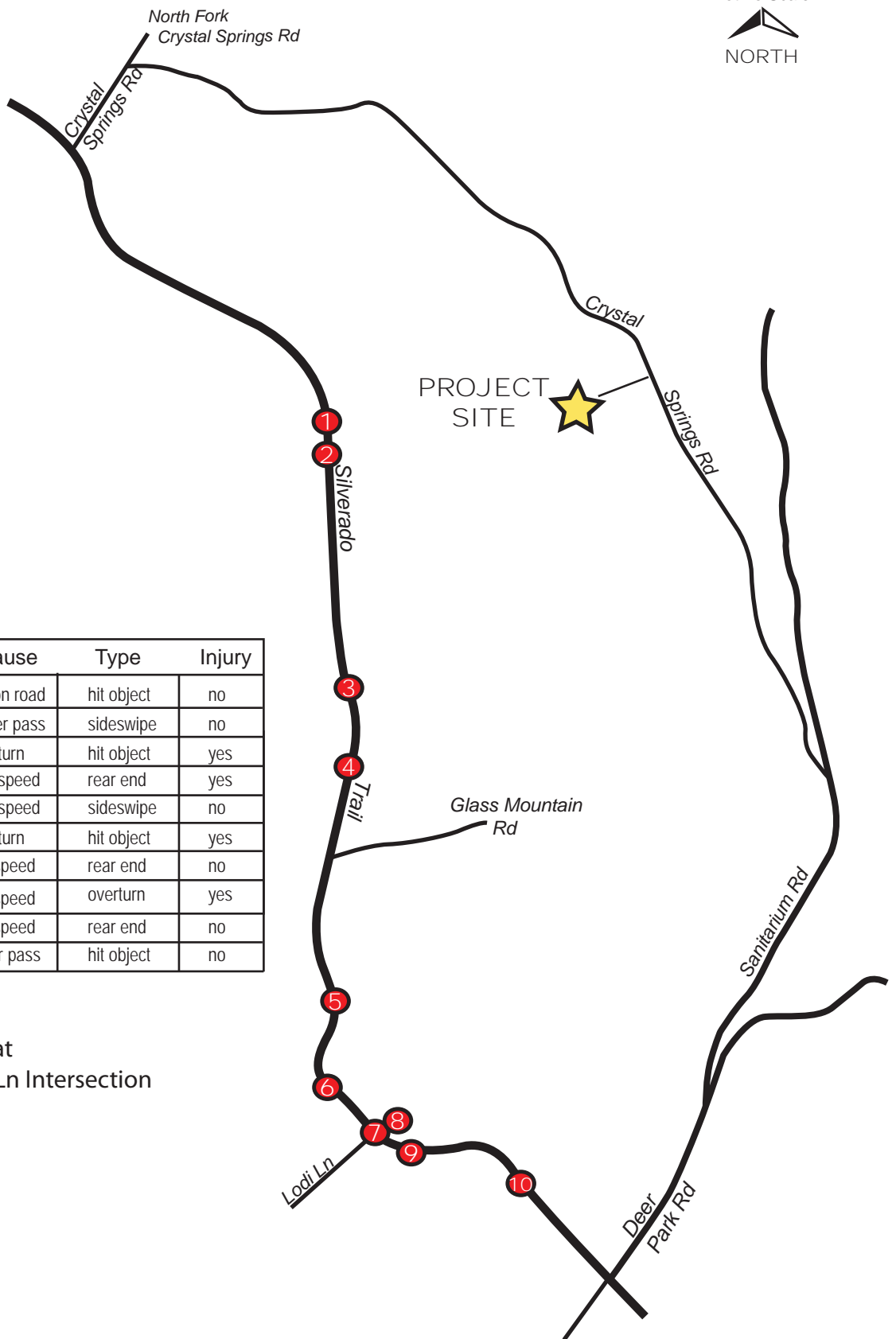

Vida Valiente Winery Use Permit 2020 Traffic Study

Figure D-1

Accidents in the Vicinity
 of the Project Site - 2014

Not To Scale

 NORTH

	# of veh	Cause	Type	Injury
①	2	improper pass	hit object	yes
②	1	impaired	hit object	no
③	1	not driver	hit object	no
④	2	wrong side	broadside	yes
⑤	2	right of way	broadside	no
⑥	1	unsafe speed	rear end	no
⑦	2	unsafe speed	hit object	yes
⑧	2	unsafe speed	rear end	no

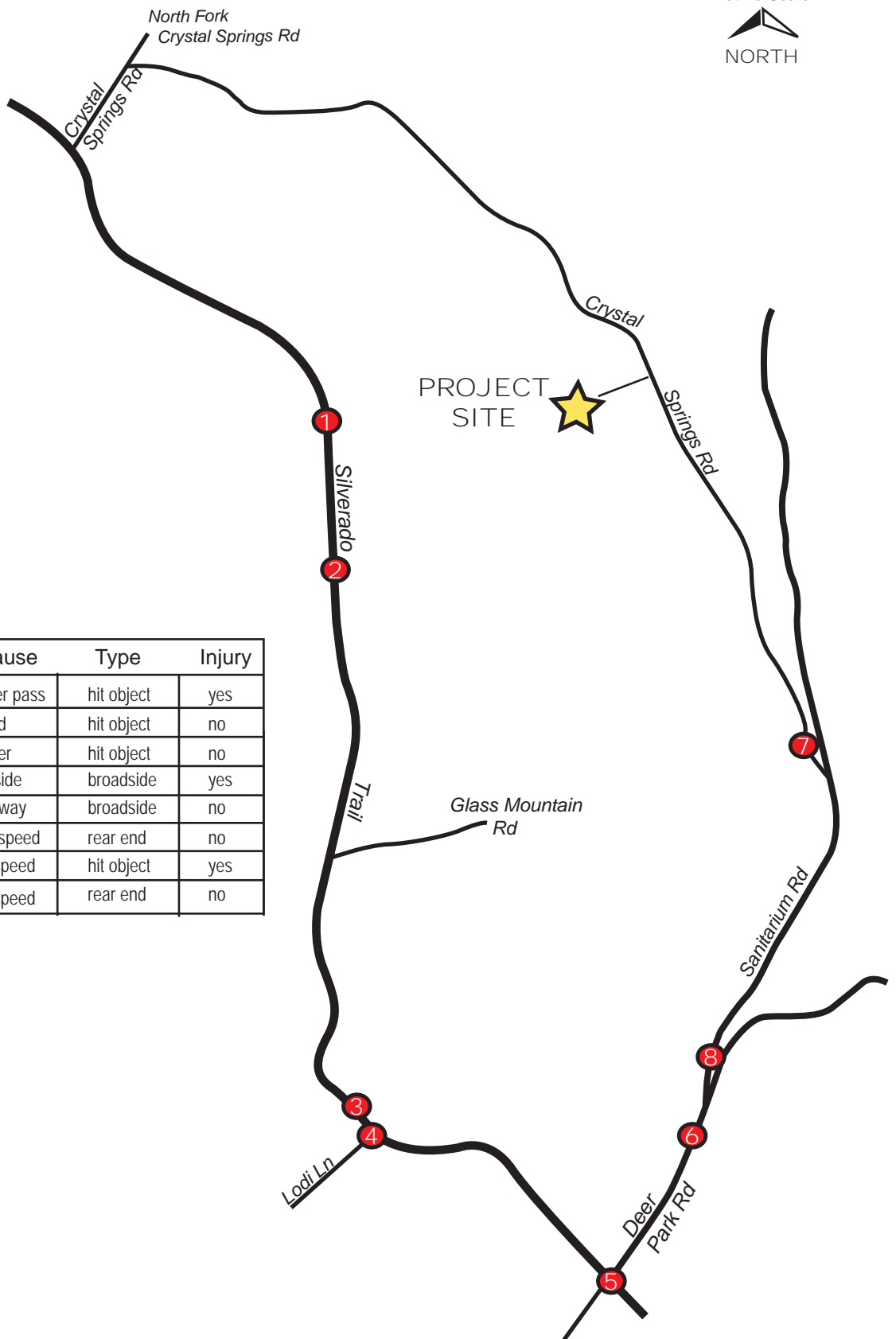

Vida Valiente Winery Use Permit 2020 Traffic Study

Figure D-2

Accidents in the Vicinity
 of the Project Site - 2015

Not To Scale

 NORTH

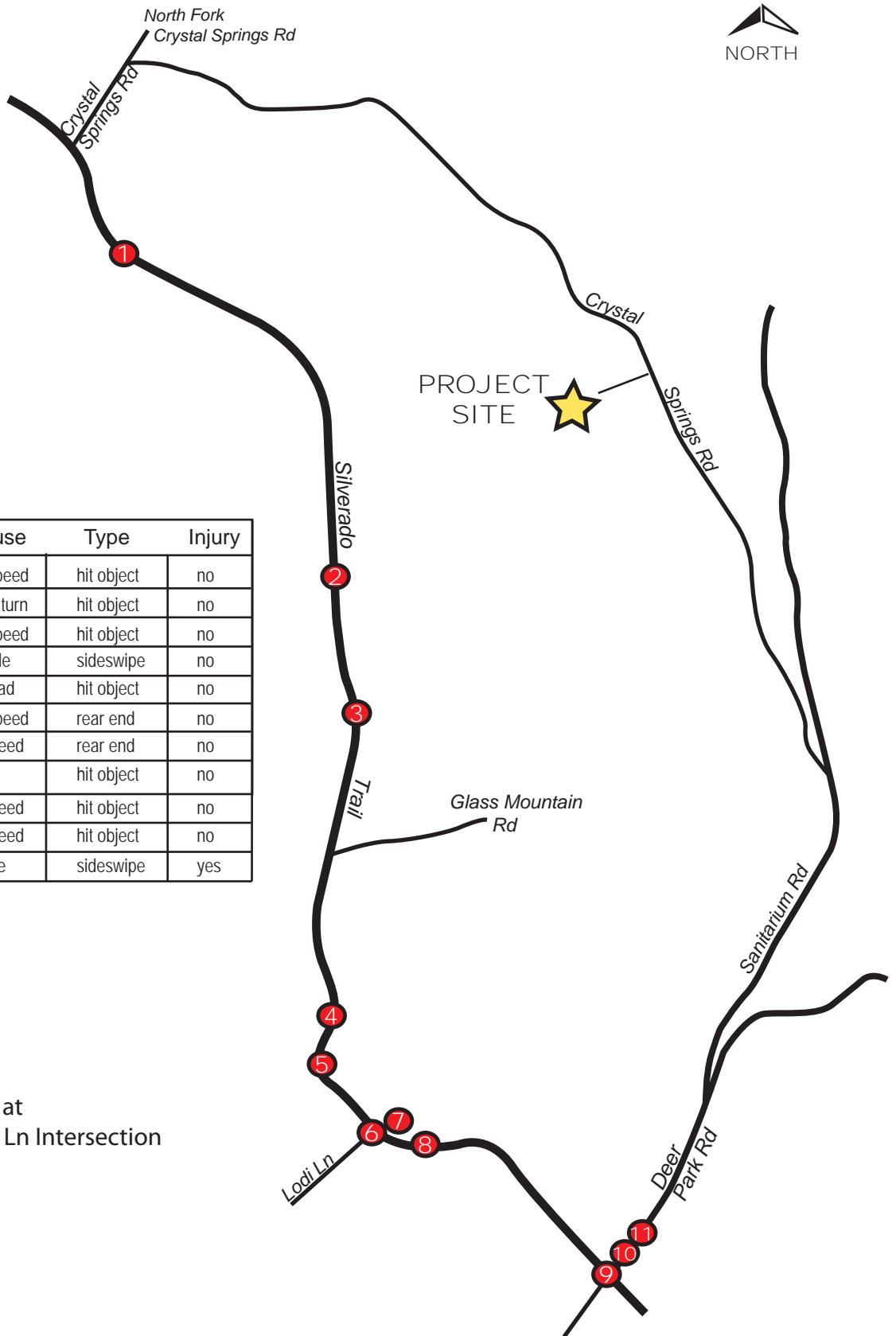

	# of veh	Cause	Type	Injury
①	1	unsafe speed	hit object	no
②	1	improper turn	hit object	no
③	1	unsafe speed	hit object	no
④	2	wrong side	sideswipe	no
⑤	2	ran off road	hit object	no
⑥	2	unsafe speed	rear end	no
⑦	2	unsafe speed	rear end	no
⑧	2	not driver	hit object	no
⑨	2	unsafe speed	hit object	no
⑩	1	unsafe speed	hit object	no
⑪	2	wrong side	sideswipe	yes

Accidents 6 & 7 are at Silverado Trail/Lodi Ln Intersection

Vida Valiente Winery Use Permit 2020 Traffic Study

Figure D-3

Accidents in the Vicinity of the Project Site - 2016

Not To Scale

 NORTH

	# of veh	Cause	Type	Injury
①	2	improper pass	sideswipe	yes
②	2	improper pass	sideswipe	no
③	1	unsafe speed	hit object	no
④	1	unsafe speed	hit object	no
⑤	1	improper turn	hit object	no
⑥	1	improper turn	hit object	no
⑦	2	right of way	broadside	no
⑧	2	right of way	broadside	yes
⑨	2	right of way	broadside	yes
⑩	2	right of way	broadside	yes
⑪	1	not driver	other	no
⑫	1	not driver	hit object	no

Accidents 7 & 8 are at Silverado Trail/Deer Park Rd Intersection

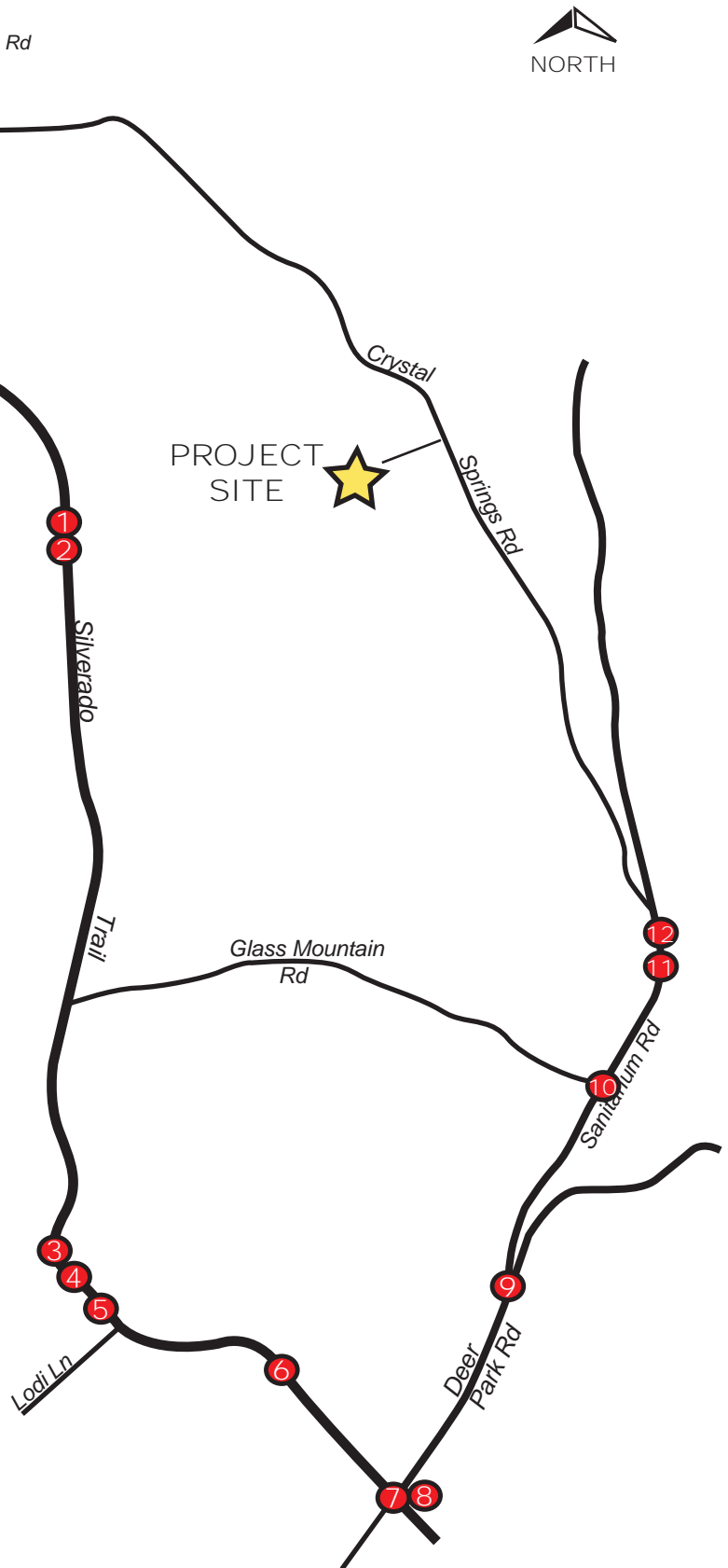

Vida Valiente Winery Use Permit 2020 Traffic Study

Figure D-4

Accidents in the Vicinity of the Project Site - 2017

Not To Scale

 NORTH

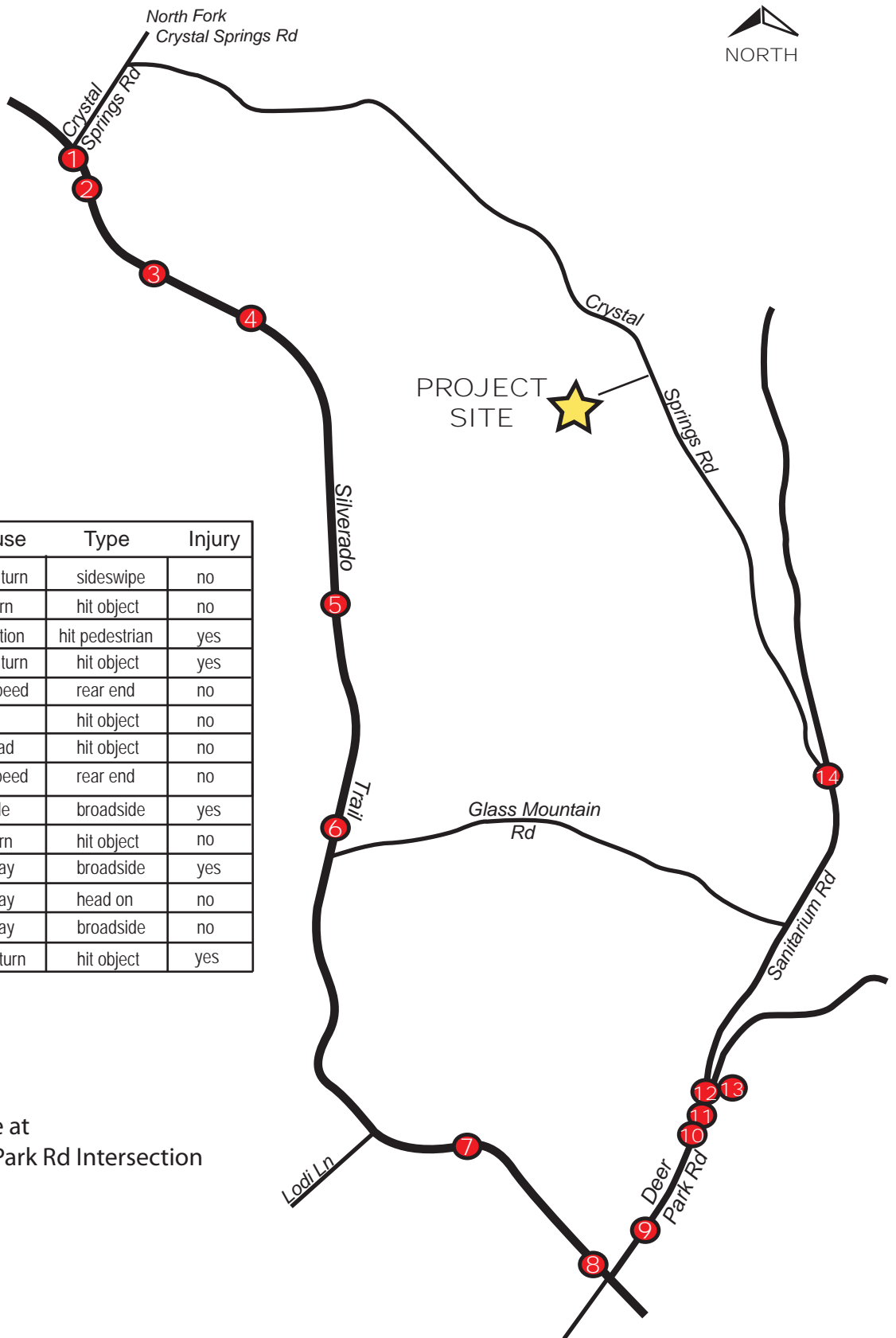

	# of veh	Cause	Type	Injury
①	2	improper turn	sideswipe	no
②	1	unsafe turn	hit object	no
③	1	Ped violation	hit pedestrian	yes
④	1	improper turn	hit object	yes
⑤	2	unsafe speed	rear end	no
⑥	1	impaired	hit object	no
⑦	1	ran off road	hit object	no
⑧	2	unsafe speed	rear end	no
⑨	2	wrong side	broadside	yes
⑩	1	unsafe turn	hit object	no
⑪	2	right of way	broadside	yes
⑫	2	right of way	head on	no
⑬	2	right of way	broadside	no
⑭	1	improper turn	hit object	yes

Accidents 12 & 13 are at Sanitarium Rd/Deer Park Rd Intersection

Vida Valiente Winery Use Permit 2020 Traffic Study

Figure D-5
 Accidents in the Vicinity of the Project Site - 2018

Not To Scale

 NORTH

	# of veh	Cause	Type	Injury
1	2	unsafe speed	rear end	no
2	1	unsafe speed	hit object	no
3	2	unsafe speed	rear end	no
4	2	improper turn	broadside	no
5	1	ran off road	hit object	no
6	1	impaired	hit object	no
7	1	unsafe turn	hit object	no
8	2	improper turn	sideswipe	no
9	1	unsafe turn	rollover	yes
10	1	unsafe turn	hit object	no
11	2	unsafe speed	rear end	no

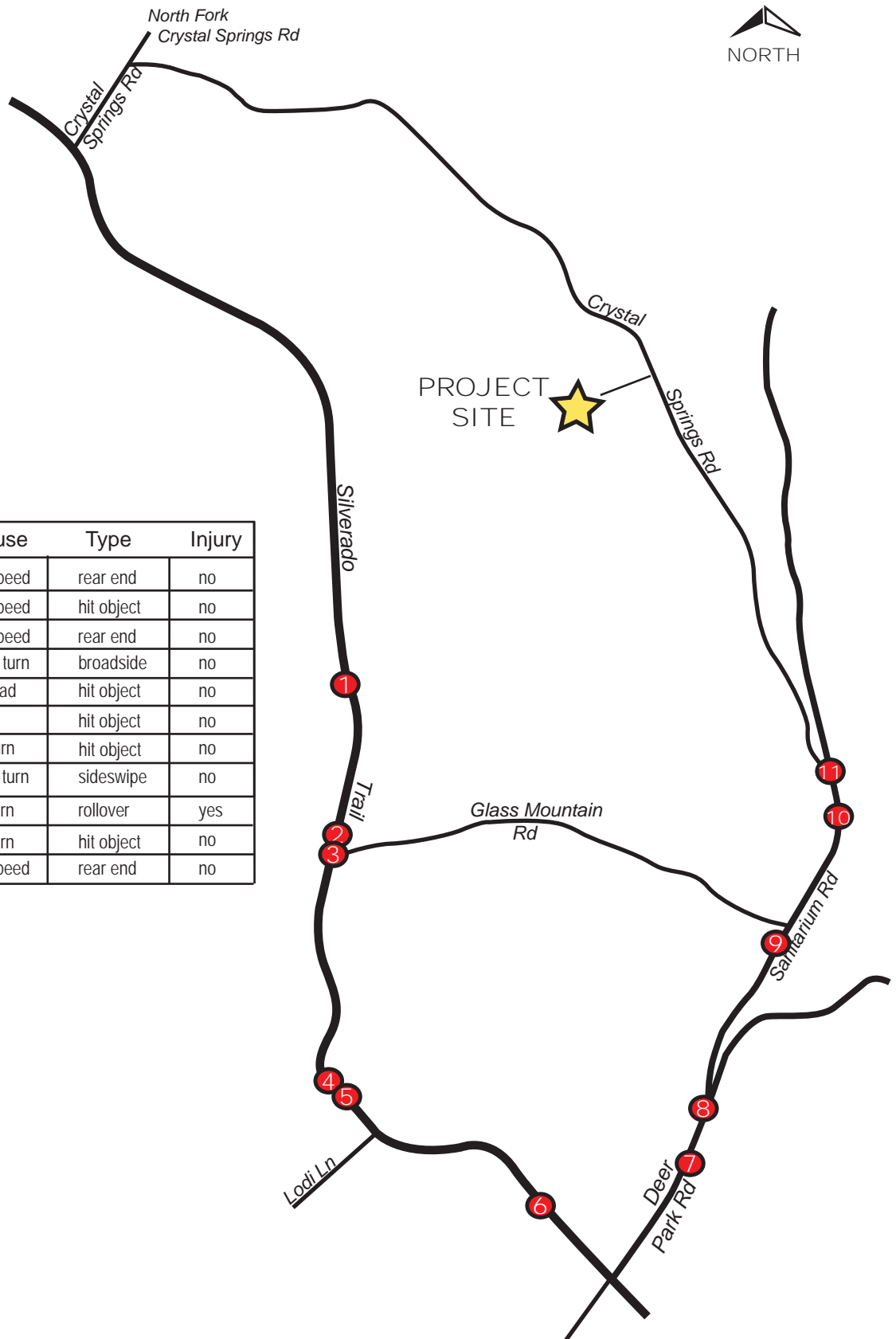

Vida Valiente Winery Use Permit 2020 Traffic Study

Figure D-6

Accidents in the Vicinity
 of the Project Site - 2019

A P P E N D I X E

**DAKOTA SHY WINERY DRIVEWAY
Friday Hourly Percent of Total Trips**

Friday, January 31, 2020

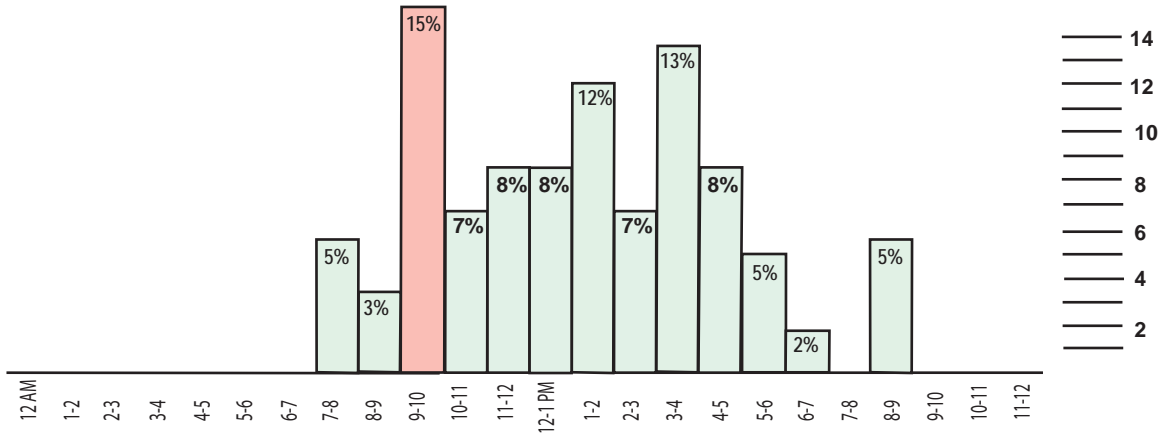

Friday, January 31, 2020
Total In/Out - 59 Vehicles

**DAKOTA SHY WINERY DRIVEWAY
Friday Hourly Percent of Total Trips**

Friday, February 7, 2020

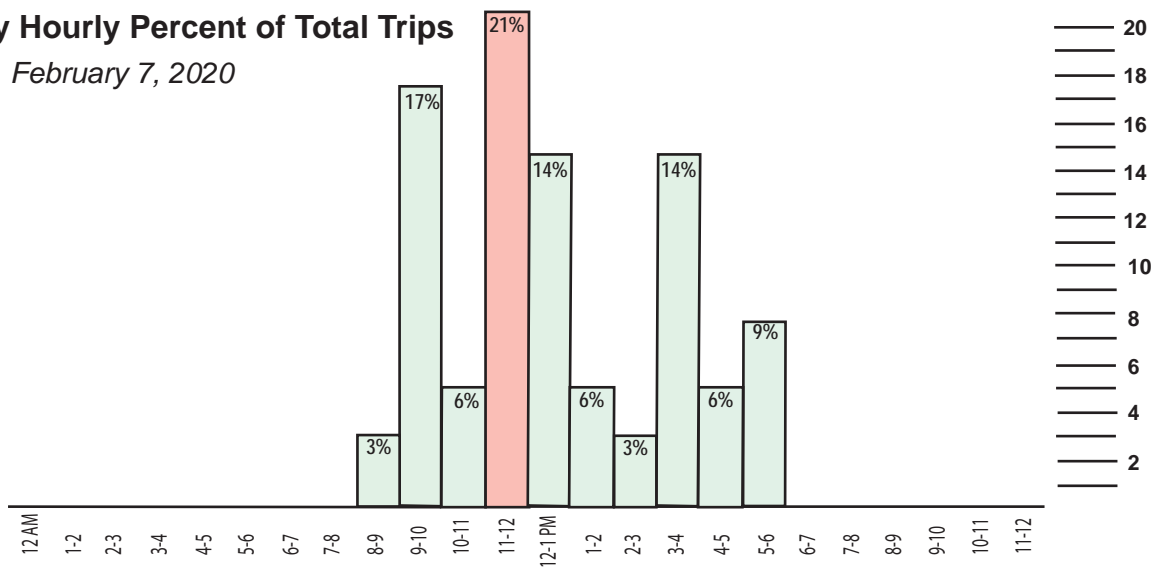

Friday, February 7, 2020
Total In/Out - 34 Vehicles

Figure E-1
Dakota Shy Vineyard Friday Traffic Percentages
(by Hour) - January 31 and February 7, 2020

**DAKOTA SHY WINERY DRIVEWAY
Saturday Hourly Percent of Total Trips**

Saturday, February 1, 2020

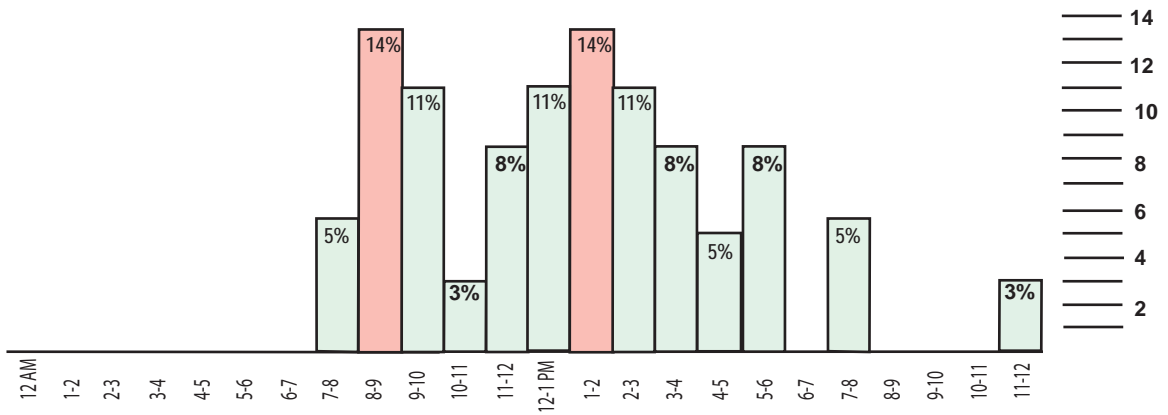

Saturday, February 1, 2020
Total In/Out - 37 Vehicles

**DAKOTA SHY WINERY DRIVEWAY
Saturday Hourly Percent of Total Trips**

Saturday, February 8, 2020

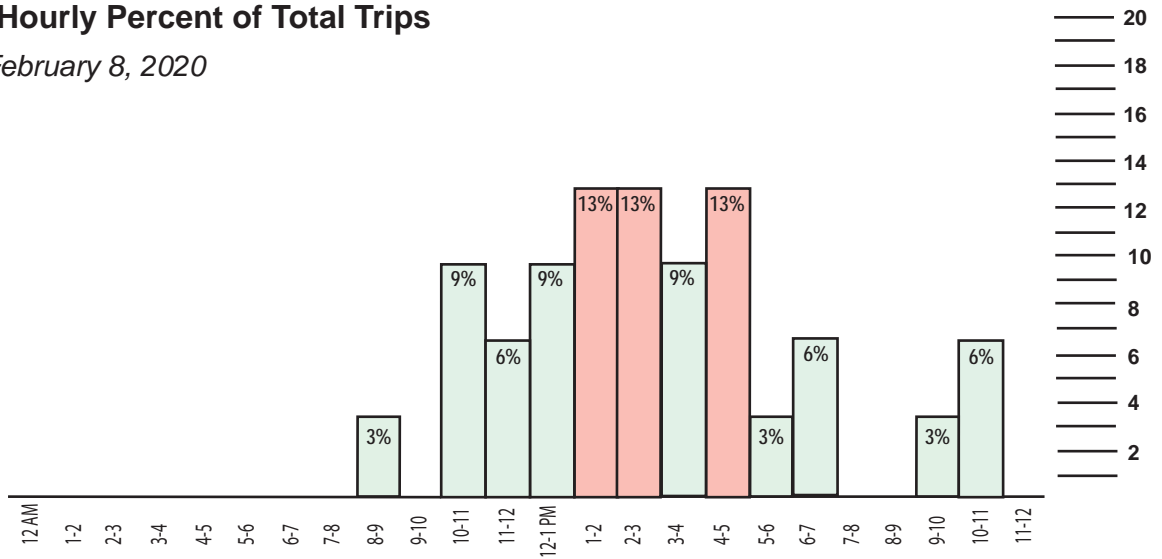

Saturday, February 8, 2020
Total In/Out - 31 Vehicles

Figure E-2

Dakota Shy Vineyard Saturday Traffic Percentages
(by Hour) - February 1 and February 8, 2020

WHEELER FARMS WINERY DRIVEWAY
Friday Hourly Percent of TOTAL Trips

October 18, 2019

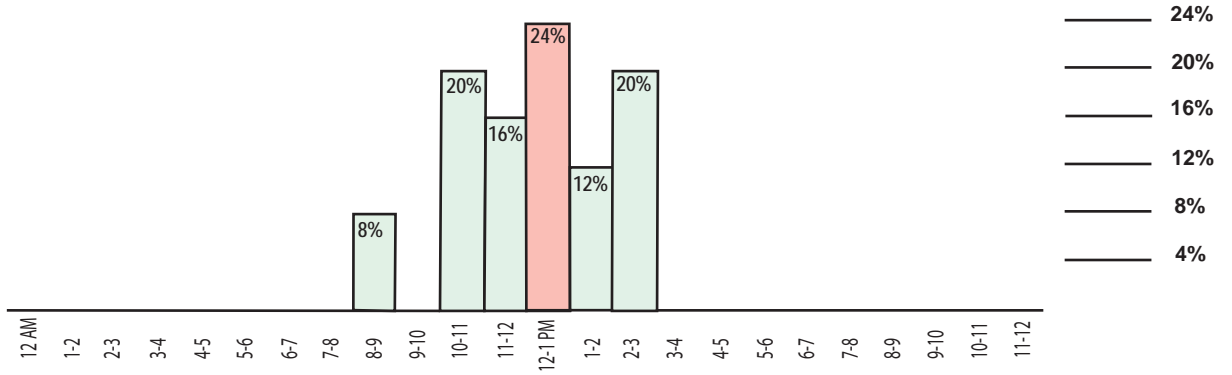

Friday, October 18, 2019
 Total In/Out - 25 Vehicles

WHEELER FARMS WINERY DRIVEWAY
Friday Hourly Percent of TOTAL Trips

October 25, 2019

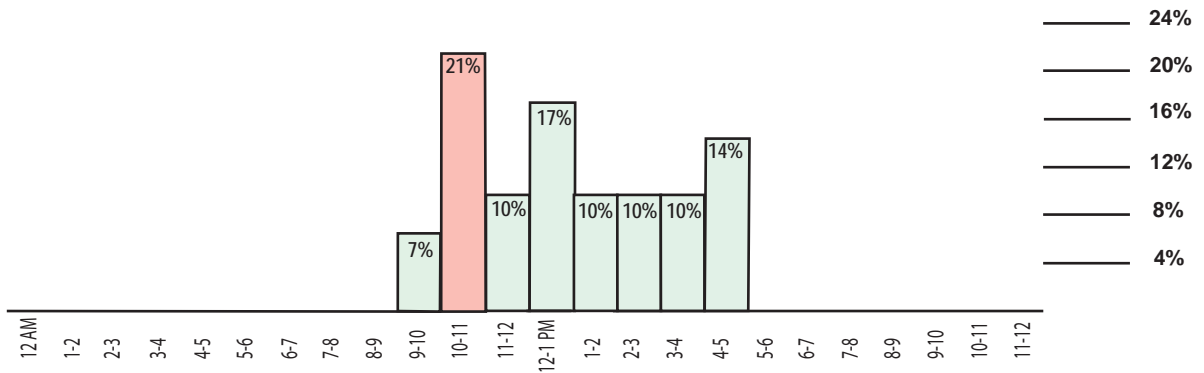

Friday, October 25, 2019
 Total In/Out - 29 Vehicles

Figure E-3

Wheeler Farms Winery Friday Traffic Percentages
 (by Hour) - October 18 and October 25, 2019

WHEELER FARMS WINERY DRIVEWAY
Saturday Hourly Percent of TOTAL Trips
October 19, 2019

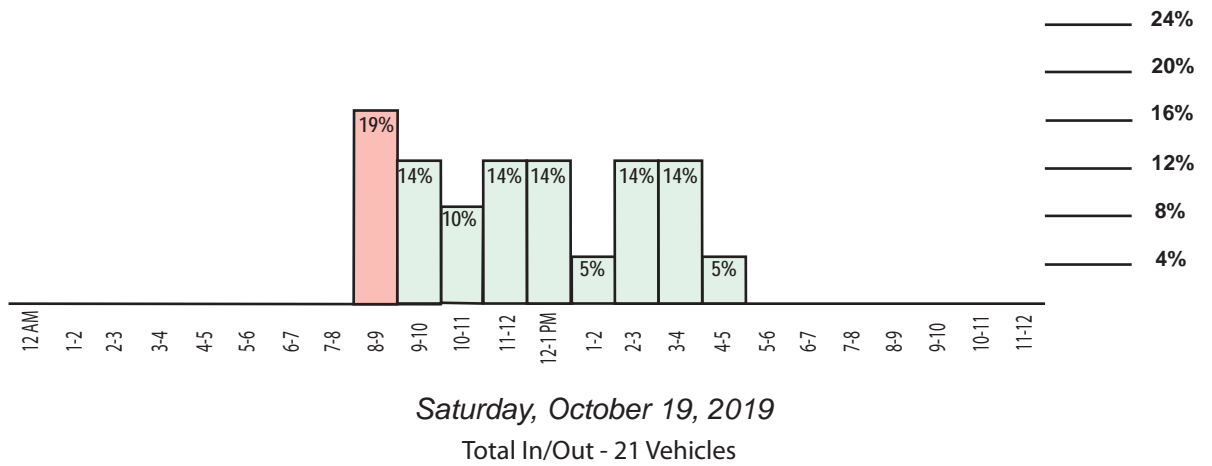

WHEELER FARMS WINERY DRIVEWAY
Saturday Hourly Percent of TOTAL Trips
October 26, 2019

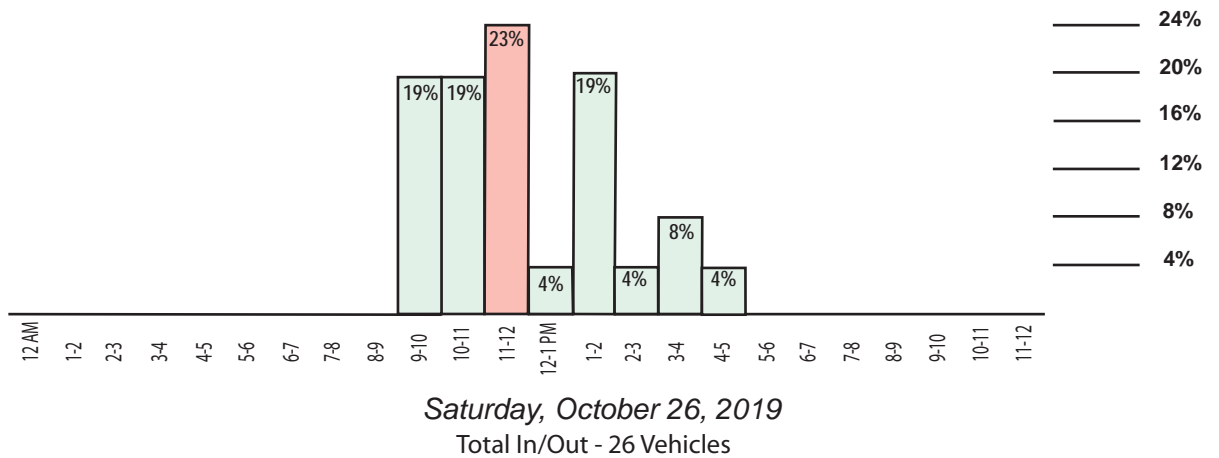
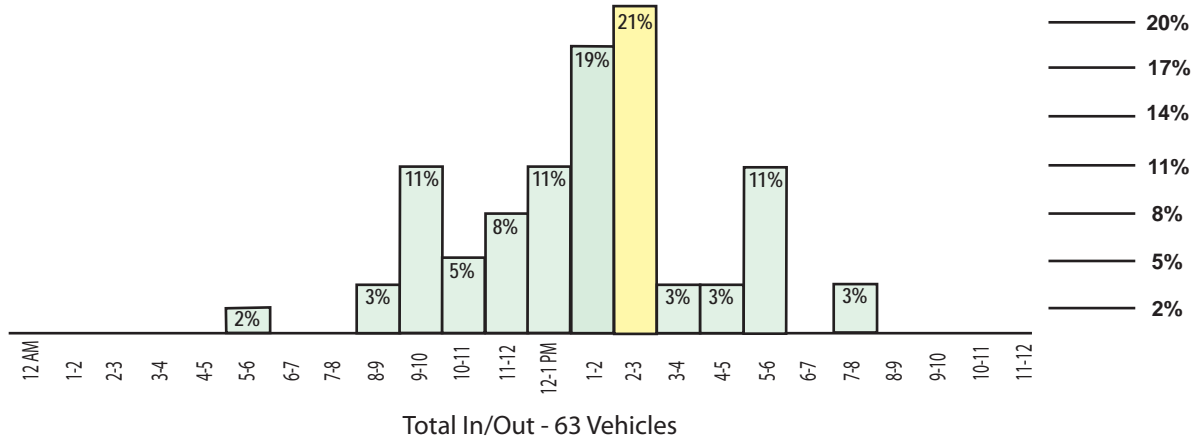

Figure E-4

Wheeler Farms Winery Saturday Traffic Percentages
 (by Hour) - October 19 and October 26, 2019

MATERRA WINERY DRIVEWAY
Friday Hourly Percent of Total Trips

Friday, October 23, 2020



MATERRA WINERY DRIVEWAY
Friday Hourly Percent of Total Trips

Friday, October 30, 2020

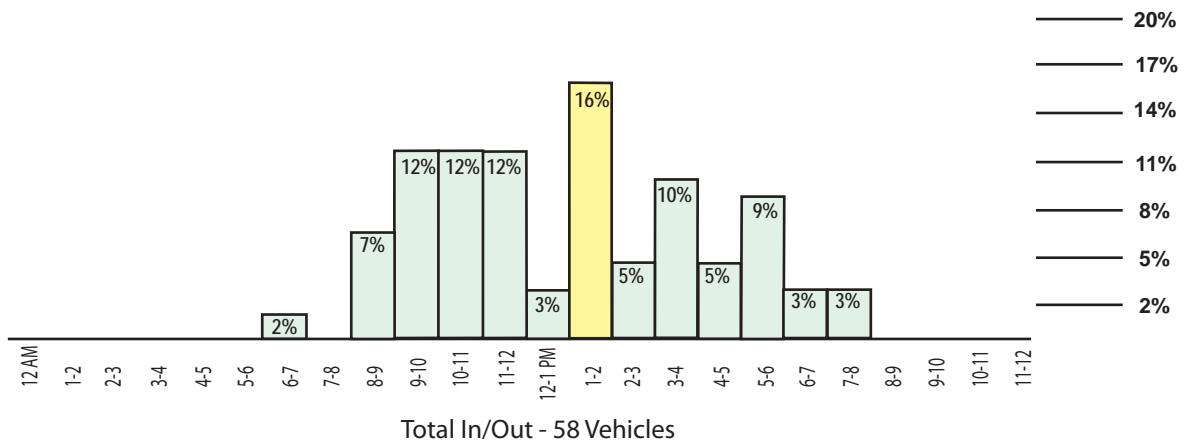
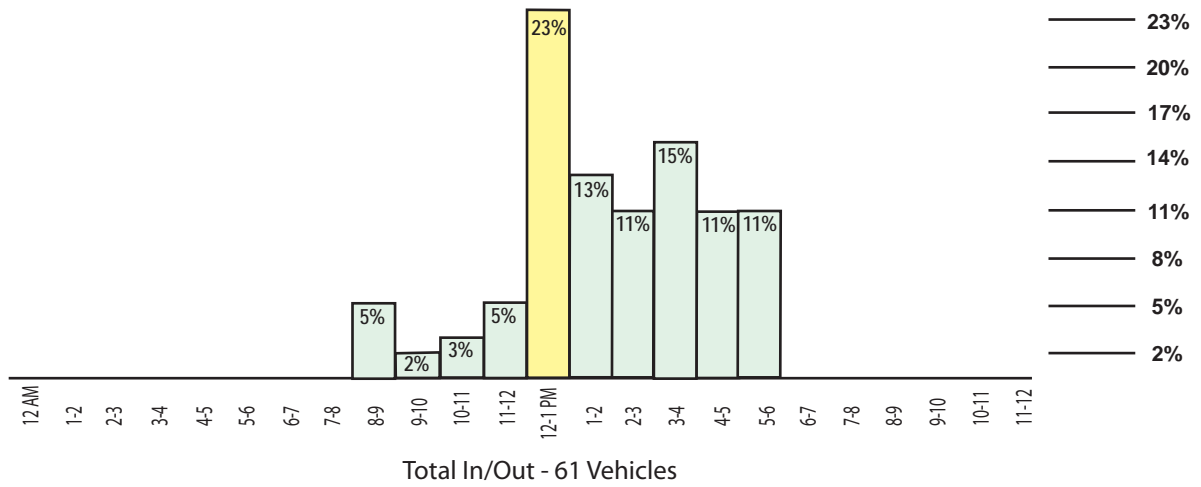

Figure E-5
 Materra Winery Friday Traffic Percentages
 (by Hour) - October 23 and October 30, 2020

MATERRA WINERY DRIVEWAY
Saturday Hourly Percent of Total Trips

Saturday, October 24, 2020



MATERRA WINERY DRIVEWAY
Saturday Hourly Percent of Total Trips

Saturday, October 31, 2020

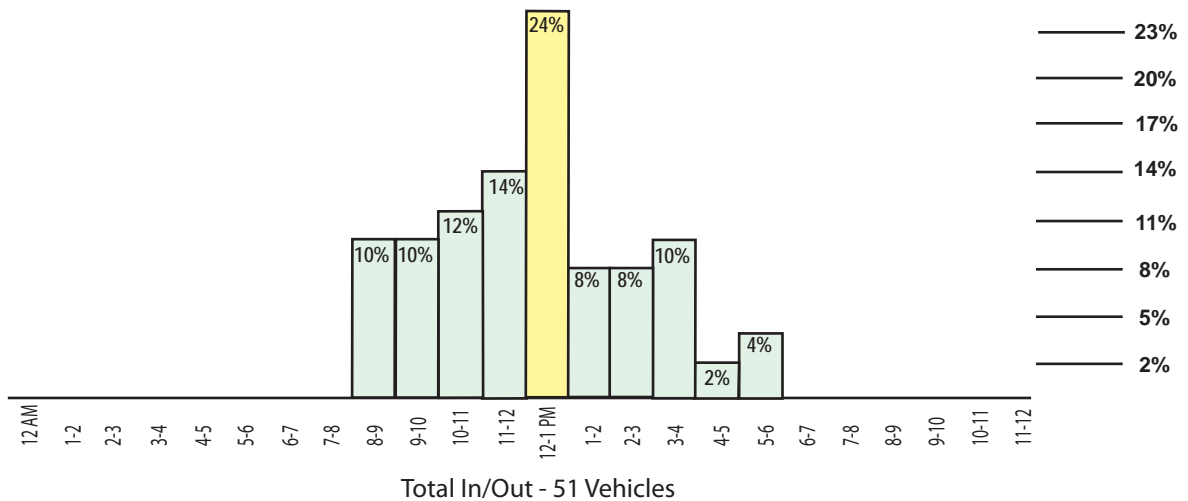

Figure E-6
 Materra Winery Saturday Traffic Percentages
 (by Hour) - October 24 and October 31, 2020



A Tradition of Stewardship
A Commitment to Service

WINERY TRIP GENERATION WORKSHEET

Planning, Building & Environmental Services

1195 Third Street, Suite 210

Napa, CA 94559-3082

(707) 253-4417

PROJECT DESCRIPTION

Winery Name: _____	Date Prepared: _____
---------------------------	-----------------------------

Existing Entitled Winery		Harvest	Non-Harvest
Number of Full Time Employees*	Weekday	_____	_____
	Weekend	_____	_____
Number of Part Time Employees*	Weekday	_____	_____
	Weekend	_____	_____
Maximum Daily Visitation	Weekday	_____	_____
	Weekend	_____	_____
Annual Gallons of Production		_____	_____
Annual Tons of Grape Haul		_____	N/A
Number of Visitors at the Largest Event that occurs two or more times per month, on average	Weekday	_____	_____
	Weekend	_____	_____

Proposed Winery		Harvest	Non-Harvest
Number of Full Time Employees*	Weekday	_____	_____
	Weekend	_____	_____
Number of Part Time Employees*	Weekday	_____	_____
	Weekend	_____	_____
Maximum Daily Visitation	Weekday	_____	_____
	Weekend	_____	_____
Annual Gallons of Production		_____	_____
Annual Tons of Grape Haul		_____	N/A
Number of Visitors at the Largest Event that occurs two or more times per month, on average	Weekday	_____	_____
	Weekend	_____	_____

*Number of full time and part time employees should represent the max number of employees that will be working on any given day (including all vendors and contractors employed for the largest event that occurs two or more times per month on average).

TRIP GENERATION

Existing Winery				Harvest	Non-Harvest
<u>Maximum Daily Weekday Traffic (Friday)</u>					
	<u>Harvest</u>	<u>Non-Harvest</u>			
FT Employees			3.05 one way trips/employee	FT Employee Daily Trips	
PT Employees			1.9 one way trips/employee	PT Employee Daily Trips	
Max Visitors			2.6 visitors/vehicle for 2 one way trips	Max Visitor Daily Trips	
Max Event			2.6 visitors/vehicle for 2 one way trips	Max Event Daily Trips	
Gallons of Production			0.000018 truck trips	Production Daily Trips	
Tons of Grape Haul#			0.013889 truck trips	Grape Haul Daily Trips	
			Total Weekday Daily Trips		
			Total Weekday Peak Hour Trips*		
<u>Maximum Daily Weekend Traffic (Saturday)</u>					
	<u>Harvest</u>	<u>Non-Harvest</u>			
FT Employees			3.05 one way trips/employee	FT Employee Daily Trips	
PT Employees			1.9 one way trips/employee	PT Employee Daily Trips	
Max Visitors			2.8 visitors/vehicle for 2 one way trips	Max Visitor Daily Trips	
Max Event			2.8 visitors/vehicle for 2 one way trips	Max Event Daily Trips	
Gallons of Production			0.000018 truck trips	Production Daily Trips	
Tons of Grape Haul#			0.013889 truck trips	Grape Haul Daily Trips	
			Total Weekend Daily Trips		
			Total Weekend Peak Hour Trips*		
<u>Maximum Annual Traffic</u>					
					Total Annual Trips**

Proposed Winery				Harvest	Non-Harvest
<u>Maximum Daily Weekday Traffic (Friday)</u>					
	<u>Harvest</u>	<u>Non-Harvest</u>			
FT Employees			3.05 one way trips/employee	FT Employee Daily Trips	
PT Employees			1.9 one way trips/employee	PT Employee Daily Trips	
Max Visitors			2.6 visitors/vehicle for 2 one way trips	Max Visitor Daily Trips	
Max Event			2.6 visitors/vehicle for 2 one way trips	Max Event Daily Trips	
Gallons of Production			0.000018 truck trips	Production Daily Trips	
Tons of Grape Haul#			0.013889 truck trips	Grape Haul Daily Trips	
			Total Weekday Daily Trips		
			Total Weekday Peak Hour Trips*		
<u>Maximum Daily Weekend Traffic (Saturday)</u>					
	<u>Harvest</u>	<u>Non-Harvest</u>			
FT Employees			3.05 one way trips/employee	FT Employee Daily Trips	
PT Employees			1.9 one way trips/employee	PT Employee Daily Trips	
Max Visitors			2.8 visitors/vehicle for 2 one way trips	Max Visitor Daily Trips	
Max Event			2.8 visitors/vehicle for 2 one way trips	Max Event Daily Trips	
Gallons of Production			0.000018 truck trips	Production Daily Trips	
Tons of Grape Haul#			0.013889 truck trips	Grape Haul Daily Trips	
			Total Weekend Daily Trips		
			Total Weekend Peak Hour Trips*		
<u>Maximum Annual Traffic</u>					
					Total Annual Trips**

Net New Trips		Harvest	Non-Harvest
<u>Maximum Weekday Traffic (Friday)</u>			
If total net new daily trips is greater than 40, a TIS is required		Net New Weekday Daily Trips	
		Net New Weekday Peak Hour Trips*	
<u>Maximum Weekend Traffic (Saturday)</u>			
If total net new daily trips is greater than 40, a TIS is required		Net New Weekend Daily Trips	
		Net New Weekend Peak Hour Trips*	
<u>Maximum Annual Traffic</u>			
		Net New Annual Trips**	

#Trips associated with Grape Haul represent harvest season only.

*Weekday peak hour trips are calculated as 38% of daily trips associated with visitors and production plus one trip per employee. Weekend peak hour trips are calculated as 57% of daily trips associated with visitors and production plus one trip per employee.

**Annual trips represent a conservative calculation that assumes 11 weeks of harvest, all weekdays are Fridays, all weekends are Saturdays, and assumes that the largest event that occurs two or more times per month on average occurs every day.

**A
P
P
E
N
D
I
X

F**

COUNTY of NAPA LEFT TURN WARRANT GRAPH at Private Road and Driveway Intersections

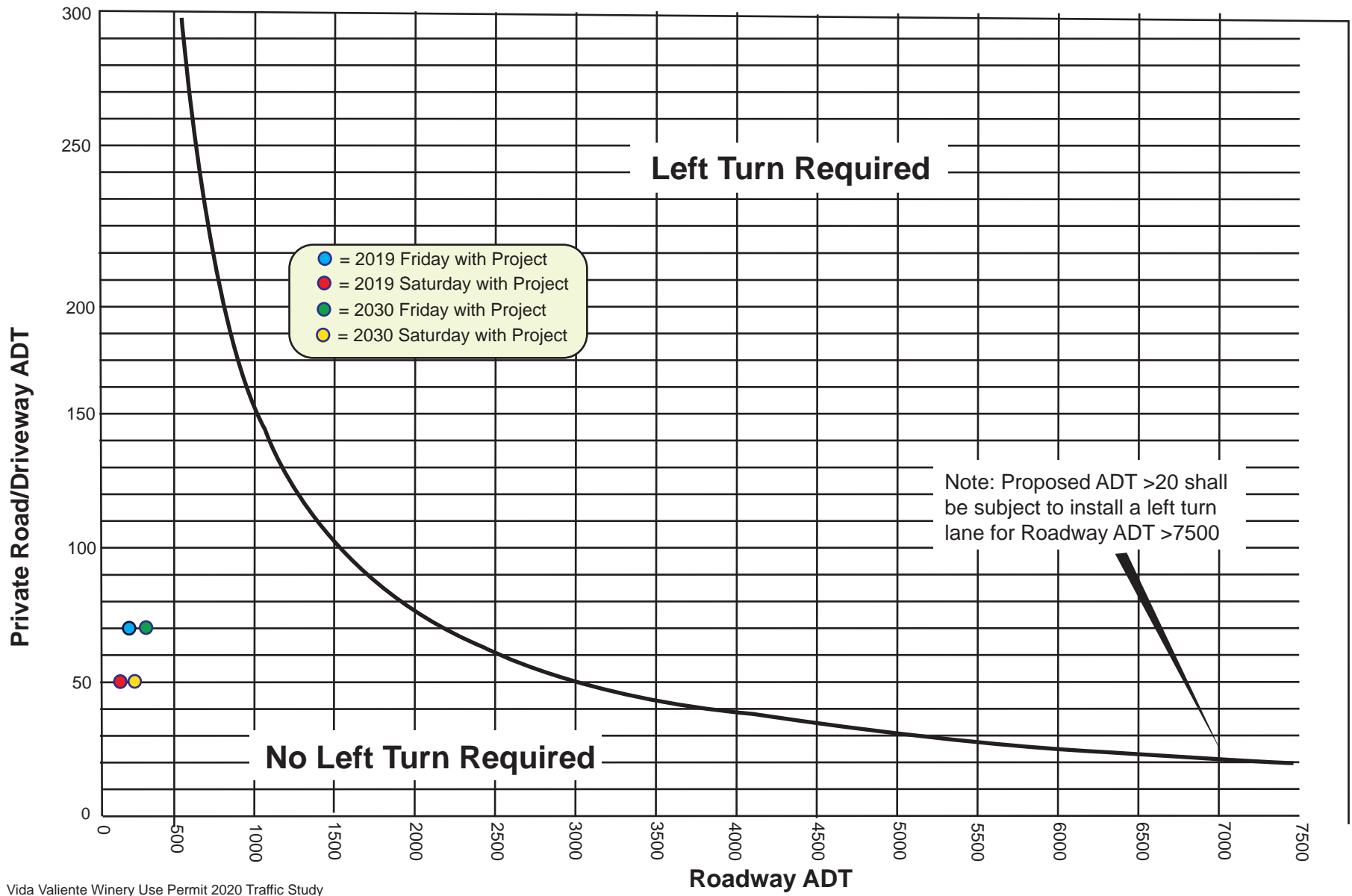

Vida Valiente Winery Use Permit 2020 Traffic Study



Appendix Figure F-1

COUNTY of NAPA LEFT TURN WARRANT GRAPH Left Turn from Crystal Springs Road to Project Driveway

A P P E N D I X G

VIDA VALIENTE WINERY

TRANSPORTATION DEMAND MANAGEMENT (TDM) PROGRAM

Napa County requires the inclusion of a Transportation Demand Management (TDM) Program with each Winery Use Permit for the purpose of reducing the Vehicle Miles Traveled (VMT) to and from the Winery. The TDM Program will be included as a Condition of Approval to the winery use permit and the Program will be implemented by the applicant. The goal of the TDM Program is to reduce Winery trip generation by 15 % compared to operation without a TDM program in operation.

This is a very small Winery, so measures have been developed in consideration of scale.

Program:

1. The Winery will appoint a staff person designated as the TDM Program coordinator. The role of the coordinator will facilitate employees reducing solo-vehicle commuting and to report to County staff on January 15th of each year (annual basis) on the status of the strategies implemented.
2. Financial incentives will be provided for employees to participate in carpools and vanpools.
3. Electric car charging station will be provided to serve employees and Winery guests.
4. Bicycle racks and storage areas will be provided for Winery employees and guests.
5. High occupancy vehicles (HOV), which include vans and shuttle buses, will be encouraged for larger marketing events.
6. Employee work hours will be staggered to the extent possible in order to avoid congestion during the peak traffic hours on Silverado Trail.
7. Remote location and work-at-home opportunities will be offered to the extent possible.
8. Winery visitor appointments will be scheduled, to the extent possible, during times that avoid peak hour traffic on Silverado Trail.
9. The Winery will enroll in "Napa Valley Forward," a program aimed at reducing traffic along major roads in the Napa Valley. This will be accomplished by the promotion of carpooling, vanpooling, bicycle commuting and the use of public transit systems as available.
10. The Winery will enroll in the "Bay Area Commuter Benefits Program," where employees report their carpooling activities and receive company-paid subsidies.
11. The Winery will prepare an Annual Performance Review and provide to Napa County.
12. Bicycle parking spaces will be provided as per the Napa County Municipal Code 18.110.040.
13. There will be no parking within the public right-of-way that is associated with any of the Winery hospitality events, including larger marketing events. All parking will be accommodated on-site or shuttles will be provided from off-site legal parking areas.